



ACHIEVING ASSEMBLY EXCELLENCE  
2023  
WWW.AIMCO-GLOBAL.COM



**TOOLimpex**  
CZECH REPUBLIC s.r.o.



For more than 50 years, AIMCO has been working with manufacturers around the world. We are the complete global source for all critical fastening and bolting solutions. AIMCO can effectively and swiftly meet your needs whether you're in Tennessee, USA fastening a 3 mm nut at 3 Nm, or in Denmark servicing wind-turbine bolts at 17,000 Nm. AIMCO provides the tools and solutions, on a global scale, that guarantee the success of your project. It is with great pride that AIMCO can say the products that we manufacture are **DESIGNED AND ASSEMBLED IN THE USA.**

# TABLE OF CONTENTS

## CONTROLLED TOOLS

### AcraDyne®

GEN IV ACE Controller Platform . . . . .	7
Controller Software . . . . .	14
GEN IV Smart Arm System with Process Visualization . . . . .	15
1000 Series Nutrunners . . . . .	17
2000 Series Nutrunners . . . . .	20
2000 Series AcraDrive Discontinuous Drive Nutrunners . . . . .	24
3000 Series Nutrunners . . . . .	26
5000 Series Nutrunners . . . . .	28
AcraDyne Specialty Gearheads . . . . .	31
Riv-Nut Tools . . . . .	32
HT Series DC Tools . . . . .	33
HT Series DC Angle Tools . . . . .	35
HT Series DC Dual-Lever Tools . . . . .	38
HTXD Extreme Duty High-Torque Tools . . . . .	40
Gen IV Field Controller . . . . .	43
HT Series Nose Extensions and Gearhead Tools . . . . .	44
HT Series DC Tool Accessories . . . . .	45
DC Tool / Spindle Selection Guide . . . . .	46
Cables and Accessories . . . . .	48
Cordless AB Series . . . . .	51
Cordless ABP Ultra Torque Series . . . . .	54
Multiple Nutrunning Systems . . . . .	56
AIMCO Tool Specials . . . . .	57

### Uryu

Pulse Tool Overview . . . . .	58
UA-MC / SMC Series . . . . .	59
UA-AMC Series . . . . .	60
Acra-Pulse® UXR MC / SMC Series . . . . .	61
UDP-MC Series . . . . .	61
UBX-AF Series . . . . .	62
Uryu UEC / UECP / UCC Controllers . . . . .	64
Controlled Pulse Tool Accessories . . . . .	70
Fixtured F-Series Nutrunners . . . . .	71

## TORQUE MEASUREMENT

Torque Measurement Overview . . . . .	75
Torque Measurement Systems . . . . .	78
Torque Measurement Testers . . . . .	79
Torque Measurement Analyzers . . . . .	82
Auditor Data Collection Software . . . . .	84
High-Capacity Test Stands . . . . .	86
Torque Wrenches . . . . .	90
iTVC Torque Carts . . . . .	94
Transducers . . . . .	95
Rundown Fixtures . . . . .	97
Joint Kits / Joint Simulators . . . . .	98
Torque Measurement Cables . . . . .	99

## POWER TOOLS

AcraDyne HT Series Pneumatic Tools . . . . .	100
Pulse Tools: Overview . . . . .	103
Omega Pulse: UAT Series . . . . .	104
Omega Pulse: UL / ULT Series . . . . .	106
Acra-Pulse® U / UX / UXR Series . . . . .	108
UTM Series Fastening Counter . . . . .	109
BP-T Pulse Series Cordless Tools . . . . .	110
UBX-T Series Cordless Pulse Tools . . . . .	112
ABETP XT Cordless Series . . . . .	114
UAN Series Angle Nutrunners . . . . .	116
URW Series Ratchet Wrenches . . . . .	117
UOW & UGW Tubenut and Geared Wrenches . . . . .	118
DynaTorque® Manual Torque Multipliers . . . . .	119
US-LT / US / US-LD Pneumatic Screwdrivers . . . . .	120
Signature Series® Shut-Off Impact Cordless Tools . . . . .	124
Signature Series® Precision Clutch Cordless Tools . . . . .	125
Electra® Series Electric Screwdrivers . . . . .	127
Impact Tools . . . . .	130
Grinders . . . . .	132
Sanders & Drills . . . . .	133
Percussion Tools . . . . .	134

## ASSEMBLY SYSTEMS

A-50 Screw Presenters . . . . .	135
Acra-Feed® Automatic Screw Feed Systems . . . . .	136

## TOOL SUPPORT SYSTEMS

Ergo Arms® . . . . .	137
Carbon Torque Arms . . . . .	139
Carbon Torque Tubes . . . . .	142
GCI Torque Reaction Arms . . . . .	144
3arm Zero Gravity Arms . . . . .	147
Support System Tool-Mounting Options . . . . .	152
Workstation Components And Assemblies . . . . .	153
Balancers / Retractors . . . . .	155
Air Preparation Units . . . . .	157
Air Line & Accessories . . . . .	158

## FASTENER TOOLS

Standard Fastener Tools . . . . .	160
Ergo-Drive® Series <b>E*</b> . . . . .	164
Custom / Special Parts . . . . .	166

Index . . . . .	169
-----------------	-----



\* **E** logo indicates where ERGO-DRIVE sockets/extensions benefit tool operation.

ERGO-DRIVE sockets are uniquely designed for repeatable, accurate rundowns. They also ensure excellent product quality, longer tool life, and better ergonomics for the tool user. Look for the ERGO-DRIVE **E** logo in this catalog to see where ERGO-DRIVE sockets/extensions benefit tool operation, operator, and rundown. See page 164 for ERGO-DRIVE details.



# WHAT IS IMPORTANT IN YOUR ASSEMBLY PROCESS?

Using AIMCO's industry standard PERQ formula guarantees that we will provide the best solution to fit your needs



## PRODUCTIVITY

Speed and efficiency of the assembly process

Whether a large automotive manufacturer building several hundred vehicles daily, or an electronics company producing individual, custom-made components, AIMCO provides products and services that allow each company to work at their ideal pace in order to keep its processes running efficiently.



## ERGONOMICS

Relationship between the worker and the assembly process

AIMCO focuses on providing products that are lightweight, quiet, and easy to operate, with minimal torque reaction and low vibration. These features allow assemblers to do their job in the safest possible manner and help manufacturers avoid the often hidden costs of workplace injuries.



## RELIABILITY

Reduced cost of repairing and maintaining the tools in the assembly process

AIMCO helps manufacturers face the challenges of maintenance, repair, and lost labor time by offering products with superior workmanship and durability. By combining high-quality products with a detailed and flexible service-training program, AIMCO ensures its tools will meet the customer's expectations of reliability.



## QUALITY

The ability of the tool to meet engineering requirements of the assembly process

AIMCO's assembly tools are tested and proven to meet the most stringent engineering specifications. AIMCO backs those tools up with its innovative Auditor torque measurement products. This allows manufacturers to focus on their most important goal – creating a quality product.



AIMCO and its distributors evaluate each manufacturer based on the PERQ formula to determine that company's unique blend of the PERQ elements – productivity, ergonomics, reliability, and quality. We then provide tooling options that enhance that mix. The end result is a manufacturing process that runs efficiently, produces high quality products and does so at the lowest possible cost. Combining PERQ with AIMCO's vast experience and unequalled service will enable any manufacturer to succeed in the global marketplace.

## Power Source

### ELECTRIC



- Clean and quiet
- Excellent torque repeatability because of slower speeds
- Greater flexibility at low torque ranges (<3 Nm)

### PNEUMATIC



- Fast operation
- Good power-to-weight ratio
- Long overall service life
- Allow more coverage at higher torque ranges (>200 Nm)

### CORDLESS



- Most flexibility for a broad range of applications
- No air hoses or cords to interfere with operator

## Drive Type

### DISCONTINUOUS



- Fast operation
- Virtually no torque reaction
- Frees up one hand for other, simultaneous tasks
- Superior clamp load repeatability

### CONTINUOUS



- Effective on a wide range of joint types from very hard to extremely soft
- Minimal maintenance
- Excellent torque repeatability because of slower speeds

## Orientation & Fixturing

### PISTOL



- Generally the quickest operation due to "point-and-tighten" familiarity

### INLINE



- Continuous drive inline tools normally require a reaction device for applications >2.5 Nm (20 in-lb)

### RIGHT ANGLE



- Good for low-clearance applications
- Continuous drive right angle tools allows highest possible torque ranges before reaction devices are required

### HANDHELD



- Normally the fastest to use on individual applications

### FIXTURED



- Can be fully automated, allowing operator to conduct other tasks as system operates

### MULTI-SPINDLE



- High productivity rates, but speed and cost may not be justified

## Correct Tool Choice



# Customer Commitment

## Tool University

AIMCO's commitment doesn't end with your tool purchase. Our goal is to educate you and your team on the most effective and efficient ways to utilize our tools; therefore, consistently producing a quality product.



All customers have the opportunity to attend our Tool University (Tool-U) training at our corporate headquarters in Portland, Oregon. Always free of charge to customers, your team will receive technical and practical training, learning how to effectively troubleshoot, test, and properly use the tool, which will reduce down time and help you achieve maximum tool performance.

AIMCO utilizes a team of experts to cover all elements influencing the fastening process, exploring the synergy between the joint, power tool, torque measurement, and operator handling. This knowledge can be applied to almost any assembly process regardless of the tool brand.

## Service



### Cutting-Edge Knowledge Base

Our skilled technicians work closely with our Technical Services group as well as our expert team of engineers, to share knowledge, keep up with new technologies, and improve processes.



### Service Guarantee

When AIMCO receives tools and equipment for servicing, they are pre-tested and inspected to identify issues. We provide precise repair estimates and feedback so that the customer ensures they are getting the most out of their tool investment. Repairs are completed using factory standards, parts, and processes. Once a repair is complete, it is tested, and/or calibrated, using N.I.S.T. certified measuring equipment, and guaranteed to perform to factory specifications.



### Complete Support

AIMCO helps manufacturers face the challenges of maintenance, repair, and lost labor time by offering products with superior workmanship and durability. By combining high-quality products with a detailed and flexible service-training program, AIMCO ensures its tools will meet the expectations of reliability. AIMCO backs those tools with its innovative Auditor torque measurement products. This allows manufacturers to focus on their most important goal – satisfied customers.

# AcraDyne Gen IV ACE Controller Platform



AcraDyne's Gen IV ACE Controller platform is a single platform that commands all transducerized tools in the AIMCO portfolio

AIR | CORDLESS | ELECTRIC



The same, simple programming for all tool types, including:

#### AcraDyne

- DC Tools
- Cordless Battery Tools

#### Uryu

- Air Powered Tools
- Electric Tools
- Pulse Tools

No additional controller training needed for different platforms (tool type specific knowledge is required).

One common communication for global data collection, line controls, and Field Bus platforms.



# AcraDyne Gen IV ACE Controller Platform

The AcraDyne Gen IV ACE controller platform is the culmination of more than 50 years of serving our industrial fastening customers with 20 years of manufacturing DC tools that are DESIGNED AND ASSEMBLED IN THE USA. It is filled with countless advanced capabilities and features. The Gen IV ACE Controller is the core of the modular AcraDyne DC system. One controller will command any tool in the AcraDyne line from 1 Nm to 17,000 Nm, all with one cable.

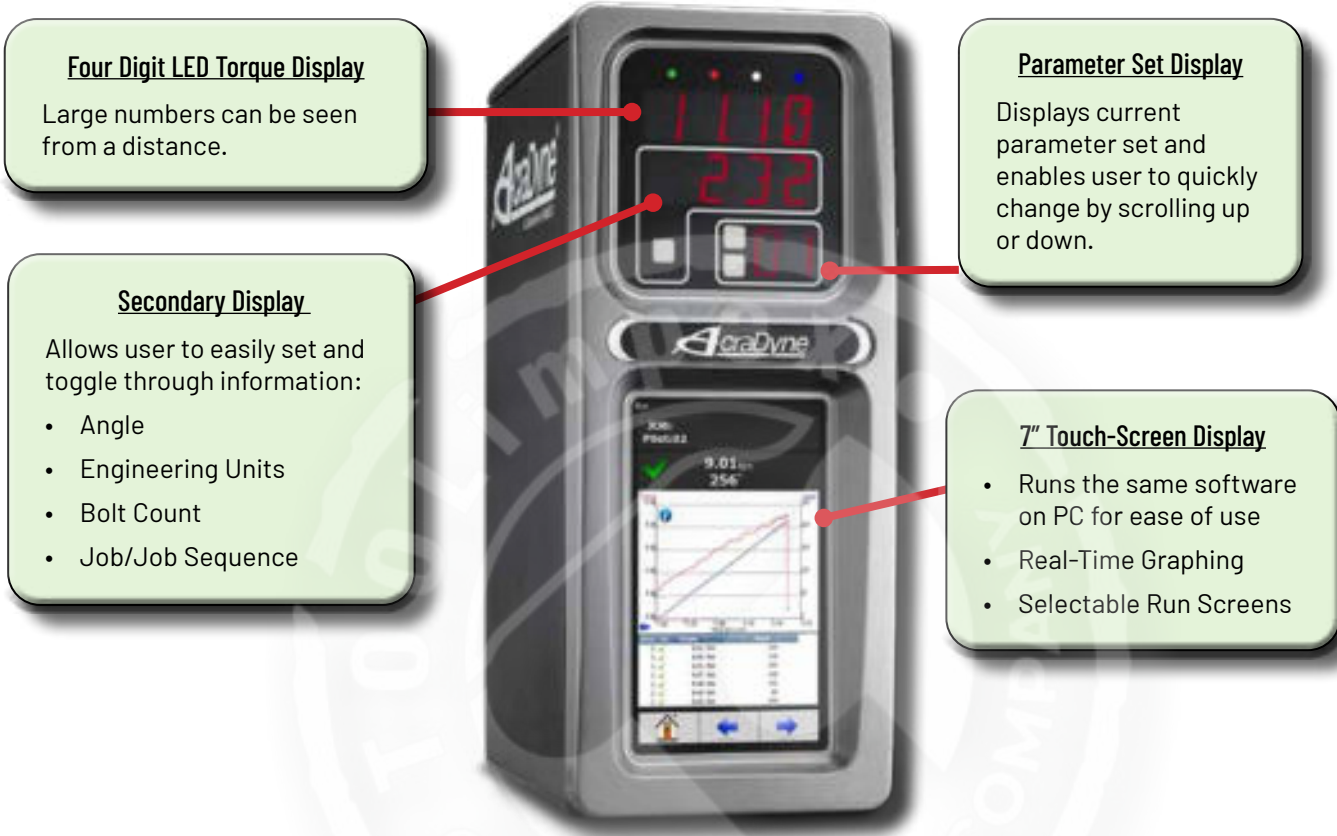

## FEATURES AND BENEFITS

- Web browser based programming. Receive data on your PC, tablet, smartphone, or any other web-capable device. You can use more than one device at a time: Be in program mode on one device while reviewing real-time curves on another, while watching tool diagnostics on a third
- Multiple fastening strategies - Program up to 256 parameters with as many as 20 steps
- Jobs capability - 99. Event log - 5,000
- Backup & restore through USB or Ethernet
- Assignable I/O (8 X 8)
- Rundown storage - 1,000,000
- Real-time curve viewing. Curve storage - 20,000

## NETWORKING CAPABILITIES

- Ethernet Protocols supported: Open Protocol, ToolsNet, Ethernet/IP, Modbus TCP, PFCS, XML, FTP Client
-  Anybus® Field Bus connectivity: Profibus, Profinet, DeviceNet, CC-Link, CC-Link IE Field
- Data collection
- Serial protocols and string output
- Bar code scanning & printing
- Multi-spindle synchronization



# AcraDyne Gen IV ACE Controller Platform

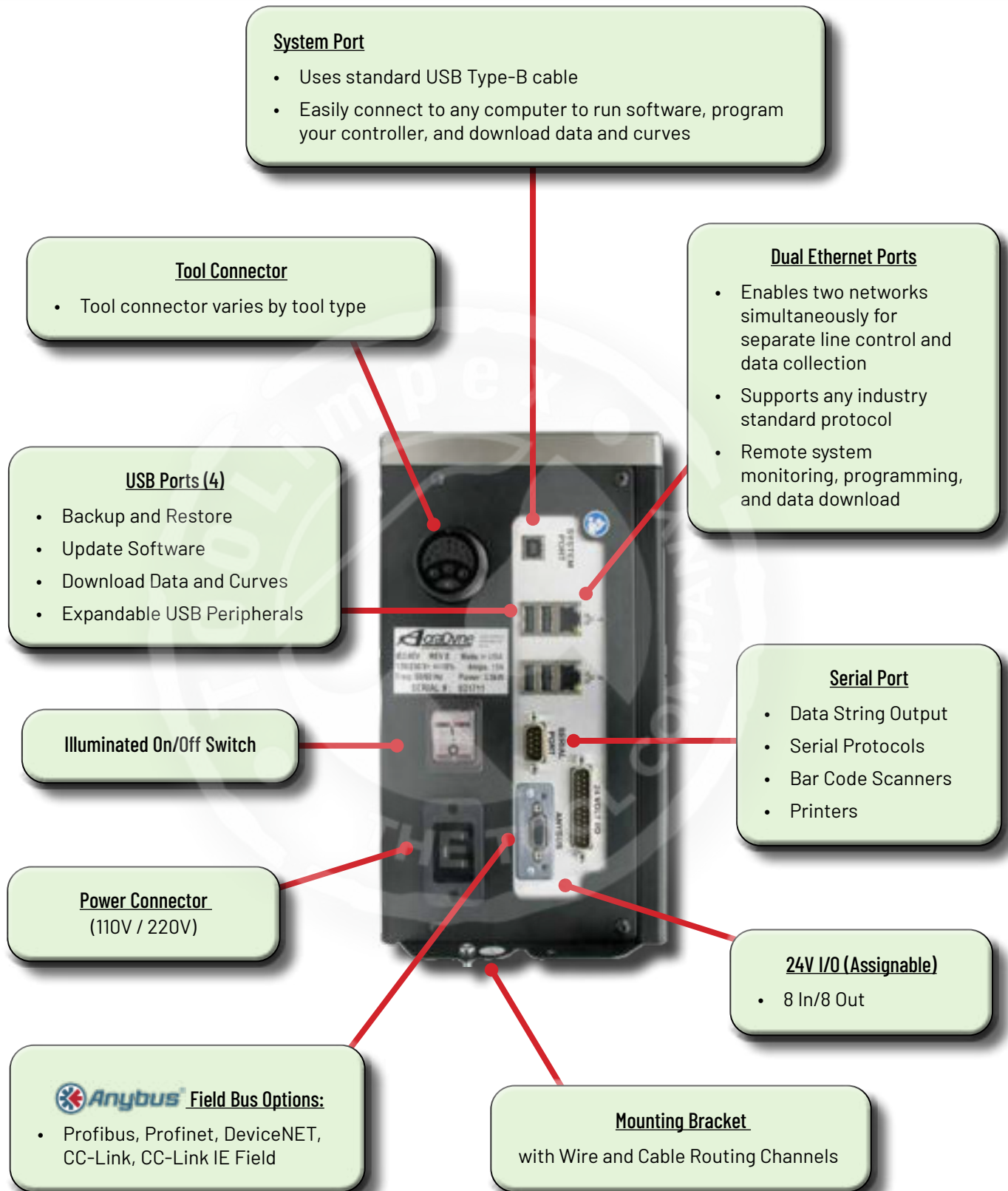

# AcraDyne Gen IV ACE Controller Platform

The Gen IV ACE Controller Platform provides ultimate FLEXIBILITY and FREEDOM to command tools for every application  
One common communication for your global data collection, line controls, and Field Bus platforms.



# AcraDyne Gen IV ACE Controller Platform



GEN IV ACE iEC Controller for all AcraDyne DC Tools



U.S. Patent D968491

Model*	System Port & Removable Memory	Lights (L) LED Display (D) Graph (G)	24V I/O Assignable 8 X 8"	Serial Port with Protocols	Backup & Restore (USB)	Ethernet** Two Ports
<b>Bottom Exit Cable</b>						
iEC4EGV(P)(N)(D)(C)(M)	X	L/D/G	X	X	X	X
<b>Top Exit Cable</b>						
iEC4EGV(-T)(P-T)(N-T)(D-T)(C-T)(M-T)	X	L/D/G	X	X	X	X

\* Field bus options: P = Profibus N = Profinet D = DeviceNet C = CC Link M = CC-Link IE Field Other Field bus options available upon request.  
 \*\* Ethernet channel supports Open Protocol, ToolsNet, EtherNet/IP, Modbus TCP, PFCS, XML, and FTP Client.



GEN IV ACE iAC Controller for Transducerized Uryu Air Tools



Model*	System Port & Removable Memory	Lights (L) LED Display (D) Graph (G)	24V I/O Assignable 8 X 8"	Serial Port With Protocols	Backup & Restore (USB)	Solenoid Shut Off On Board	Programmable Regulator On Board	Ethernet** Two Ports
<b>Bottom Exit Cable</b>								
iAC4EGV(P)(N)(D)(C)(M)	X	L/D/G	X	X	X			X
iAC4ESRGV(P)(N)(D)(C)	X	L/D/G	X	X	X	X	X	X
<b>Top Exit Cable</b>								
iAC4EV(P-T)	X	L/D	X	X	X			X
iAC4EGV(-T)(P-T)(N-T)(D-T)(C-T)	X	L/D/G	X	X	X			X
iAC4ESRGV(-T)(P-T)(N-T)(D-T)(C-T)	X	L/D/G	X	X	X	X	X	X

\* Field bus options: P = Profibus N = Profinet D = DeviceNet C = CC Link M = CC-Link IE Field Other Field bus options available upon request.  
 \*\* Ethernet channel supports Open Protocol, ToolsNet, EtherNet/IP, Modbus TCP, PFCS, XML, and FTP Client.

# AcraDyne Gen IV ACE Controller Platform



## GEN IV ACE iPC Controller for Uryu UDP Transducerized DC Pulse Tools



Model*	System Port & Removable Memory	Lights (L) LED Display (D) Graph (G)	24V I/O Assignable 8 X 8"	Serial Port with Protocols	Backup & Restore (USB)	Ethernet** Two Ports
<b>Bottom Exit Cable</b>						
<b>110V Operation</b> iPC4EGV(P1)(N1)(D1)(C1)(M1)	X	L/D/G	X	X	X	X
<b>220V Operation</b> iPC4EGV(P2)(N2)(D2)(C2)	X	L/D/G	X	X	X	X
<b>Top Exit Cable</b>						
<b>110V Operation</b> iPC4EGV(1-T)(P1-T)(N1-T)(D1-T)(C1-T)(M1-T)	X	L/D/G	X	X	X	X
<b>220V Operation</b> iPC4EGV(2-T)(P2-T)(N2-T)(D2-T)(C2-T)	X	L/D/G	X	X	X	X

\* Field bus options: P = Profibus N = Profinet D = DeviceNet C = CC Link M = CC-Link IE Field Other Field bus options available upon request.  
\*\* Ethernet channel supports Open Protocol, ToolsNet, EtherNet/IP, Modbus TCP, PFCS, XML, and FTP Client.



## GEN IV ACE iBC Controller for all AcraDyne Transducerized Battery Tools



Model*	System Port & Removable Memory	Lights (L) LED Display (D) Graph (G)	24V I/O Assignable 8 X 8"	Serial Port with Protocols	Backup & Restore (USB)	Ethernet** Two Ports
<b>Connects through External WiFi Access Point (User Supplied)</b>						
iBC4E(N)	X	L/D		X	X	X
iBC4EGV(P)(N)(D)(C)	X	L/D	X	X	X	X

\* Field bus options: P = Profibus N = Profinet D = DeviceNet C = CC Link M = CC-Link IE Field Other Field bus options available upon request.  
\*\* Ethernet channel supports Open Protocol, ToolsNet, EtherNet/IP, Modbus TCP, PFCS, XML, and FTP Client.



## GEN IV ACE iBC-Z Controller for Uryu UBX-AF Transducerized Battery Oil Pulse Tools



Model*	System Port & Removable Memory	Lights (L) LED Display (D) Graph (G)	24v I/O Assignable 8 X 8"	Serial Port With Protocols	Backup & Restore (USB)	Ethernet** Two Ports
<b>Connectivity through embedded Zigbee access point</b>						
iBC4EGV(P-Z)(N-Z)(D-Z)(C-Z)(M-Z)	X	L/D/G	X	X	X	X

\* Field bus options: P = Profibus N = Profinet D = DeviceNet C = CC Link M = CC-Link IE Field Other Field bus options available upon request.  
\*\* Ethernet channel supports Open Protocol, ToolsNet, EtherNet/IP, Modbus TCP, PFCS, XML, and FTP Client.

# AcraDyne Gen IV ACE Controller Platform

## NETWORK CONNECTIVITY



## POKA-YOKE ERROR PROOFING

AcraDyne's Gen IV ACE Platform supports any third-party accessory to poka-yoke your process.

### FEATURES AND BENEFITS

- 24V I/O inputs support the outputs of the receiver units
- Connect click wrenches, crimpers, or any poka-yoked device to your network data collection and line controls with all of the Ethernet protocols and Field Buses offered in the ACE Platform



# AcraDyne Controller Software

## SOFTWARE

AcraDyne's software package is on-board every AcraDyne controller and is provided FREE of charge. This comprehensive, user-friendly program allows programming, analysis, and diagnostics.

The software is based on a standard web browser, allowing you to connect the AcraDyne controller with any computer, tablet, or smart device. Connect through Ethernet, USB, or wirelessly via a network connected to both devices.

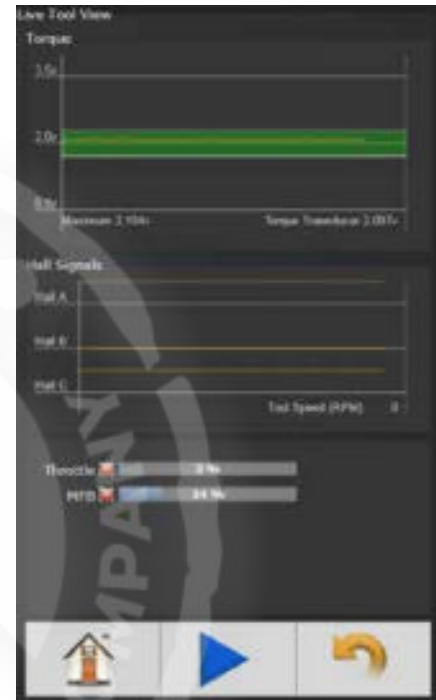
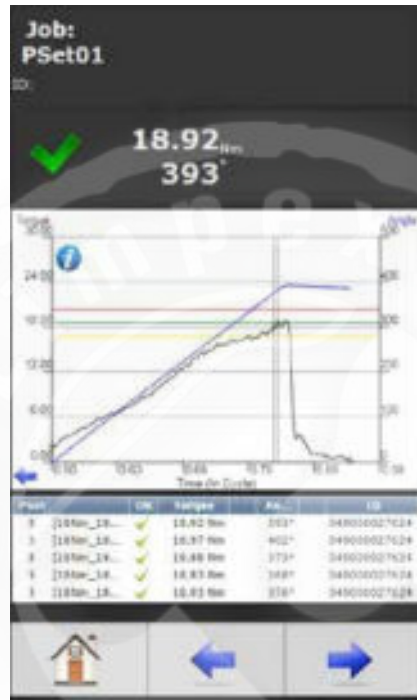
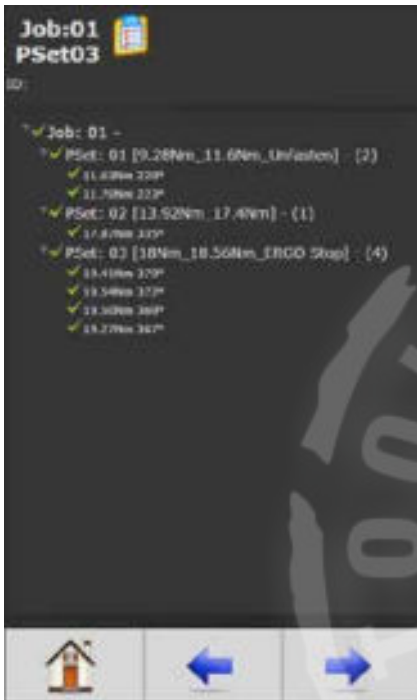

Adding and editing Parameter Sets (256) and Jobs (99) is easy and intuitive in the parameter set up function.

View curve results in real time or view stored results. As many as 20,000 curve results can be stored in memory.

Tool programming and diagnostics for repair, calibration and advanced troubleshooting.



Choose from several run screens that display easy to view, large screen indicators.

# Gen IV Smart Arm System With Process Visualization

## Gen IV Controller with On-Board Smart Arm Capability and Process Visualization

AcraDyne Gen IV Controller's smart arm capability provides an advanced error-proofing solution to ensure the quality of your fastening operation. The process requires no external PC or software – the capability is on-board every Gen IV controller.

### FEATURES AND BENEFITS

- Easy-to-follow visual guidance on the Gen IV controller graphical screen
- Easy setup – programming takes only minutes
- Once fastener locations are programmed into the Gen IV controller, the system can perform specific actions on specific fasteners
- No external PC or third-party software needed. Control the process using AcraDyne's Gen IV Controller and its integrated software, which is provided free of charge
- Low-cost solution vs. competitive offerings that require third-party PC-based control
- Modular – can be added at any time to an existing AcraDyne system using the Gen IV controller
- No guesswork! Powerful Gen IV data collection enables diagnostics and analysis
- Works with both continuous and discontinuous drive tools



The Gen IV controller provides easy-to-follow visual guidance directly on the graphical screen.

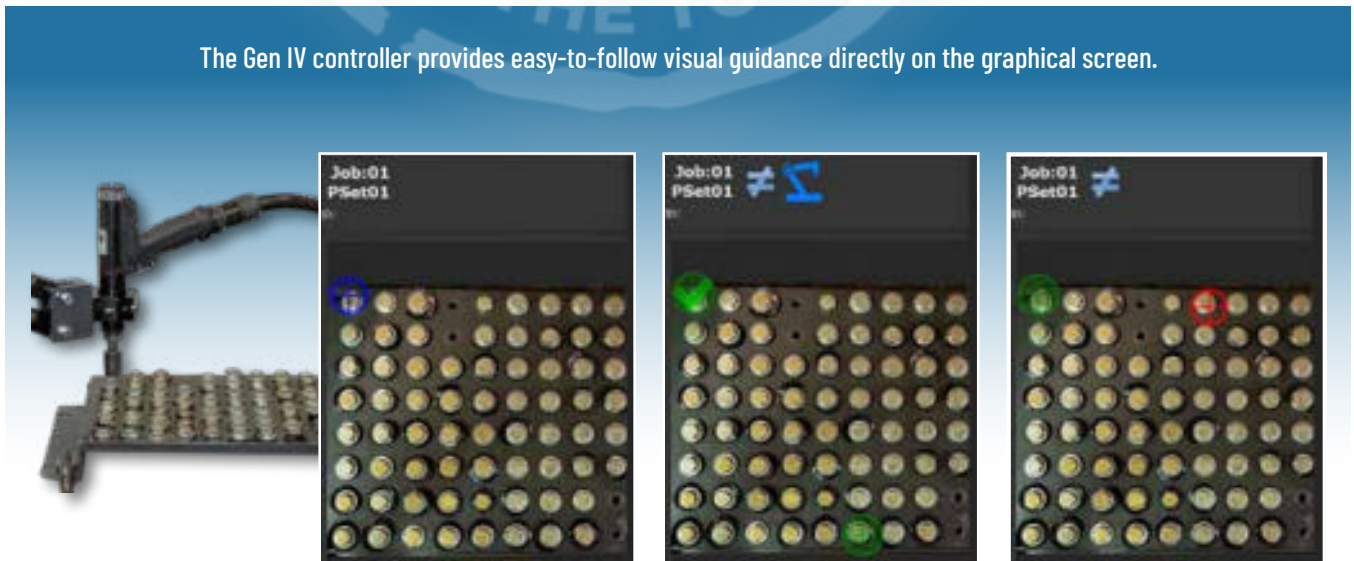

Tool in position over Bolt 1

Bolt 1 OK  
Direction to Bolt 2

Tool in wrong location

# Gen IV Smart Arm System With Process Visualization



## Gen IV Smart Arm System with Process Visualization

### Smart Arm Accessory:

- Requires no external PC or third-party software for operation
- Gen IV Controller Software integrates with plant manufacturing execution software or allows custom programming

Smart Arm guides operator in the specified torque pattern and counts fasteners required for correct assembly.

Encoders located at each joint of the arm.

### Gen IV Controller captures fastening-process data:

- Data captured and reported in real time with torque and graphing capabilities
- Curve results presented in real time or from stored results
- 20,000 curve results can be stored in memory
- Monitor, control, and report torque, angle, engineering units, fastener count, job/job sequence
- Multiple fastening strategies: 256 parameter sets with 20 stages
- Jobs capabilities - 99



Smart Arm Accessory

Gen IV Controller with Large 7" Touch Screen

Custom image of run screen with preprogrammed fastener locations/specifications. Updates in real time.

Tool operates only when it is at the correct specified fastener location.



# 1000 SERIES

## 1 – 22 Nm

- Superior size, speed, and duty cycle compared to competitors' tools
- Durable Nylon motor and handle housing
- Onboard lights and audible signal for operator feedback



### 1000 Series Pistol Tools

- Bottom, top, rear exit and push-to-start models available
- Standard Square Drive or extended Ergo Drive output available on all models
- 1/4" Quick Change output available on 3 – 14 Nm models
- Programmable Multi-Function Button: One single button facilitates several distinctly different tasks

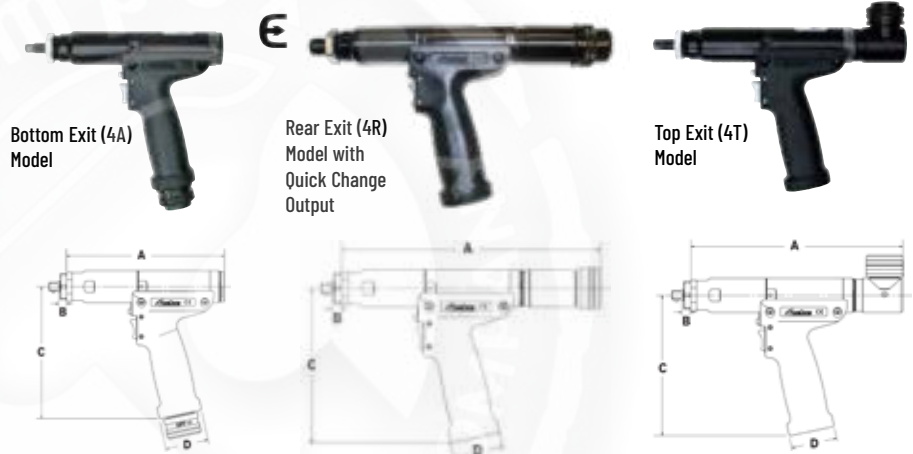

### 1000 Series Pistol Tools

Model	Max Torque		Torque Range		Free Speed RPM	Weight (-) Socket		Output Drive SQ DR	A		B		C		D	
	NM	FT-LB	NM	FT-LB		LB	KG		IN	MM	IN	MM	IN	MM	IN	MM
Pistol																
4A Models = Bottom Exit    4R Models = Rear Exit    4T Models = Top Exit																
(V) = Extended Ergo-Drive Output    (Q) = 1/4" Quick Change Output																
AEP4(A)(R)(T)12003B(V)(Q)	3	2.2	0.8 - 3	0.6 - 2.2	2,625	2.2	1.00	3/8"	A = 6.5 R = 9.3 T = 8.3	165.1 236 210.9	0.38	9.6	6.01	152.6	1.96	49.7
AEP4(A)(R)(T)12006B(V)(Q)	6	4.4	1.5 - 6	1.1 - 4.4	2,625	2.2	1.00	3/8"	A = 6.5 R = 9.3 T = 8.3	165.1 236 210.9	0.38	9.6	6.01	152.6	1.96	49.7
AEP4(A)(R)(T)12011B(V)(Q)	11	8.1	2.8 - 11	2 - 8.1	1,313	2.3	1.04	3/8"	A = 7.17 R = 10.34 T = 8.97	182.2 262.7 228	0.38	9.6	6.01	152.6	1.96	49.7
AEP4(A)(R)(T)12014B(V)(Q)	14	10	3.5 - 14	2.6 - 10	1,037	2.3	1.04	3/8"	A = 7.17 R = 10.34 T = 8.97	182.2 262.7 228	0.38	9.6	6.01	152.6	1.96	49.7
AEP4(A)(R)(T)12018BV	18	13	4.5 - 18	3.3 - 13	840	2.3	1.04	3/8"	A = 7.17 R = 10.34 T = 8.97	182.2 262.7 228	0.38	9.6	6.01	152.6	1.96	49.7
AEP4(A)(R)(T)12022BV	22	16	5.5 - 22	4.1 - 16	656	2.3	1.04	3/8"	A = 7.17 R = 10.34 T = 8.97	182.2 262.7 228	0.38	9.6	6.01	152.6	1.96	49.7
Pistol Push-to-Start																
AEP4T12003BL	3	2.2	0.8 - 3	0.6 - 2.2	2,625	2.2	1.00	3/8"	8.88	225.5	0.25	6.3	6.01	152.6	1.96	49.7
AEP4T12006BL	6	4.4	1.5 - 6	1.1 - 4.4	2,625	2.2	1.00	3/8"	8.88	225.5	0.25	6.3	6.01	152.6	1.96	49.7
AEP4T12011BL	11	8.1	2.8 - 11	2 - 8.1	1,313	2.3	1.04	3/8"	8.97	228	0.25	6.3	6.01	152.6	1.96	49.7
AEP4T12014BL	14	10	3.5 - 14	2.6 - 10	1,037	2.3	1.04	3/8"	8.97	228	0.25	6.3	6.01	152.6	1.96	49.7

\* E logo indicates where ERGO-DRIVE sockets/extensions benefit tool operation.

## 1000 Series Angle Tools

- Compact, durable head houses a precision right-angle gearset that fits into the tightest spaces
- Integrated transducer for accurate delivery or monitoring of Torque and Angle
- Lightweight materials and uniform body diameter provide a comfortable grip
- Ergonomically placed start lever for ease of operation
- Available in regular or flush socket options

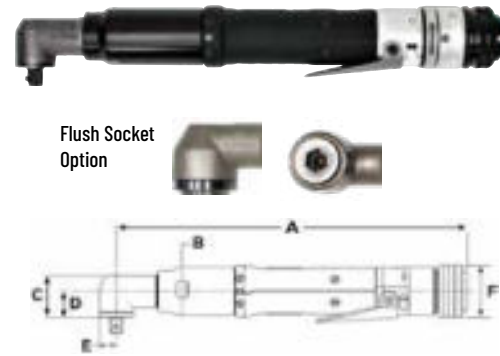

### 1000 Series Angle Tools

Model	Max Torque		Torque Range		Free Speed RPM	Weight (-)Socket		Output Drive SO DR	A		B		C		D		E		F	
	NM	FT-LB	NM	FT-LB		LB	KG		IN	MM	IN	MM	IN	MM	IN	MM	IN	MM	IN	MM
Angle Add "F" to Part Numbers for Flush Socket																				
AEN4C12004B	4	3	1 - 4	0.7 - 3	3,111	2.0	0.91	3/8"	11.04	280.4	1.47	37.3	1.29	32.8	0.82	20.9	.52	13.1	1.56	39.6
AEN4C12009B	9	6.6	2.3 - 9	1.7 - 6.6	1,750	2.2	1.00	3/8"	11.01	279.6	1.47	37.3	1.29	32.8	0.82	20.9	.52	13.1	1.56	39.6
AEN4C12014B	14	10	3.5 - 14	2.6 - 10	875	2.2	1.00	3/8"	11.65	295.9	1.47	37.3	1.29	32.8	0.82	20.9	.52	13.1	1.56	39.6
AEN4C12018B	18	13	4.5 - 18	3.3 - 13	691	2.2	1.00	3/8"	11.65	295.9	1.47	37.3	1.29	32.8	0.82	20.9	.52	13.1	1.56	39.6
AEN4C12022B	22	16	5.5 - 22	4.1 - 16	560	2.2	1.00	3/8"	11.65	295.9	1.47	37.3	1.29	32.8	0.82	20.9	.52	13.1	1.56	39.6

## 1000 Series Inline Tools

- Square drive or Ergo drive available on all inline models
- Quick change output available on 3 - 14 Nm inline and push-to-start models
- User modifiable reaction bar included with in-line tools for use in handheld applications



### 1000 Series Inline Tools

Model	Max Torque		Torque Range		Free Speed RPM	Weight (-)Socket		Output Drive SO DR	A		B		C		D		E	
	NM	FT-LB	NM	FT-LB		LB	KG		IN	MM	IN	MM	IN	MM	IN	MM	IN	MM
Inline V = Extended Ergo-Drive Output Q = 1/4" Quick Change Output																		
AES4A12003B(V)(Q)	3	2.2	0.8 - 3	0.6 - 2.2	2,625	2.0	0.91	3/8"	11	279.4	1.47	37.3	7.43	188.6	1.56	39.6	1.31	33.4
AES4A12006B(V)(Q)	6	4.4	1.5 - 6	1.1 - 4.4	2,625	2.0	0.91	3/8"	11	279.4	1.47	37.3	7.43	188.6	1.56	39.6	1.31	33.4
AES4A12011B(V)(Q)	11	8.1	2.8 - 11	2 - 8.1	1,313	2.2	1.00	3/8"	11	279.4	1.47	37.3	7.43	188.6	1.56	39.6	1.31	33.4
AES4A12014B(V)(Q)	14	10	3.5 - 14	2.6 - 10	1,037	2.2	1.00	3/8"	11	279.4	1.56	39.6	7.43	188.6	1.56	39.6	1.31	33.4
AES4A12018BV	18	13	4.5 - 18	3.3 - 13	840	2.2	1.00	3/8"	11	279.4	1.47	37.3	7.43	188.6	1.56	39.6	1.31	33.4
AES4A12022BV	22	16	5.5 - 22	4.1 - 16	656	2.2	1.00	3/8"	11	279.4	1.47	37.3	7.43	188.6	1.56	39.6	1.31	33.4
Inline Push-to-Start (Q) = 1/4" Quick Change Output																		
AEL4A12003B(Q)	3	2.2	0.8 - 3	0.6 - 2.2	2,625	2.0	0.91	3/8"	10.69	271.6	1.56	39.6	7.38	187.4	0.21	5.3	1.56	39.6
AEL4A12006B(Q)	6	4.4	1.5 - 6	1.1 - 4.4	2,625	2.0	0.91	3/8"	10.69	271.6	1.56	39.6	7.38	187.4	0.21	5.3	1.56	39.6
AEL4A12011B(Q)	11	8.1	2.8 - 11	2 - 8.1	1,313	2.2	1.00	3/8"	11.26	286.1	1.56	39.6	7.38	187.4	0.21	5.3	1.56	39.6
AEL4A12014B(Q)	14	10	3.5 - 14	2.6 - 10	1,037	2.2	1.00	3/8"	11.26	286.1	1.56	39.6	7.38	187.4	0.21	5.3	1.56	39.6
AEL4A12018B	18	13	4.5 - 18	3.3 - 13	840	2.2	1.00	3/8"	11.26	286.1	1.56	39.6	7.38	187.4	0.21	5.3	1.56	39.6
AEL4A12022B	22	16	5.5 - 22	4.1 - 16	656	2.2	1.00	3/8"	11.26	286.1	1.56	39.6	7.38	187.4	0.21	5.3	1.56	39.6

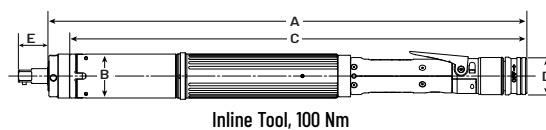

\* E logo indicates where ERGO-DRIVE sockets/extensions benefit tool operation.

### 1000 Series Tubenut Tools

- Durable tubenut head design
- Simple, one-touch back to open operation for maximum productivity
- Innovative Sensor Technology: Transducer senses resistance in the initial 90 degrees of rotation and returns to open upon resistance encountered

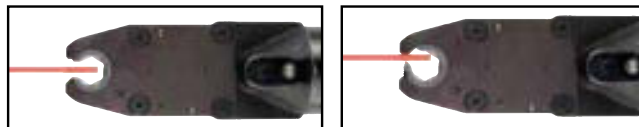

INNOVATIVE SAFETY SENSOR TECHNOLOGY: Tool returns to open upon resistance encountered in initial 90° of rotation.

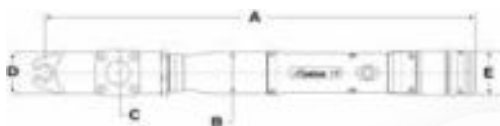

### 1000 Series Tubenut Tools

1000 Series Tubenut	Max Torque		Torque Range		Free Speed RPM	Weight (-) Socket		Output Drive		A		B		C		D		E	
	NM	FT-LB	NM	FT-LB		LB	KG	IN	MM	IN	MM	IN	MM	IN	MM	IN	MM	IN	MM
Tubenut Wide variety of socket sizes available																			
AET4AA12018B	14	13	3.6 - 14	2.7 - 11	516	3.1	1.41	1/4 - 7/16	7 - 12	15.4	391.5	1.47	37.3	1.57	40	1.46	37	1.56	39.6
AET4AB12025B	20	18	5 - 20	3.7 - 15	387	3.1	1.41	3/8 - 5/8	10 - 17	15.9	404.9	1.47	37.3	1.57	40	1.56	39.5	1.56	39.6
AET4A12025B-KD	25	18	5 - 25	3.7 - 18	387	3.1	1.41	3/8 - 5/8	10 - 17	15.9	403.2	1.47	37.3	1.64	41.6	1.64	41.6	1.56	39.6
AET4A12030B-KD	30	22	6 - 30	4.4 - 22	285	3.1	1.41	3/8 - 5/8	10 - 17	15.9	403.2	1.47	37.3	1.64	41.6	1.64	41.6	1.56	39.6

### 1000 Series Fixtured Tools

- Rear & bottom exit available
- Standard Square Drive, Extended Ergo Drive, or 1/4" Quick Change outputs available in most models
- Integrated Sliding Spindles offered in varying lengths of travel to suit specific application needs

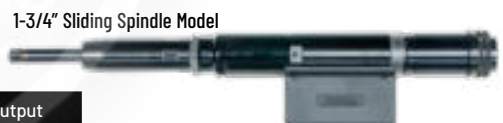

### 1000 Series Fixtured Tools

Model	Max Torque		Torque Range		Free Speed RPM	Weight (-) Socket		Output Drive SQ DR
	NM	FT-LB	NM	FT-LB		LB	KG	
Fixtured 4A models = 1/2" sliding spindle 4C Models = 1-3/4" Sliding Spindle 4X Models = Fixed 3/8" Sq. Dr. (B) = Bottom Exit Cable (Q) = 1/4" Quick Change Output								
AEF4(A)(C)(X)12003B(B)(Q)	3	2.2	0.8 - 3	0.6 - 2.2	2,625	2.0	0.91	3/8"
AEF4(A)(C)(X)12006B(B)(Q)	6	4.4	1.5 - 6	1.1 - 4.4	2,625	2.0	0.91	3/8"
AEF4(A)(C)(X)12011B(B)(Q)	11	8.1	2.8 - 11	2 - 8.1	1,313	2.2	1.00	3/8"
AEF4(A)(C)(X)12014B(B)(Q)	14	10	3.5 - 14	2.6 - 10	1,037	2.2	1.00	3/8"
AEF4(A)(C)(X)12018B(B)	18	13	4.5 - 18	3.3 - 13	840	2.2	1.00	3/8"
AEF4(A)(C)(X)12022B(B)	22	16	5.5 - 22	4.1 - 16	656	2.2	1.00	3/8"



AEF4A 1/2" Sliding Spindle Model

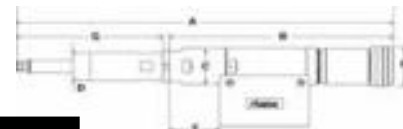

AEF4C 1-3/4" Sliding Spindle Model

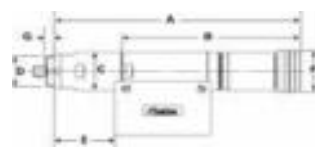

AEF4X Fixed 3/8" Sq. Dr. Model

### 1000 Series Fixtured Tool Dimensions

Fixtured	A		B		C		D		E		F		G	
	IN	MM	IN	MM	IN	MM	IN	MM	IN	MM	IN	MM	IN	MM
AEF4A12003B / AEF4A12006B	11.57	294	9.14	231.1	1.47	37.3	1.12	28.6	2.05	52.2	1.59	40.4	2.18	55.5
AEF4A12011B / AEF4A12014B / AEF4A12018B / AEF4A12022B	12.20	309.8	9.14	231.1	1.47	37.3	1.12	28.6	2.72	69.2	1.59	40.4	2.18	55.5
AEF4C12003B / AEF4C12006B	15.36	390.3	9.14	231.1	1.47	37.3	1.12	28.6	2.05	52.2	1.59	40.4	5.98	151.8
AEF4C12011B / AEF4C12014B / AEF4C12018B / AEF4C12022B	15.99	406.1	9.14	231.1	1.47	37.3	1.12	28.6	2.72	69.2	1.59	40.4	5.98	151.8
AEF4X12003B / AEF4X12006B	9.35	237.5	6.82	173.2	1.47	37.3	1.31	33.4	2.06	52.2	1.59	40.4	0.38	9.7
AEF4X12011B / AEF4X12014B / AEF4X12018B / AEF4X12022B	10.02	254.4	6.82	173.2	1.47	37.3	1.31	33.4	2.72	69.1	1.59	40.4	0.38	9.7

\* E logo indicates where ERGO-DRIVE sockets/extensions benefit tool operation.

# 2000 SERIES

3 – 55 Nm

- Superior size, speed, and duty cycle compared to competitors' tools
- Durable Nylon motor and handle housing
- Aluminum motor and gear housing
- Onboard lights and audible signal for operator feedback



## 2000 Series Pistol Tools

- Bottom, top, rear exit and push-to-start model available
- Standard Square Drive or extended Ergo Drive output available on all models
- Programmable Multi-Function Button: One single button facilitates several distinctly different tasks

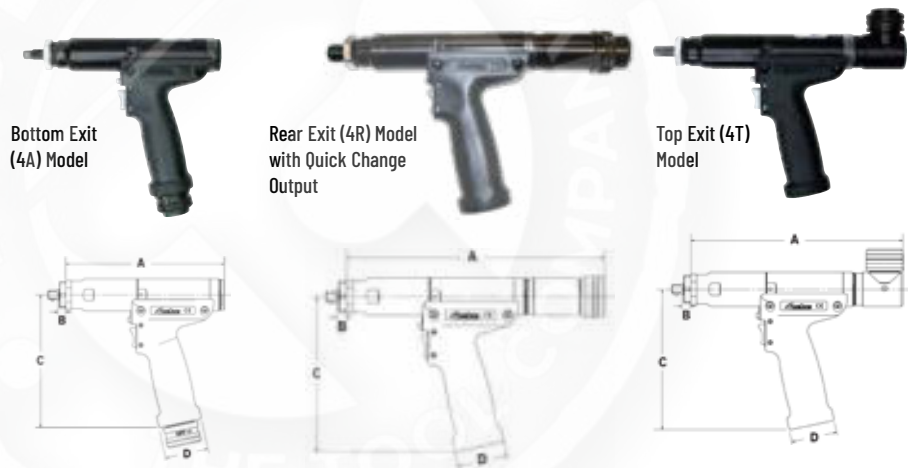

## 2000 Series Pistol Tools

Model	Max Torque		Torque Range		Free Speed Rpm	Weight (-) Socket		Output Sq Dr	(A)		(B)		(C)		(D)	
	Nm	Ft-Lb	Nm	Ft-Lb		Lb	Kg		In	Mm	In	Mm	In	Mm	In	Mm
Pistol Tools	4A Models = Bottom Exit		4R Models = Rear Exit		4T Models = Top Exit		(V) = Extended Ergo-Drive Output									
AEP4(A)(R)(T)22020B(V)	20	14	5 - 20	3.7 - 14	1,313	2.4	1.09	3/8"	A = 7.82 R = 10.65 T = 9.71	198.7 270.6 246.5	0.38 9.7	A = 6.94 R = 6.01 T = 6.01	176.2 152.6 152.6	1.96	49.7	
AEP4(A)(R)(T)22025B(V)	25	18	6.3 - 25	4.6 - 18	1,037	2.4	1.09	3/8"	A = 7.82 R = 10.65 T = 9.71	198.7 270.6 246.5	0.38 9.7	A = 6.94 R = 6.01 T = 6.01	176.2 152.6 152.6	1.96	49.7	
AEP4(A)(R)(T)22030B(V)	30	22	7.5 - 30	5.5 - 22	840	2.4	1.09	3/8"	A = 7.82 R = 10.65 T = 9.71	198.7 270.6 246.5	0.38 9.7	A = 6.94 R = 6.01 T = 6.01	176.2 152.6 152.6	1.96	49.7	
AEP4(A)(R)(T)22035B(V)	35	25	8.8 - 35	6.5 - 25	747	2.4	1.09	3/8"	A = 7.82 R = 10.65 T = 9.71	198.7 270.6 246.5	0.38 9.7	A = 6.94 R = 6.01 T = 6.01	176.2 152.6 152.6	1.96	49.7	
AEP4(A)(R)(T)22040B(V)	40	29	10 - 40	7.4 - 29	656	2.4	1.09	3/8"	A = 7.82 R = 10.65 T = 9.71	198.7 270.6 246.5	0.38 9.7	A = 6.94 R = 6.01 T = 6.01	176.2 152.6 152.6	1.96	49.7	

\*Ergo logo indicates where ERGO-DRIVE sockets/extensions benefit tool operation.

## 2000 Series Angle and Inline Tools

### Gen IV Series Angle and Inline Nutrunners

Smart, Rugged, and Cost-Effective: The New Leader in Accurate Fastening



#### FEATURES AND BENEFITS

- New robust design is lighter, slimmer, and more ergonomic than previous Gen III nutrunners
- One of the lowest total cost of ownership in the industry
- Ergonomic updated trigger design integrates trigger to tool body, requiring a shorter activation stroke
- Indexable head optimizes trigger position
- Smooth-grip handle
- Short length means easier tool positioning
- Backward compatible with all Gen III and Gen IV AcraDyne controllers

### 2000 Series Angle & Inline Tools

Model	Torque Range		Free Speed RPM	Weight (-)Socket		Output SQ DR	(A)		(B)		(C)		(D)		(E)		(F)		
	NM	FT-LB		LB	KG		MM	IN	MM	IN	MM	IN	MM	IN	MM	IN	MM	IN	
Angle Tools		(V)= Extended Ergo-Drive Output			(DL)= Dual Lever														
AEN4C22014C	3.5 - 14	2.6 - 10.3	1750	2.7	1.2	3/8	397	15.6	32	1.3	59.4	2.3	43.3	1.7	160	6.3	20.9	0.8	
AEN4C22024C	6 - 24	4.4 - 17.7	875	2.7	1.2	3/8	397	15.6	32	1.3	59.4	2.3	43.3	1.7	160	6.3	20.9	0.8	
AEN4F22029C	7.3 - 29	5.4 - 21.4	788	3.2	1.5	3/8	419	16.5	33.4	1.3	79.8	3.1	43.3	1.7	160	6.3	29.4	1.16	
AEN4F22036C	9 - 36	6.6 - 26.6	622	3.2	1.5	3/8	419	16.5	33.4	1.3	79.8	3.1	43.3	1.7	160	6.3	29.4	1.16	
AEN4F22043C(VDL)	10.8 - 43	8 - 31.7	504	3.2	1.5	3/8	419	16.5	33.4	1.3	79.8	3.1	43.3	1.7	160	6.3	29.4	1.16	
AEN4F22055C(V)	13.8 - 55	10.2 - 40.6	394	3.2	1.5	3/8	419	16.5	33.4	1.3	79.8	3.1	43.3	1.7	160	6.3	29.4	1.16	
Inline Tools (Includes Reaction Bar and Fixture Nut)																			
AES4A22020CV	5 - 20	3.7 - 14.8	1,313	2.8	1.3	3/8	401	15.8	95.9	3.8	109.5	4.3	43.3	1.7	160	6.3	381	15	
AES4A22025CV	6.3 - 25	4.6 - 18.4	1,037	2.8	1.3	3/8	401	15.8	95.9	3.8	109.5	4.3	43.3	1.7	160	6.3	381	15	
AES4A22030CV	7.5 - 30	5.5 - 22.1	840	2.8	1.3	3/8	401	15.8	95.9	3.8	109.5	4.3	43.3	1.7	160	6.3	381	15	
AES4A22035CV	8.8 - 35	6.5 - 25.8	747	2.8	1.3	3/8	401	15.8	95.9	3.8	109.5	4.3	43.3	1.7	160	6.3	381	15	
AES4A22040CV	10 - 40	7.4 - 29.5	656	2.8	1.3	3/8	401	15.8	95.9	3.8	109.5	4.3	43.3	1.7	160	6.3	381	15	

Angle Tool Dimensions

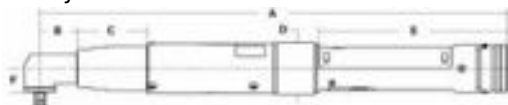

Inline Tool Dimensions



## 2000 Series Tubenut Tools

- Durable tubenut head design
- Simple, one-touch back to open operation for maximum productivity
- Innovative Sensor Technology: Transducer senses resistance in the initial 90 degrees of rotation and returns to open upon resistance encountered

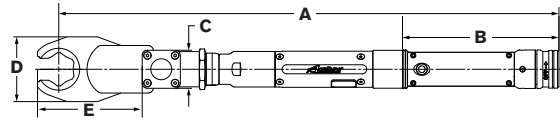

### 2000 Series Tubenut Tools

1000 Series Tubenut	Torque Range		Free Speed RPM	Weight (-) Socket		Output Drive		A		B		C		D		E	
	NM	FT-LB		LB	KG	IN	MM	IN	MM	IN	MM	IN	MM	IN	MM	IN	MM
Wide variety of socket sizes available (DL) = Dual Lever																	
AET4AA22016C(DL)	4 - 16	3 - 11.8	1,828	4.1	1.86	1/4 - 7/16	7 - 12	19.1	484.3	6.5	164.4	1.6	40	1.5	37	2.2	56
AET4AB22021C(DL)	5.3 - 21	4 - 15.5	1,371	5.0	2.27	3/8 - 5/8	10 - 17	19.6	498.7	6.5	164.4	1.6	40	1.6	40	2.9	74
AET4AC22028C(DL)	7 - 28	5 - 20.7	1,020	5.5	2.49	1/2 - 7/8	13 - 24	20	508.4	6.5	164.4	1.6	40	2.2	56	3.5	88
AET4AD22038CDL	9.5 - 38	7 - 28	756	6.6	2.99	5/8 - 1-3/16	17 - 32	20.7	525.9	6.5	164.4	1.6	40	2.7	68	4.3	110

## 2000 Series Hold and Drive Tools

- 1" & 2" travel models available
- Sockets and holders are custom

1" Travel (C-1) Model

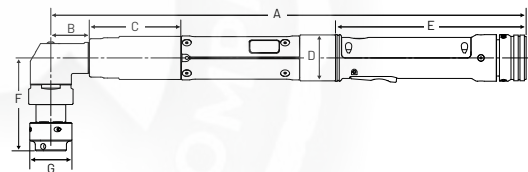

### 2000 Series Hold and Drive Tools

Model*	Max Torque		Torque Range		Free Speed RPM	Weight (LB)	Min Socket Max Socket	(A)		(B)		(C)		(D)		(E)		(F)		(G)	
	NM	FT-LB	NM	FT-LB				IN	MM	IN	MM	IN	MM	IN	MM	IN	MM	IN	MM	IN	MM
Hold & Drive (-1) = 1" Travel (-2) = 2" Travel																					
AEH4F22036C(-1)	36	27	7 - 36	5 - 27	871	-1 = 1.5 kg / 3.4 lb	9/16 (14 mm) 13/16 (21 mm)	16.2	412	1.3	33.4	3.2	80	1.6	40	6.5	165	-1 = 3.2	80.6	1.4	36.5
AEH4F22043C(-1)(-2)	43	32	9 - 43	7 - 32	705	-1 = 1.5 kg / 3.4 lb -2 = 1.7 kg / 3.7 lb	9/16 (14 mm) 13/16 (21 mm)	16.2	412	1.3	33.4	3.2	80	1.6	40	6.5	165	-1 = 3.2 -2 = 4.2	-1 = 80.6 -2 = 106	1.4	36.5
AEH4F22055C(-1)	55	41	11 - 55	8 - 41	551	-1 = 1.5 kg / 3.4 lb	9/16 (14 mm) 13/16 (21 mm)	16.2	412	1.3	33.4	3.2	80	1.6	40	6.5	165	-1 = 3.2	80.6	1.4	36.5

## 2000 Series Mid-Exit Tools

### FEATURES AND BENEFITS

- Length
  - Reduced tool length due to cable exiting in front of grip surface
- Ergonomics
  - Reduced torque reaction compared to pistol-style tools
  - The inline handle, coupled with the ergonomic hand positioning, allows for increased leverage and decreased strain on the wrist
- Cable management
  - If used with a spring balancer, the tool hangs naturally near its center of gravity, the cable is controlled by the balancer
  - Front positioning of cable provides for easy cable management

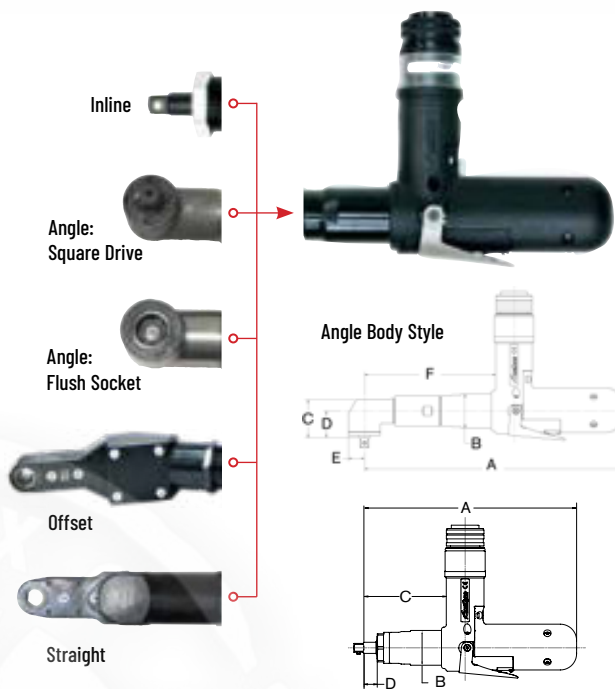

### 2000 Series Mid-Exit Cable Tools

Model	Max Torque		Torque Range		Free Speed RPM	Weight (-)Socket		Output SQ. DR.	A		B		C		D		E		F	
	NM	FT-LB	NM	FT-LB		LB	KG		IN	MM	IN	MM	IN	MM	IN	MM	IN	MM	IN	MM
Mid-Exit Models: Angle Body Style Add "F" to Part Numbers for Flush Socket																				
AEN4C22015BM(F)	15	11	3.75 - 15	2.77 - 11	700	2.6	1.18	3/8"	9.02	229.1	1.47	37.3	1.29	32.8	.82	20.9	.52	13.1	3.51	89.3
AEN4F22030BM(F)	30	22	7.5 - 30	5.53 - 22	675	3.3	1.50	3/8"	11.24	285.6	1.47	37.3	1.66	42.1	1.17	29.7	.70	17.8	5.73	145.6
AEN4F22037BM(F)	37	29	9.25 - 37	6.82 - 29	533	3.3	1.50	3/8"	11.24	285.6	1.47	37.3	1.66	42.1	1.17	29.7	.70	17.8	5.73	145.6
AEN4F22044BM(F)	44	32	11 - 40	8.11 - 29	432	3.3	1.50	3/8"	11.24	285.6	1.47	37.3	1.66	42.1	1.17	29.7	.70	17.8	5.73	145.6
Mid-Exit Models: Inline, Straight, and Offset Body Style																				
AES4A22020BVM	20	15	5 - 20	3.7 - 15	1050	2.4	1.09	3/8"	9.0	228.5	1.47	37.3	3.49	88.6	.56	14.2	—	—	—	—
AES4A22025BVM	25	18	6.3 - 25	4.6 - 18	830	2.4	1.09	3/8"	9.0	228.5	1.47	37.3	3.49	88.6	.56	14.2	—	—	—	—
AES4A22030BVM	30	22	7.5 - 30	5.5 - 22	672	2.4	1.09	3/8"	9.0	228.5	1.47	37.3	3.49	88.6	.56	14.2	—	—	—	—
AES4A22040BVM	40	30	10 - 40	7.4 - 30	525	2.4	1.09	3/8"	9.0	228.5	1.47	37.3	3.49	88.6	.56	14.2	—	—	—	—

Introducing AcraDyne's Discontinuous Drive Tool

**AcraDrive**

**ONE TOOL**

**TWO WAYS TO DRIVE**

Providing amazing flexibility in one tool, the AcraDyne Discontinuous Drive Nutrunner adds choice, speed, accuracy, and virtually reaction-free tightening to the user-friendly GEN IV Ecosystem



**ONE TOOL, THREE TIGHTENING STRATEGIES**

- Continuous Mode
  - Tool can be programmed to run in Continuous Mode like traditional DC nutrunners (within ergonomically acceptable limits)
- Discontinuous Mode
  - Virtually reaction-free performance with great accuracy and controllability
- Continuous Mode & Discontinuous Mode
  - Unique capability in a single tool delivers torque to the fastener in both Continuous and Discontinuous modes when programmed in a multistage parameter

**DISCONTINUOUS DRIVE ADVANTAGES**

- High torque accuracy
- High tool speeds
- Minimal torque reaction as well as low vibration & noise
- One-handed operation
- Durable motor and gearing for long lifespan between preventative maintenance



DESIGNED + MADE IN THE USA





Offering the greatest flexibility in one tool. The AcraDrive Discontinuous nutrunner offers three modes that are programmable in the Gen IV Controller. The ability to operate in Continuous Mode, Discontinuous Mode, or Continuous & Discontinuous Mode with one tool means ultimate cost savings with multiple features. No more need to sacrifice ergonomics for reduced cost of ownership, or forfeit high tool speeds in order to achieve traceable data.



**FEATURES AND BENEFITS**

**Speed & Accuracy**

- Combines fast tool speeds with Discontinuous drive and advanced data tracing
- Torque is measured by an industry standard Strain Gauge traceable transducer

**Low Maintenance**

- Precision Gearing tested to greater than 500,000 cycle reliability
- Sealed Brushless Optimized Motors with zero maintenance requirements

**Safe & Ergonomic Operation**

- Optimal balance for less operator fatigue
- Minimal Torque Reaction Properties in Discontinuous Mode
- Proprietary Motor Control Algorithm for Optimizing to Application Demands

**Flexibility & Cost Savings**

- Connects to the industry's most intuitive control platform – AcraDyne's iEC Gen IV Controller
- One tool capable of Continuous and Discontinuous drive means that one tool can cover more applications
- No software add-ons required and no-cost updates available at [www.aimco-global.com](http://www.aimco-global.com)



**2000 Series Discontinuous Drive Tools**

Model	Torque Range		Max Speed RPM	Joints		Length		Weight		Output Sq. Drive
	NM	FT-LB		Hard	Medium	IN	MM	LB	KG	
AEP4P22030AV	18 - 30	13.3 - 22	1,579	20 - 80°	80 - 150°	10.6	270	4.05	1.84	3/8"
AEP4P22050AV	28 - 50	20.7 - 37	1,579	20 - 80°	80 - 150°	10.7	273	4.05	1.84	1/2"

# 3000 SERIES

10 – 600 Nm

- Superior size, speed, and duty cycle compared to competitors' tools
- Aluminum gear and motor housing
- Onboard lights and audible signal for operator feedback



## 3000 Series Angle Tools

- Provides the perfect solution for space-limited applications
- Compact, durable head houses a precision right-angle gearset that fits into the tightest spaces
- Integrated transducer for accurate delivery or monitoring of Torque and Angle
- Lightweight materials and uniform body diameter provide a comfortable grip
- Ergonomically placed start lever for ease of operation
- Available in regular or flush socket options
- Dual-Lever available on 60 – 375 Nm models

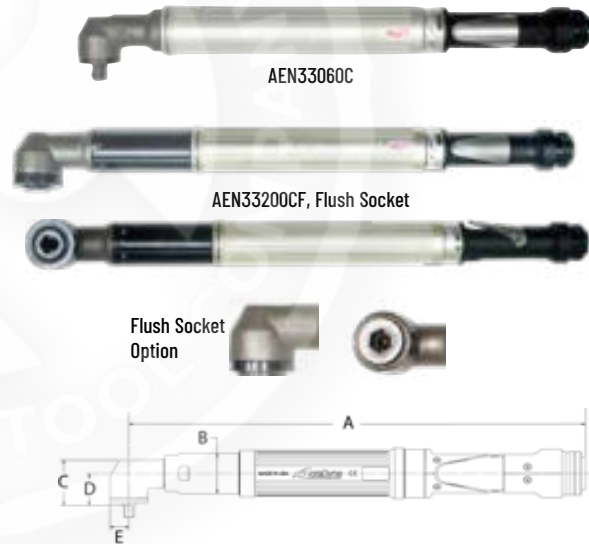

## 3000 Series Angle Tools

Model	Max Torque		Torque Range		Free Speed RPM	Weight (-) Socket		Output SQ. DR	(A)		(B)		(C)		(D)		(E)	
	NM	FT-LB	NM	FT-LB		LB	KG		IN	MM	IN	MM	IN	MM	IN	MM	IN	MM
3000 Series			Add "F" to Part Numbers for Flush Socket			DL = Dual Lever			(V) = Extended Ergo-Drive Output			W = Wobble Output Spindle						
AEN33060C(F)(DL)	60	44	12 - 60	9 - 44	845	6.6	2.99	1/2.	19.14	486.14	1.85	47	1.91	48.36	1.38	35.2	.83	21
AEN33090C(F)(DL)(V)(W)	90	66	18 - 90	13 - 66	568	6.6	2.99	1/2.	19.14	486.14	1.85	47	1.91	48.36	1.38	35.2	.83	21
AEN33120C(F)(DL)	120	89	24 - 120	18 - 88	442	9.3	4.22	1/2	21.22	539	1.85	47	2.78	71	2.08	53	1.05	27
AEN33200C(F)(DL)	200	148	40 - 200	29 - 147	245	9.4	4.26	3/4	23.43	595	1.85	47	2.54	65	1.84	47	1.05	27
AEN33210C(F)(DL)	210	155	50 - 210	37 - 155	234	10.0	4.54	3/4	23.8	604.5	1.85	47	2.97	75	2.04	52	1.25	32
AEN33300C(F)(DL)	300	221	60 - 300	42 - 221	151	10.0	4.54	3/4	23.72	602	1.85	47	2.97	75	2.04	52	1.25	32
AEN33375C(F)(DL)	375	277	75 - 375	55 - 276	151	10.0	4.54	3/4	23.72	602	1.85	47	2.97	75	2.04	52	1.25	32

### 3000 Series Inline Tools

- Compact and durable, AcraDyne 3000 Series inline nutrunners are the ideal choice for fixtured fastening applications
- A uniform body diameter and a hex-shaped mounting point allow for simple installation into fixtured plates
- User modifiable reaction bar included with in-line tools for use in handheld applications
- Standard Square Drive or extended Ergo Drive output available on all models

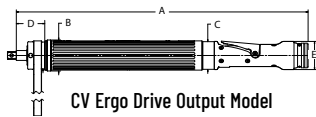

### 3000 Series Inline Tools

Model	Max Torque		Torque Range		Free Speed RPM	Weight (-) Socket		Output SQ. DR	(A)		(B)		(C)		(D)		(E)	
	NM	FT-LB	NM	FT-LB		LB	KG		IN	MM	IN	MM	IN	MM	IN	MM	IN	MM
3000 Series (V) = Extended Ergo-Drive Output -2 = 2" sliding spindle																		
AES33040C(V)(-2)	40	30	8 - 40	5.9 - 30	1,314	6.4	2.90	1/2"	V = 18.46 -2 = 23.89	469 606.8	1.96	49.8	V = 1.75 -2 = 1.85	44.5 47	V = 1.8 -2 = 4.3	45.7 109.5	1.78	45.2
AES33060C(V)(-2)	60	44	12 - 60	8.9 - 44	883	6.4	2.90	1/2"	V = 18.46 -2 = 23.89	469 606.8	1.96	49.8	V = 1.75 -2 = 1.85	44.5 47	V = 1.8 -2 = 4.3	45.7 109.5	1.78	45.2
AES33100C(V)(-2)	100	74	20 - 100	15 - 74	489	8.1	3.67	1/2"	V = 22.78 -2 = 27.71	578.6 703.8	1.96	49.8	V = 1.75 -2 = 1.85	44.5 47	V = 6.11 -2 = 3.96	155.3 100.5	1.78	45.2
AES33150C(V)(-2)	150	111	30 - 150	22 - 111	329	8.1	3.67	1/2"	V = 22.78 -2 = 27.71	578.6 703.8	1.96	49.8	V = 1.75 -2 = 1.85	44.5 47	V = 6.11 -2 = 3.96	155.3 100.5	1.78	45.2
AES33230C(V)(-2)	185	137	46 - 185	34 - 137	221	8.1	3.67	1/2"	V = 22.78 -2 = 27.71	578.6 703.8	1.96	49.8	V = 1.75 -2 = 1.85	44.5 47	V = 6.11 -2 = 3.96	155.3 100.5	1.78	45.2
AES33400C	400	295	80 - 400	59 - 295	122	13.0*	5.90*	3/4"			2.64	67.1	1.85	47	1.19	30.12	1.78	45.2
AES33600C	600	443	120 - 600	89 - 443	82	13.0*	5.90*	3/4"			2.64	67.1	1.85	47	1.19	30.12	1.78	45.2

\* Includes reaction bar and fixture nut

### 3000 Series Hold and Drive Tools

- 1" & 2" travel models available
- Sockets and holders are custom



1" Travel (C-1) Model

2" Travel (C-2) Model

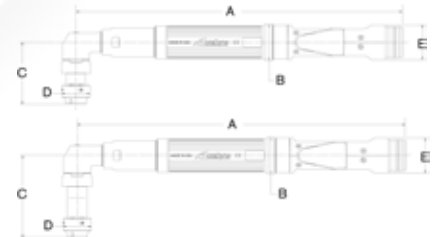

### 3000 Series Hold and Drive Tools

Model*	Max Torque		Torque Range		Free Speed RPM	Weight (LB)	Min Socket Max Socket	(A)		(B)		(C)		(D)		(E)	
	NM	FT-LB	NM	FT-LB				IN	MM	IN	MM	IN	MM	IN	MM	IN	MM
Hold & Drive (-1) = 1" Travel (-2) = 2" Travel																	
AEH33060C(-1)(-2)	60	44	12 - 60	9 - 44	845	-1 = 7.3 -2 = 7.5	9/16 (14 mm) 1-1/4 (32 mm)	19.1	485.1	1.85	47	-1 = 3.36 -2 = 4.37	85.3 111.1	1.88	47.6	1.78	45.2
AEH33090C(-1)(-2)	90	66	18 - 90	13 - 66	568	-1 = 7.3 -2 = 7.6	9/16 (14 mm) 1-1/4 (32 mm)	16.79	426.5	1.85	47	-1 = 3.36 -2 = 4.37	85.3 111.1	1.88	47.6	1.78	45.2
AEH33120C(-1)(-2)	120	89	24 - 120	18 - 89	442	-1 = 10.0 -2 = 10.3	5/8 (15 mm) 1-1/4 (32 mm)	21.22	539.1	1.85	47	-1 = 4.09 -2 = 5.09	103.8 129.2	2.25	57.2	1.78	45.2

\* E logo indicates where ERGO-DRIVE sockets/extensions benefit tool operation.

# 5000 SERIES

## 20 – 635 Nm

- Superior size, speed, and duty cycle compared to competitors' tools
- High duty cycle
- Durable Nylon motor and handle housing
- Onboard lights and audible signal for operator feedback



### 5000 Series Pistol Tools

- Bottom and top exit models, as well as push-to-start models available
- Ergo drive available on 75 – 170 Nm models
- Programmable Multi-Function Button: One single button facilitates several distinctly different tasks

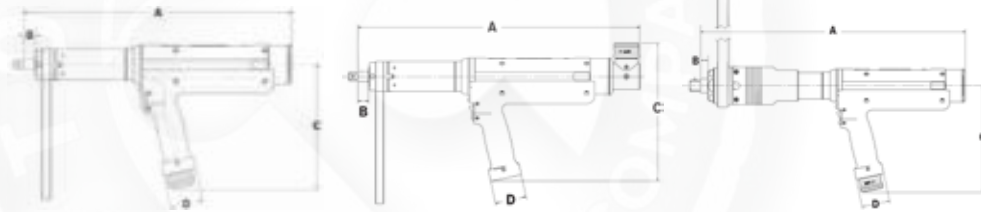

Extended Ergo Drive  
Bottom Exit (AV) Model

Extended Ergo Drive  
Top Exit (AVT) Model

Standard Square Drive  
Bottom Exit (A) Model

### 5000 Series Pistol Tools

Model	Max Torque		Torque Range		Free Speed RPM	Weight (-) Socket		Output SQ DR	(A)		(B)		(C)		(D)	
	NM	FT-LB	NM	FT-LB		LB	KG		IN	MM	IN	MM	IN	MM	IN	MM
5000 Series	V = Extended Ergo-Drive Output		T = Top Exit Models													
AEP35075AV(T)	75	55	19 - 75	14 - 55	944	9.2	4.17	1/2	AV = 15.95 AVT = 16.83	405.2 427.4	.68	17.4	AV = 7.44 AVT = 8.63	188.9 219	1.96	49.7
AEP35090AV(T)	90	66	23 - 90	17 - 66	767	9.2	4.17	1/2	AV = 15.95 AVT = 16.83	405.2 427.4	.68	17.4	AV = 7.44 AVT = 8.63	188.9 219	1.96	49.7
AEP35110AV(T)	110	81	28 - 110	21 - 81	634	9.2	4.17	1/2	AV = 15.95 AVT = 16.83	405.2 427.4	.68	17.4	AV = 7.44 AVT = 8.63	188.9 219	1.96	49.7
AEP35135AV(T)	135	99	34 - 135	25 - 99	515	9.2	4.17	1/2	AV = 15.95 AVT = 16.83	405.2 427.4	.68	17.4	AV = 7.44 AVT = 8.63	188.9 219	1.96	49.7
AEP35170AV(T)	170	125	43 - 170	32 - 125	418	9.2	4.17	1/2	AV = 15.95 AVT = 16.83	405.2 427.4	.68	17.4	AV = 7.44 AVT = 8.63	188.9 219	1.96	49.7
AEP35280A(T)	280	206	70 - 280	52 - 207	236	13.6	6.17	3/4	A = 18.51 AT = 19.41	470.3 493.1	.52	13.1	A = 7.44 AT = 8.59	188.9 217.9	1.96	49.7
AEP35350A(T)	350	258	88 - 350	65 - 258	192	13.6	6.17	3/4	A = 18.51 AT = 19.41	470.3 493.1	.52	13.1	A = 7.44 AT = 8.59	188.9 217.9	1.96	49.7
AEP35420A(T)	420	310	105 - 420	78 - 310	159	13.6	6.17	3/4	A = 18.51 AT = 19.41	470.3 493.1	.52	13.1	A = 7.44 AT = 8.59	188.9 217.9	1.96	49.7
AEP35515A(T)	515	380	128 - 515	95 - 380	129	13.6	6.17	3/4	A = 18.51 AT = 19.41	470.3 493.1	.52	13.1	A = 7.44 AT = 8.59	188.9 217.9	1.96	49.7
AEP35635A(T)(R)	635	468	159 - 635	117 - 469	104	13.6	6.17	3/4	A = 18.51 AT = 19.41	470.3 493.1	.52	13.1	A = 7.44 AT = 8.59	188.9 217.9	1.96	49.7

\* E logo indicates where ERGO-DRIVE sockets/extensions benefit tool operation.

### 5000 Series Angle Tools

- Provides the perfect solution for space-limited applications. Compact, durable head houses a precision right-angle gearset that fits into the tightest spaces
- Integrated transducer for accurate delivery or monitoring of Torque and Angle
- Lightweight materials and uniform body diameter provide a comfortable grip
- Ergonomically placed start lever for ease of operation
- Available in regular or flush socket options

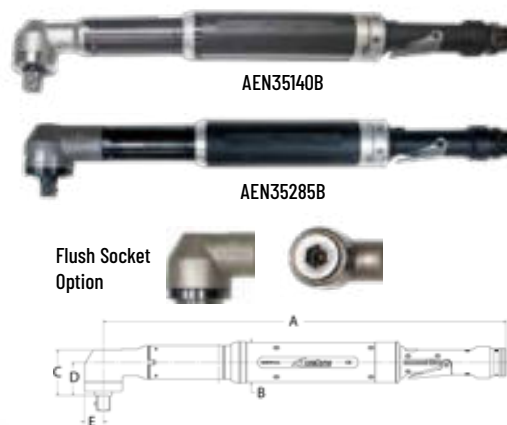

#### 5000 Series Angle Tools

Model	Max Torque		Torque Range		Free Speed RPM	Weight (-) Socket		Output SQ. DR	(A)		(B)		(C)		(D)		(E) B models only		
	NM	FT-LB	NM	FT-LB		LB	KG		IN	MM	IN	MM	IN	MM	IN	MM	IN	MM	
5000 Series	Add "F" to Part Numbers for Flush Socket																		
AEN35090B(F)	90	66	23 - 90	17 - 66	607	6.9	3.13	1/2	22.63	574.8	2.31	58.7	1.91	48.6	1.38	35.2	.81	20.6	
AEN35140B(F)	140	103	35 - 140	26 - 103	472	10.4	4.72	3/4	22.56	573	2.31	58.7	2.54	64.6	1.84	46.8	1.05	26.7	
AEN35175B(F)	175	129	44 - 175	33 - 129	384	10.5	4.76	3/4	22.56	573	2.31	58.7	2.54	64.6	1.84	46.8	1.05	26.7	
AEN35210BF	210	155	52 - 210	38 - 155	317	12.3	5.58	3/4	22.56	573	2.31	58.7	2.4	61	1.7	43.2	-	-	
AEN35225B(F)	225	166	56 - 225	41 - 166	291	12.3	5.58	3/4	22.92	582.2	2.31	58.7	2.86	72.6	1.94	49.1	1.25	31.8	
AEN35285B(F)	285	210	71 - 285	52 - 210	236	12.3	5.58	3/4	22.92	582.2	2.31	58.7	2.86	72.6	1.94	49.1	1.25	31.8	
AEN35350B(F)	350	258	88 - 350	65 - 258	191	12.3	5.58	3/4	22.92	582.2	2.31	58.7	2.86	72.6	1.94	49.1	1.25	31.8	

### 5000 Series Inline Tools

- Compact and durable, AcraDyne 5000 Series inline nutrunners are the ideal choice for fixtured fastening applications
- A uniform body diameter and a hex-shaped mounting point allow for simple installation into fixtured plates
- User modifiable reaction bar included with in-line tools for use in handheld applications
- Standard Square Drive or extended Ergo Drive output available on all models



#### 5000 Series Inline Tools

5000 Series  
75 - 170 Nm Models (1/2" Sq. Dr.)

5000 Series  
280 - 635 Nm Models (3/4" Sq. Dr.)

Model	Max Torque		Torque Range		Free Speed RPM	Weight (-) Socket		Output Sq. Dr	(A)		(B)		(C)		(D)		(E)		
	NM	FT-LB	NM	FT-LB		LB	KG		IN	MM	IN	MM	IN	MM	IN	MM	IN	MM	
5000 Series	V = Extended Ergo-Drive Output																		
AES35075AV	75	55	19 - 75	14 - 55	944	9.2	4.17	1/2	21.9	556.3	1.85	47	2.31	58.7	.68	17.4	1.78	45.2	
AES35090AV	90	66	23 - 90	17 - 66	767	9.2	4.17	1/2	21.9	556.3	1.85	47	2.31	58.7	.68	17.4	1.78	45.2	
AES35110AV	110	81	28 - 110	21 - 81	634	9.2	4.17	1/2	21.9	556.3	1.85	47	2.31	58.7	.68	17.4	1.78	45.2	
AES35135AV	135	100	34 - 135	25 - 100	515	9.2	4.17	1/2	21.9	556.3	1.85	47	2.31	58.7	.68	17.4	1.78	45.2	
AES35170AV	170	126	43 - 170	32 - 126	418	9.2	4.17	1/2	21.9	556.3	1.85	47	2.31	58.7	.68	17.4	1.78	45.2	
AES35280A	280	207	70 - 280	52 - 207	236	12.8	5.81	3/4	24.33	618.2	2.31	58.7	2.64	67.1	.52	13.1	1.78	45.2	
AES35350A	350	258	88 - 350	65 - 258	192	12.8	5.81	3/4	24.33	618.2	2.31	58.7	2.64	67.1	.52	13.1	1.78	45.2	
AES35420A	420	310	105 - 420	78 - 310	159	12.8	5.81	3/4	24.33	618.2	2.31	58.7	2.64	67.1	.52	13.1	1.78	45.2	
AES35515A	515	380	128 - 515	95 - 380	129	12.8	5.81	3/4	24.33	618.2	2.31	58.7	2.64	67.1	.52	13.1	1.78	45.2	
AES35635A	635	469	159 - 635	117 - 469	104	12.8	5.81	3/4	24.33	618.2	2.31	58.7	2.64	67.1	.52	13.1	1.78	45.2	

\* E logo indicates where ERGO-DRIVE sockets/extensions benefit tool operation.

## 5000 Series Fixtured Tools

- Rear & bottom exit available
- Standard Square Drive, Extended Ergo Drive, or 1/4" Quick Change outputs available in most models
- Models available with 1/2" fixed sq. dr., 3/4" fixed sq. dr., and 2" sliding spindle



**AEF35135AV**  
Extended Ergo Drive, Rear Exit Model



**AEF35350A**  
Standard Spindle, Rear Exit Model



**AEF35135AVB**  
Extended Ergo Drive, Bottom Exit Model



**AEF35135A-2**  
2" Sliding Spindle, Rear Exit Model



**AEF35135AB-2**  
2" Sliding Spindle, Bottom Exit Model

## 5000 Series Fixtured Tools

Model	Max Torque		Torque Range		Free Speed RPM	Weight (-) Socket		Output SQ. DR.
	NM	FT-LB	NM	FT-LB		LB	KG	
5000 Series	(V) = Extended Ergo Drive Output		(VB) = Extended Output with Bottom Exit Cable			(B) = Bottom Exit Cable		
	(-2) = 2" Sliding Spindle with Rear Exit Cable		(B-2) = 2" Sliding Spindle with Bottom Exit Cable					
AEF35075A(V)(VB)(-2)(B-2)	75	55	19 - 75	14 - 55	944	9.6	4.35	1/2"
AEF35090A(V)(VB)(-2)(B-2)	90	66	23 - 90	17 - 66	767	9.6	4.35	1/2"
AEF35110A(V)(VB)(-2)(B-2)	110	81	28 - 110	21 - 81	634	9.6	4.35	1/2"
AEF35135A(V)(VB)(-2)(B-2)	135	100	34 - 135	25 - 100	515	9.6	4.35	1/2"
AEF35170A(V)(VB)	170	125	43 - 170	32 - 125	418	9.6	4.35	1/2"
AEF35170A(-2)(B-2)	170	125	43 - 170	32 - 125	418	9.6	4.35	3/4"
AEF35280A*	280	207	70 - 280	52 - 207	236	13.6	6.17	3/4"
AEF35350A*	350	258	88 - 350	65 - 258	192	13.6	6.17	3/4"
AEF35420A*	420	310	105 - 420	77 - 310	159	13.6	6.17	3/4"
AEF35515A*	515	380	128 - 515	95 - 380	129	13.6	6.17	3/4"
AEF35635A*	635	469	159 - 635	117 - 469	104	13.6	6.17	3/4"

\* Item 28843 is a panel mount 2" sliding spindle for 280 - 635 Nm models.

## 5000 Series Fixtured Tool Dimensions

MODEL	(A)		(B)		(C)		(D)		(E)		(F)		(G)	
	IN	MM	IN	MM	IN	MM	IN	MM	IN	MM	IN	MM	IN	MM
AEF35075AV	18.04	458.2	11.55	293.3	1.85	47	1.75	44.4	6.92	175.9	1.56	39.6	.72	18.4
AEF35090AV	18.04	458.2	11.55	293.3	1.85	47	1.75	44.4	6.92	175.9	1.56	39.6	.72	18.4
AEF35110AV	18.04	458.2	11.55	293.3	1.85	47	1.75	44.4	6.92	175.9	1.56	39.6	.72	18.4
AEF35135AV	18.04	458.2	11.55	293.3	1.85	47	1.75	44.4	6.92	175.9	1.56	39.6	.72	18.4
AEF35170AV	18.04	458.2	11.55	293.3	1.85	47	1.75	44.4	6.92	175.9	1.56	39.6	.72	18.4
AEF35075A-2	23.48	596.3	11.55	293.3	1.85	47	1.75	44.4	6.92	175.9	1.59	40.4	2.23	56.6
AEF35090A-2	23.48	596.3	11.55	293.3	1.85	47	1.75	44.4	6.92	175.9	1.59	40.4	2.23	56.6
AEF35110A-2	23.48	596.3	11.55	293.3	1.85	47	1.75	44.4	6.92	175.9	1.59	40.4	2.23	56.6
AEF35135A-2	23.48	596.3	11.55	293.3	1.85	47	1.75	44.4	6.92	175.9	1.59	40.4	2.23	56.6
AEF35170A-2	23.48	596.3	11.55	293.3	1.85	47	1.75	44.4	6.92	175.9	1.59	40.4	2.23	56.6
AEF35280A	20.48	520.2	11.55	293.3	2.14	54.4	2.64	67.1	9.28	235.7	1.56	39.6	.52	13.1
AEF35350A	20.48	520.2	11.55	293.3	2.14	54.4	2.64	67.1	9.28	235.7	1.56	39.6	.52	13.1
AEF35420A	20.48	520.2	11.55	293.3	2.14	54.4	2.64	67.1	9.28	235.7	1.56	39.6	.52	13.1
AEF35515A	20.48	520.2	11.55	293.3	2.14	54.4	2.64	67.1	9.28	235.7	1.56	39.6	.52	13.1
AEF35635A	20.48	520.2	11.55	293.3	2.14	54.4	2.64	67.1	9.28	235.7	1.56	39.6	.52	13.1

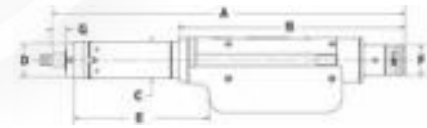

Extended Ergo Drive Output (AV) Models

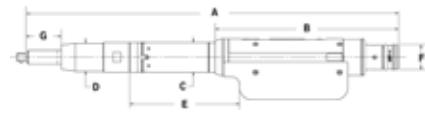

2" Sliding Spindle (A-2) Models

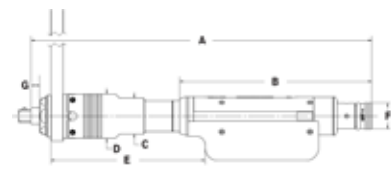

Standard Spindle (A) Models

\* E logo indicates where ERGO-DRIVE sockets/extensions benefit tool operation.

## 5000 Series Hold-and-Drive Tools

- Torques ranging from 90 Nm – 350 Nm
- Very robust design
- 1" and 2" travels are standard
- Sockets and holders are custom

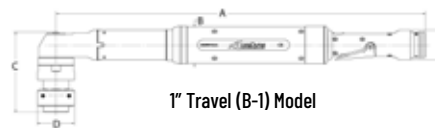

1" Travel (B-1) Model

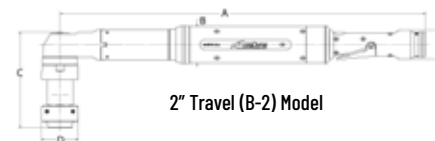

2" Travel (B-2) Model

### 5000 Series Hold and Drive Tools

Model*	Max Torque		Torque Range		Free Speed RPM	Weight (LB)	Min Socket	Max Socket	(A)		(B)		(C)		(D)		(E)	
	NM	FT-LB	Nm	FT-LB					IN	MM	IN	MM	IN	MM	IN	MM	IN	MM
AEH35090B(-1)(-2)	90	66	23 - 90	17 - 66	607	-1 = 7.6 -2 = 7.9	9/16 (14 mm) 1-1/4 (32 mm)		22.63	574.8	2.31	58.7	-1 = 4.02 -2 = 4.96	102.1 126	1.88	47.6	1.78	45.2
AEH35140B(-1)(-2)	140	103	35 - 140	26 - 103	472	-1 = 10.6 -2 = 11.0	5/8 (15 mm) 1-1/4 (32 mm)		22.56	572.9	2.31	58.7	-1 = 4.87 -2 = 5.87	123.7 149.1	2.25	57.15	1.78	45.2
AEH35175B(-1)(-2)	175	129	44 - 175	33 - 129	384	-1 = 10.6 -2 = 11.1	5/8 (15 mm) 1-1/4 (32 mm)		22.52	571.9	2.31	58.7	-1 = 4.87 -2 = 5.87	123.7 149.1	2.25	57.15	1.78	45.2
AEH35225B(-1)(-2)	225	166	56 - 225	41 - 166	291	-1 = 12.9 -2 = 13.3	3/4 (19 mm) 1-1/4 (32 mm)		22.92	582.2	2.31	58.7	-1 = 5.52 -2 = 6.52	140.1 165.5	2.63	66.7	1.78	45.2
AEH35285B(-1)(-2)	285	210	71 - 285	52 - 210	236	-1 = 12.9 -2 = 13.3	3/4 (19 mm) 1-1/4 (32 mm)		22.92	582.2	2.31	58.7	-1 = 5.52 -2 = 6.52	140.1 165.5	2.63	66.7	1.78	45.2
AEH35350B(-1)(-2)	350	258	88 - 350	65 - 258	191	-1 = 12.9 -2 = 13.3	3/4 (19 mm) 1-1/4 (32 mm)		22.92	582.2	2.31	58.7	-1 = 5.52 -2 = 6.52	140.1 165.5	2.63	66.7	1.78	45.2

### SPECIALTY GEARHEADS

AIMCO can provide specialized heads for most any application. Tubenut, Hold and Drive, Crow Foot, Offsets, and Sliding Spindles are just a few of the head styles available. Whatever the requirements, AIMCO will recommend the head configuration that will get the job done successfully.

Contact an AIMCO Customer Service Associate for more details, 1-503-254-6600, or toll free 1-800-852-1368.



# AcraDyne Riv-Nut Tools

## AcraDyne Riv-Nut Tools

Offering the same size, speed, and duty cycle benefits of 1000 and 2000 series tools, AcraDyne's Riv-Nut tools have a simple, quick mandrel change design and are suitable for a wide range of material thicknesses – limited only by rivet nut size.

### FEATURES AND BENEFITS

- Pull-to-torque tool/controller system ensures accurate, repeatable, and measurable tightening every time
- 1000 & 2000 series tools available with bottom exit, rear exit, or top exit cable configurations. Fixtured, and Push-to-Start models are available by request. Contact AIMCO at 1-503-254-6600, or toll free 1-800-852-1368
- Low-friction coating on mandrel for extended life
- Precise control of rivet compression with Torque and Angle detection capability
- Data collection and networking capabilities to capture and utilize result data for QMS systems and line controls
- Multi-function button (MFB) provides increased flexibility
- On-board lights and audible signal for operator feedback
- Works with rivet sizes M4 - M10 or 8-32 - 3/8-16



### 1000 & 2000 Series Riv-Nut Tools

Model*	Torque Range		Free Speed RPM	Weight (-) Socket		Thread Size	Dimensions								
	NM	FT-LB		LB	KG		(A) IN	(A) MM	(B) IN	(B) MM	(C) IN	(C) MM	(D) IN	(D) MM	
<b>Pistol</b>															
1000 Series	4A Models = Bottom Exit		4R Models = Rear Exit		4T Models = Top Exit										
AEP4(A)(R)2006BR	1.5 - 6	1.1 - 4.4	2,625	2.2	1.00	M4 x 0.7 mm M5 x 0.8 mm	8-32 UNC 10-24 UNC	9.68	245.9	1.05	26.7	6.01	152.6	1.96	49.8
AEP4(A)(R)2014BR	3.5 - 14	2.6 - 10	1,037	2.3	1.04	M6 x 1.0 mm M8 x 1.25 mm	10-32 UNF 1/4-20 UNC	9.68	245.9	1.05	26.7	6.87	174.5	1.96	49.8
AEP4(A)(R)2022BR	5.5 - 22	4.1 - 16	656	2.3	1.04	M10 x 1.5 mm	5/16-18 UNC 3/8-16 UNC	9.68	245.9	1.05	26.7	6.87	174.5	1.96	49.8
2000 Series	4A Models = Bottom Exit		4R Models = Rear Exit		4T Models = Top Exit										
AEP4(A)(R)(T)22020BR	5 - 20	3.7 - 15	1,313	2.4	1.09	M4 x 0.7 mm M5 x 0.8 mm	8-32 UNC 10-24 UNC	10.18	258.6	1.05	26.7	6.87	174.5	1.96	49.8
AEP4(A)(R)(T)22030BR	7.5 - 30	5.5 - 22	840	2.4	1.09	M6 x 1.0 mm M8 x 1.25 mm	10-32 UNF 1/4-20 UNC	10.18	258.6	1.05	26.7	6.87	174.5	1.96	49.8
AEP4(A)(R)(T)22040BR	10 - 40	7.4 - 30	656	2.4	1.09	M10 x 1.5 mm	5/16-18 UNC 3/8-16 UNC	10.18	258.6	1.05	26.7	6.87	174.5	1.96	49.8
<b>Straight</b>															
2000 Series															
AES4A22020CR	5 - 20	3.7 - 14.8	1,313	2.8	1.3	M4 x 0.7 mm M5 x 0.8 mm	8-32 UNC 10-24 UNC	16.4	417.3	1.7	43.2	7.04	178.7	1.38	34.9
AES4A22040CR	10 - 40	7.4 - 29.5	656	2.8	1.3	M6 x 1.0 mm M8 x 1.25 mm M10 x 1.5 mm	10-32 UNF 1/4-20 UNC 5/16-18 UNC 3/8-16 UNC	16.4	417.3	1.7	43.2	7.04	178.7	1.38	40.4

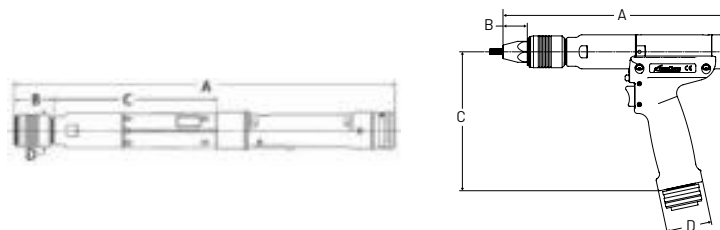



# AcraDyne High Torque DC Tools

Critical bolting demands tools that deliver high torque with superior performance. Couple with AcraDyne's Controller, the HT Series tools combine these features in an electric, high-torque bolting system that beats the competition in accuracy, speed, and safety.

## FEATURES AND BENEFITS

- Built-in integral transducer for optimal monitoring and control
- One of the most accurate high-torque tools in the world
- 250 Nm - 17,000 Nm torque range
- Ergonomic, robust design with five handle configurations that are also available in dual-lever models
- The world's most advanced traceable system at the output
- Three tightening strategies:
  - *Torque Control*: Drive the tool to a pre-set Target Torque
  - *Angle Control*: Drive the tool to or measure a pre-set Degree of Angle
  - *Yield Control*: Drive the tool to the Fastener Yield Point to achieve maximum clamp load
- Data retrieval
- Optional rugged carrying/storage case available
- Optional tool fan available in models 8,100 NM and above
- **DESIGNED AND ASSEMBLED IN THE USA**



Pistol Type (AEP)



Axial Type (AEJ)



Straight Lever Type (AES)



Rear Mounted Pistol (AED)



Fixtured Type (AEF)

## HT Fixed Gearcase Tools

Model	Approx. Torque NM FT-LB		Approx. Speed RPM	Weight KG LB		Total Length (incl sq. dr) MM IN		Dia. MM IN	Drive IN	Sound Level dB(A)	
<b>HT Series Fixed Gearcase Models (R) = Pistol Tool with Rear Exit Cable (B) = Fixtured Model with Bottom Exit Cable</b>											
<b>6000 Series</b>											
AE (P) 4A66250B (R) AE (D) (S) (J) (F) 4A66250B	250	185	315	4.6	10.5	P = 289 D = 388 S = 440 J = 331 F = 331	11.4 13 15.3 13 13	66	2.6	0.75	66
AE (P) 4A66425B (R) AE (D) (S) (J) 4A66425B AE (F) 4A66425B (B)	425	315	165	4.6	10.5	P = 289 D = 388 S = 440 J = 331 F = 331	11.4 13 15.3 13 13	66	2.6	0.75	66
AE (P) A66625B (R) AE (D) (S) (J) 4A66625B AE (F) 4A66625B (B)	625	460	106	4.8	10.5	P = 289 D = 388 S = 440 J = 331 F = 331	11.4 13 15.3 13 13	66	2.6	0.75	66
AE (P) 4A66925B (R) AE (D) (S) (J) (F) 4A66925B	925	682	72	4.8	10.5	P = 289 D = 388 S = 440 J = 331 F = 331	11.4 13 15.3 13 13	66	2.6	0.75	66
<b>7000 Series</b>											
AE (F) 4A76200BB	200	148	432	5.2	11.5	P = 302 D = 397 S = 453 J = 343 F = 343	11.9 15.6 17.8 13.5 13.5	67.3	2.7	0.75	66
AE (P) (D) (S) (J) (F) 4A771000B	1,000	738	65	6.6	14.5	P = 302 D = 397 S = 453 J = 343 F = 343	11.9 15.6 17.8 13.5 13.5	77.5	3.1	1	66
AE (P) (D) (S) (J) 4A772500B AE (F) 4A772500B (B)	2,500	1,844	25	7.5	16.5	P = 337 D = 433 S = 488 J = 379 F = 379	13.3 17.0 19.2 14.9 14.9	77.5	3.1	1	66
<b>8000 Series</b>											
AE (P) (D) (J) (F) 4A884200B1 AE (P) (D) (S) (J) (F) 4A884200B	4,200	3,100	12	11.1	24.5	P = 384 D = 480 S = 546 J = 410 F = 410	15.1 18.9 21.5 16.1 16.1	91.2	3.6	B1 = 1 B = 1.5	66
AE (P) (D) (J) (F) 4A885000B	5,000	3,700	9.3	11.1	24.5	P = 384 D = 480 S = 546 J = 410 F = 410	15.1 18.9 21.5 16.1 16.1	91.2	3.6	1.5	66
AE (P) (D) (J) (F) 4A896500B AE (F) 4A896500B (B)	6,500	4,800	7	15.7	34.5	P = 438 D = 533 S = 599 J = 463 F = 462	17.2 21 23.6 18.2 18.2	103.8	4.1	1.5	66
AE (P) (D) (S) (J) (F) 4A898100B	8,100	6,000	5	15.7	34.5	P = 438 D = 533 S = 599 J = 463 F = 462	17.2 21 23.6 18.2 18.2	103.8	4.1	1.5	66

\* 8,100 Nm - 17,000 Nm models are not supported by the Gen III controller platform. The Gen IV controller platform is required.

# AcraDyne High Torque DC Tools

## 360° Swivel Gearcase Nutrunners

### FEATURES AND BENEFITS

- Same features and benefits of fixed gearcase models
- Ergonomic, robust design with two handle configurations



2,800 Nm Torque  
AEP4W872800B



8,100 Nm Torque  
AEJ4B898100B



8,100 Nm Torque  
AEP4B898100B

## HT 360° Swivel Gearcase Tools

Model	Approx. Torque NM	Approx. Torque FT-LB	Approx. Speed RPM	Weight KG	Weight LB	Length (incl sq. dr) MM	Length (incl sq. dr) IN	Dia. MM	Dia. IN	Drive IN	Sound Level dB(A)
<b>HT Series 360° Swivel Gearcase Models (R) = Pistol Tool with Rear Exit Cable</b>											
<b>6000 Series</b>											
AE (P) 4B66250B(R) AE (D)(J) 4B66250B	250	185	315	5.3	12	P = 327 P(R) = 368 D = 429 J = 369	12.9 14.5 16.9 14.5	67.3	2.7	0.75	66
AE (P) 4B66425B(R) AE (D)(J) 4B66425B	425	315	165	5.3	12					0.75	66
AE (P) 4B66625B(R) AE (D)(J) 4B66625B	625	460	106	5.5	12					0.75	66
AE (P) 4B66925B(R) AE (D)(J) 4B66925B	925	682	72	5.5	12					0.75	66
<b>7000 Series</b>											
AE (P)(J) 4B771000B	1,000	738	65	7.3	16	P = 339 J = 381	13.4 15	77.5	3.1	1	66
AE (P)(J) 4B772500B	2,500	1,844	25	8.2	18	P = 377 J = 418	14.8 16.5				
<b>8000 Series</b>											
AE (P)(D)(J) 4B884200B1 AE (P)(D)(J) 4B884200B	4,200	3,100	12	11.8	26	P = 422 D = 518 J = 446	16.6 20.4 17.6	91.2	3.6	B1 = 1 B = 1.5	66
AE (P)(J) 4B896500B	6,500	4,800	7	16.4	36	P = 475 J = 499	18.7 19.7	103.8	4.1	1.5	66
AE (P)(D)(J) 4B898100B* AE (P) 4B998100B*	8,100	6,000	5	16.4	36	P = 475 D = 571 J = 499	18.7 22.5 19.7	103.8	4.1	1.5	66
AE (P) 4B998100B*	8,100	6,000	5	21.8	48	532	20.9	112	4.4	1.5	66
<b>Models for Extreme Duty / Low Power Environments</b>											
<b>Wind Series</b>											
AE (P)(J) 4W872800B	2,800	2,065	9	10.0	22	P = 406 J = 430	16 17	76	3.0	1	66
AE (P)(D)(J) 4W885000B1* AE (P)(D)(J) 4W885000B*	5,000	3,700	4.5	11.8	26	P = 422 D = 518 J = 446	16.6 20.4 17.6	91.2	3.6	B1 = 1 B = 1.5	66

\* 8,100 Nm - 17,000 Nm models are not supported by the Gen III controller platform. The Gen IV controller platform is required.

AIMCO can provide customized tooling solutions for even the most unique applications. Let us propose a solution tailored to your needs. Contact an AIMCO Customer Service Associate for more details, 1-503-254-6600, or toll free 1-800-852-1368.

# AcraDyne High Torque DC Angle Tools

AcraDyne HT DC Angle Tools provide the perfect solution for space-limited applications. Compact, durable head houses a precision right-angle gearset that fits into the tightest spaces

## FEATURES AND BENEFITS

- Transducerized closed loop control at the output like all AcraDyne HT-Series tools
- These low-profile head, small-diameter, lever-operated tools, with the torque measured at the output, offer a unique solution
- The torque reported is the torque delivered
- One of the most accurate high-torque right-angle tools in the world
- Smallest tools of their kind on the market
- Same durable, high-cycle gearing as our other HT-series tools
- Models up to 17,000 Nm available upon request
- These models are fixtured tools



## 5000 Series HT Angle Tools

MODEL	Max. Torque*		Torque Range		Free Speed RPM	Weight		Output SQ Drive	Dimensions									
	NM	FT-LB	NM	FT-LB		LB	KG		A		B		C		D		E	
									IN	MM	IN	MM	IN	MM	IN	MM	IN	MM
AEN356540A	540	398	135 - 540	100 - 398	109	13.1	5.95	3/4"	22.58	573.6	2.31	58.7	4.75	120.6	4.05	102.8	1.33	33.7
AEN3571000A	1,000	737	250 - 1,000	184 - 737	61	16.3	7.39	1"	22.92	582.2	2.31	58.7	5.36	136.1	4.44	112.7	1.53	38.7
AEN3571600A	1,600	1,180	400 - 1,600	295 - 1,180	33	16.7	7.57	1"	22.92	582.2	2.31	58.7	5.36	136.1	4.44	112.7	1.53	38.7
AEN3572600A	2,600	1,917	650 - 2,600	479 - 1,917	21	18.5	8.40	1"	22.92	582.2	2.31	58.7	6.77	171.9	5.86	148.8	1.53	38.7

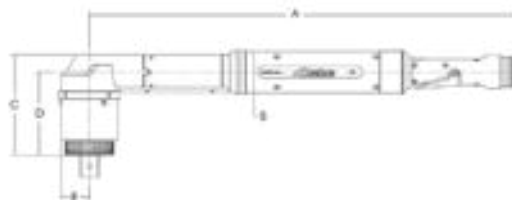

# A BETTER ANGLE ON BIG JOBS



## AcraDyne HT DC Angle Nutrunner is THE Tool for Servicing Blades on Wind Turbines



This **unique tool configuration**, built with all of the AcraDyne HT advantages, is made in a size that allows access to blade bolts that cannot be easily accessed by other continuous drive tools. The 360° swivel gearcase allows for precise placement of the tool reaction bar against reactive surfaces for ease of use.



# AcraDyne High Torque DC Angle Tools

AcraDyne's HT DC angle nutrunner is one of the smallest tools of its kind on the market. A powerful motor combined with a short-length handle and a 360° swivel gearcase gives you ultimate flexibility in limited-space applications.

## FEATURES AND BENEFITS

- Easy access to previously hard-to-reach blade bolts
- Faster speed than hydraulic tools
- Acquires data in both loosening and retightening directions
- Preset strategies and sequencing for ease of use
- Most intuitive user interface in the industry for setup and data transfer
- Slip ring gearbox for 360° reaction bar movement
- Dual-lever option available
- Measures traceable, dynamic torque directly at the square drive, and the built-in transducer ensures accurate torque values. The torque reported is the torque delivered
- One of the most accurate high-torque right-angle tools in the world
- Same durable, high-cycle gearing as AcraDyne's industry-leading HT series tools
- Available with an optional rugged, weather-resistant carrying case



Custom reaction bars available

## 7000 Series HT DC Angle Tools

Model*	Max. Torque		Torque Range		Free Speed RPM	Length (Minus Reaction Bar)		Weight		Output SQ DRIVE
	NM	FT-LB	NM	FT-LB		IN	MM	LB	KG	
AEN4B771200B(DL)	1,200	885	240 - 1,200	177 - 885	38	16.6	422	17.9	8.1	1"
AEN4B773000B(DL)	3,000	2,200	600 - 3,000	443 - 2,200	15	16.6	422	20.4	9.3	1"

\* Add "DL" to Part Numbers for Dual Lever

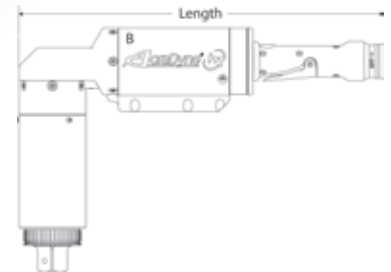

## Gen IV iEC4W Field Controller: High Torque with High Tech

The Gen IV Field Controller (see page 43) is the core of the modular AcraDyne DC system. One controller will command any tool in the AcraDyne line – including the HT DC Angle Tool – from 1 Nm to 17,000 Nm, all with the same modular standard cable design.

# AcraDyne High Torque DC Dual-Lever Tools

## HIGH TORQUE DUAL-LEVER TOOLS

Provides Additional Safety by Avoiding Accidental Tool Start

### FEATURES AND BENEFITS

- Built-in integral transducer for optimal monitoring and control
- One of the most accurate high-torque tools in the world
- 250 Nm - 17,000 Nm
- Two-Hand No Tie Down Operation
  - No Tie Down Control: Operator must have both hands on and activating the dual-starting mechanisms simultaneously. Both hands must remain in position, activating the dual controls, at all times in order for the tool to operate.
- Additional safety when using a tool with a reaction bar or nose extension. Operator's hands remain on the controls and not in a position where they could be impacted by reaction devices
- Hands stay clear of application
- Helps avoid accidental starting of the tool
- Available in Fixtured (F), J-Handle (J), Straight (S), as well as dual-handle configurations
- **DESIGNED AND ASSEMBLED IN THE USA**



AEJ Type



AEF Type



AED Type



AES Type

HT Dual-Lever Nutrunners: **SAFETY** is **VITAL** in Critical Bolting

AcraDyne's Nutrunners are designed with ultimate operator safety in mind. The optional dual-lever design helps prevent:



**!** **Injuries from Accidental Tool Start**

Two-hand operation with no tie-down feature requires the operator to use both hands on the trigger simultaneously. This eliminates the possibility of accidental tool start and keeps both of the operator's hands out of harm's way.

**!** **Strain Caused by Awkward Tool Operation**

Multiple handle styles ensure the safest, most ergonomic tool for your specific application.

**!** **Hand and Finger Trauma**

Significantly reduce the risk of crushed or mutilated fingers from unintended tool start.

**Protect your most valuable asset – your tool operator.**

# AcraDyne High Torque DC Dual-Lever Tools



## HT Fixed Gearcase Dual-Lever Tools

Dual Lever Model	Approx. Torque		Approx. Speed RPM	Weight		Length (incl sq. dr)		Dia.		Drive IN	Sound Level dB(A)	
	NM	FT-LB		KG	LB	MM	IN	MM	IN			
<b>HT Series Fixed Gearcase: Dual-Lever Models</b> For Straight Type Tools Only: (L) = Left-Side Handle (R) = Right-Side Handle												
<b>6000 Series</b>												
AE(P)(F)4A66250BDL AE(S)4A66250BDL(L)(R)	250	185	315	3.9	9	P = 314 12.4 F = 331 13 S = 440 17.3	67.3	2.7		0.75	66	
AE(P)(F)4A66425BDL AE(S)4A66425BDL(L)(R)	425	315	165	3.9	9					0.75	66	
AE(P)(F)4A66625BDL AE(S)4A66625BDL(L)(R)	625	460	106	4.1	9					0.75	66	
AE(P)(F)4A66925BDL AE(S)4A66925BDL(L)(R)	925	682	72	4.1	9					0.75	66	
<b>7000 Series</b>												
AE(P)(F)4A771000BDL AE(S)4A771000BDL(L)(R)	1,000	738	65	5.9	13	P = 324 12.7 F = 343 13.5 S = 453 17.8	77.5	3.1	1	66		
AE(P)(F)4A772500BDL AE(S)4A772500BDL(L)(R)	2,500	1,844	25	6.8	15	P = 359 14.1 F = 379 14.9 S = 488 19.2	77.5	3.1	1	66		
<b>8000 Series</b>												
AE(F)4A884200B1DL AE(F)4A884200BDL	4,200	3,100	12	10.4	23	P = 438 17.2 F = 462 18.2 J = 462 18.2	91.2	3.6	B1 = 1 B = 1.5	66		
AE(F)4A885000BDL	5,000	3,700	9.3	10.4	23		410	16.1	91.2	3.6	1	66
AE(P)(F)4A896500BDL	6,500	4,800	7	15.0	33		102.4	4	1.5	66		
AE(F)(J)4A898100BDL*	8,100	6,000	5	15.0	33		102.4	4	1.5	66		

\* 8,100 Nm - 17,000 Nm models are not supported by the Gen III controller platform. The Gen IV controller platform is required.

## HT 360° Swivel Gearcase Dual-Lever Tools

Dual Lever Model	Approx. Torque		Approx. Speed RPM	Weight		Length (incl sq. dr)		Dia.		Drive IN	Sound Level dB(A)
	NM	FT-LB		KG	LB	MM	IN	MM	IN		
<b>HT Series 360° Swivel Gearcase: Dual-Lever Models</b> For Straight Type Tools Only: (L) = Left-Side Handle (R) = Right-Side Handle											
<b>6000 Series</b>											
AE(P)(F)4B66250BDL AE(S)4B66250BDL(L)(R)	250	185	315	4.6	10.5	P = 353 13.9 F = 369 14.5 S = 630 24.8	67.3	2.7	0.75	66	
AE(F)4B66425BDL AE(S)4B66425BDL(L)(R)	425	315	165	4.6	10.5					66	
AE(F)4B66625BDL AE(S)4B66625BDL(L)(R)	625	460	106	4.8	10.5					66	
AE(F)4B66925BDL AE(S)4B66925BDL(L)(R)	925	682	72	4.8	10.5					66	
<b>7000 Series</b>											
AE(P)(F)4B771000BDL AE(D)4B771000BDL(L) AE(S)4B771000BDL(L)(R)	1,000	738	65	6.6	14.5	P = 361 14.2 F = 343 13.5 D = 438 17.2 S = 492 19.4	77.5	3.1	1	66	
AE(D)4B771800BDL(L)	1,800	1,328	28	7.5	16.5	475 18.7	77.5	3.1	1	66	
AE(P)(F)4B772500BDL AE(D)4B772500BDL(L) AE(S)4B772500BDL(L)(R)	2,500	1,844	25	7.5	16.5	P = 398 15.7 F = 379 14.9 D = 475 18.7 S = 528 20.8	77.5	3.1	1	66	
<b>8000 Series</b>											
AE(P)(F)4B896500BDL	6,500	4,800	5	16.4	36	P = 475 18.7 F = 499 19.7	104	4.1	1.5	66	
AE(J)4B898100BDL*	8,100	6,000	5	16.4	36	499 19.7	104	4.1	1.5	66	

\* 8,100 Nm - 17,000 Nm models are not supported by the Gen III controller platform. The Gen IV controller platform is required.

AIMCO can provide customized tooling solutions for even the most unique applications. Let us propose a solution tailored to your needs. Contact an AIMCO Customer Service Associate for more details, 1-503-254-6600, or toll free 1-800-852-1368.

# AcraDyne HTXD Extreme Duty High Torque Tools

AcraDyne® HTXD

**EXTREME  
DUTY**



**Full-Strength Tools for Big Jobs**

**AcraDyne's HTXD Nutrunner/Gen IV Controller System is one of the Most Accurate High-Torque Bolting Systems in the World**



- Measures traceable, dynamic torque directly at the square drive, and the built-in transducer ensures accurate torque values. The torque reported is the torque delivered
- Available in J handle and Pistol handle configurations
- Extreme Duty engineering with motors rated for bolting applications near continuous duty
- Patented dual J-Handle models have additional safety features: Operators must use both hands on the trigger simultaneously, eliminating the possibility of accidental tool start and keeping both of the operator's hands out of harm's way
- Wide range of tightening strategies available including Torque Control, Torque plus Angle, Angle Control, and Yield Control



# AcraDyne HTXD Extreme Duty High Torque Tools



AcraDyne's HTXD Systems measure traceable, dynamic torque directly at the square drive and the built-in transducer ensures accurate torque values.

- Accuracy and traceability are assured from the first fastening to the last
- Torque reported is the torque delivered
- Accuracy not affected by gearing efficiency

Tools with the gearing after the transducer cannot claim this!



## HT 360° Swivel Gearcase Bolting Tools for Extreme Duty

Model	Series	Approx. Torque		Approx. Speed RPM	Weight *		Length (incl sq. dr)		Dia.		Drive IN	Sound Level dB(A)
		NM	FT-LB		KG	LB	MM	IN	MM	IN		
AEJ = J Handle/Axial Type    AEP = Pistol Type    AEF = Fixtured Type Single-Handle Models Standard. Add "DL" to Model Numbers for Dual Handles (AEJ models only)												
Fixed Gearcase												
AEF4A996500B	9000	6,500	4,800	5.8	19	42	494	19.5	104	4.1	1.5	66
360° Swivel Gearcase												
AEP4W998100B	9000	8,100	6,000	2.3	21.8	48	544	21.4	104	4.1	1.5	66
AEJ4W998100B	9000	8,100	6,000	2.3	21.8	48	544	21.4	104	4.1	1.5	66
AEJ4U998100BDL	9000	8,100	6,000	2.3	21.8	48	427	16.8	104	4.1	1.5	66
AEP4W9X12000B	9X	12,000	8,850	2	31.8	70	572	22.5	131	5.2	1.5	66
AEJ4W9X12000B	9X	12,000	8,850	2	31.8	70	572	22.5	131	5.2	1.5	66
AEJ4U9X12000BDL	9X	12,000	8,850	2	31.8	70	441	17.4	131	5.2	1.5	66
AEP4W9Y17000B	9Y	17,000	12,500	1	42.6	94	381	15	153	6.0	2.5	66
AEJ4W9Y17000B	9Y	17,000	12,500	1	42.6	94	381	15	153	6.0	2.5	66
AEJ4U9Y17000BDL	9Y	17,000	12,500	1	42.6	94	458	18	153	6.0	2.5	66

\* Weight is tool only w/o Socket and Reaction Bar

# AcraDyne HTXD Extreme Duty High Torque Tools



## EXTREME DUTY

### Ultimate Operator Safety for Lifting Larger Bolting Tools

AcraDyne's XD Lift Assist device for tool suspension and use allows for easy handling of equipment that otherwise would need two operators to position.

#### FEATURES AND BENEFITS

- Lift can be assembled/disassembled in less than 15 minutes
- Can be used inside wind turbines at deck platforms
- Designed for a wide variety of applications including narrow tower platforms and ladder spaces
- Lift Assist weighs 30 kg / 67 lbs
- Weight of unit is below the weight allowed to be lifted by personnel inside or outside the tower
- Disassembled Lift Assist is transported in a load-rated bag that can be lifted manually or by hoist within the tower
- Device is rated for loads up to 200 kg / 440 lbs
- Full-swivel wheels with locking brakes make movement and repositioning easy



AXD-2000  
Lift Assist



# AcraDyne Gen IV Field Controller

Improved design of AcraDyne's powerful Gen IV Field Controller means increased durability, lighter weight, and quick and easy setup



iEC4WF Field Controller







Rugged, Lightweight Case

## FEATURES AND BENEFITS

- Optimized for extreme duty applications >5,000 Nm
- The Gen IV Controller utilizes three tightening strategies:
  - Torque Control: Drive the tool to a pre-set Target Torque
  - Angle Control: Drive the tool to or measure a pre-set Degree of Angle
  - Yield Control: Drive the tool to the Fastener Yield Point to achieve maximum clamp load
- Multiple fastening strategies – Program up to 256 parameters with as many as 20 steps
- Jobs capability – 99
- Real-time curve viewing. Curve storage – 20,000
- Rundown storage – 1,000,000
- Event log – 5,000
- Backup & restore through USB
- Weatherproof, rugged case protects from the toughest environments
- Compact design weighs less than 20 lbs
- Ground clamp is quick and easy to set up and eliminates additional parts that are substantially heavy
- Optional tool fan kit helps prevents tool overheating
- Capable of interface with the AcraDyne series Dual-Lever tools that offer two-hand, no tie down functionality
- 110V – 220V compatible
- Single Ethernet port increases speed of connectivity, signal stability, and signal consistency
- Commands any tool in the AcraDyne line from 1 Nm to 17,000 Nm, all with one cable

## PERQ Advantages

- |  |  |
|--|--|
| <br><b>PRODUCTIVITY</b> | <ul style="list-style-type: none"> <li>• Replace multiple conventional tools with one flexible controlled system</li> <li>• Quick and easy setup</li> <li>• Fan kit reduces downtime due to tool overheating</li> </ul>  |
| <br><b>ERGONOMICS</b>   | <ul style="list-style-type: none"> <li>• Compact, rugged case with easy carry handle makes field use easy and convenient</li> <li>• Lightweight for operator comfort</li> </ul>  |
| <br><b>RELIABILITY</b>  | <ul style="list-style-type: none"> <li>• Weatherproof rugged case</li> <li>• Industrial touch screen</li> </ul>  |
| <br><b>QUALITY</b>      | <ul style="list-style-type: none"> <li>• Controlled tightening and consistent torque control improves quality</li> <li>• Process controls reduce human error, and ensure no missed fasteners, stripped threads, rehits, or damaged threads</li> <li>• No premature shut-off</li> </ul> |

Model	Description	Dimensions W x D x H	Weight	
			LB	KG
iEC4WF	Field use controller for use with 110V or 220V service	16.1" x 12.8" x 6.9" 408 mm x 326 mm x 175 mm	18.5	8.4



## NOSE EXTENSIONS

### FEATURES AND BENEFITS

- Ideal for hard-to-reach applications when a torque tube, or arm, is not desirable
- A cost-effective, more flexible option compared to a multiple spindle system
- Common applications:
  - Wheel install and repair stations
  - Large flange assembly
  - Mining vehicle shovel bolts
  - Railway equipment maintenance
  - Oil and gas industry well fixtures



28050



28480

## HT GEARHEAD TOOLS

### FEATURES AND BENEFITS

- Application-specific, custom made tools fit virtually any application
- Same durable gearing as found on AcraDyne's standard HT series tools
- Model types available:
  - HT Offset Gearhead tools
  - HT Right Angle with Offset Gearhead tools
  - HT Right Angle Air tools with Offset Gearhead

Custom accessories are available for your application. Contact an AIMCO Customer Service Associate for more details, 1-503-254-6600, or toll free 1-800-852-1368.



# AcraDyne High Torque Accessories

## ACCESSORIES

Custom accessories are available for your application; contact an AIMCO Customer Service Associate for details, 1-503-254-6600, or toll free 1-800-852-1368.



Model	Description
26477	Swivel Bail, 6000 Series
26327	Swivel Bail, 7000 Series
25287	Swivel Bail, 8000 Series
26630	Swivel Bail, 8000/9000 Series Tools
26478	Swivel D-Handle, 6000 Series
26328	Swivel D-Handle, 7000 Series
25291	Swivel D-Handle, 8000 Series
26479	Stationary Bail, 6000 series (26336 handle not included)
26332	Stationary Bail, 7000 series (26336 handle not included)
25289	Stationary Bail, 8000 series (26336 handle not included)
26336	Fixed Handle (for use with 26479, 26332, 25289)
26337	Rear Fixed Hoist Ring, 6000/7000/8000 Series Pistols
28514	Rear Folding Hoist Ring Kit for 8000 Series Pistols
28549	Sliding Spindle, 6000 Series
27045	Sliding Spindle, 7000 Series
30300	Sliding Spindle, 8000 Series

## REACTION BARS



HT tool includes a standard, spline attachment reaction device. Custom reaction devices are available. Contact an AIMCO Customer Service Associate for more details, 1-503-254-6600, or toll free 1-800-852-1368.

	Model	Description
 Single Ended Flat	26810	6000 Series
	26800	7000 Series
	25277	8000 Series
	27255	9000 Series
	30303	X Series
 Single Ended Offset	26815	2.375" Offset, 6000 Series
	26885	4.00" Offset, 6000 Series
	27200	3.10" Offset, 7000 Series
	26890	4.00" Offset, 7000 Series
	25274	3.35" Offset, 8000 Series
	25275	4.00" Offset, 8000 Series
	26840	3.35" Offset, 9000 Series
30306	5.00" Offset, X Series	
31273	5.00" Offset, Y Series	
 Double Ended Flat	26830	6000 Series
	26820	7000 Series
	25278	8000 Series
 Double Ended Offset	25276	3.35" Offset, 8000 Series

## HEAVY DUTY WATER-RESISTANT CASE FOR HT TOOLS



Case with molded foam insert

Made of ultra high-strength polypropylene copolymer resin, this water resistant utility case protects AcraDyne HT tools.

- Molded-in hinge, trigger-release latch system, and snap-down cushion grip handle
- Resistance to UV, solvents, corrosion, and impact damage

## PROTECTIVE COVERS

Durable protective covers prevent marring and damage.



Model	Description
BJ10078	Protective Cover, 6000 Series
BJ10077	Protective Cover, 7000 Series
BJ10076	Protective Cover, 8000 Series

Model	Compatible Tools	Description
CC-6000-F	6000 series	Case with molded foam insert
CC-6000-FIP	6000 series	Case with foam in place
CC-7000-F	7000 series	Case with molded foam insert
CC-7000-FIP	7000 series	Case with foam in place
CC-8000-F	8000 series	Case with molded foam insert
CC-8000-FIP	8000 series	Case with foam in place

Please contact an AIMCO Customer Service Associate for details, 1-503-254-6600, or toll free 1-800-852-1368.

# DC Tools: Tool/Spindle Selection Guide

Model	RPM**	Length		Weight		Torque, Nm																						
		IN	MM	LB	KG	5	10	15	20	25	50	75	100	125	150	175	200	225	250	275	300	325	350	375	400	425	450	
<b>Angle</b>																												
AEN4C12004B	3,111	11.65	295.9	2.0	0.91	█																						
AEN4C12009B	1,750	11.00	279.5	2.2	1.00	█	█																					
AEN4C12014B	875	11.66	296.4	2.2	1.00	█	█	█																				
AEN4C12018B	691	11.66	296.4	2.2	1.00	█	█	█	█																			
AEN4C12022B	560	11.66	296.4	2.2	1.00	█	█	█	█	█																		
AEN32015C	1,481	14.6	371.0	2.7	1.22		█	█																				
AEN32025C	833	14.6	371.0	2.7	1.22		█	█	█																			
AEN32030C	803	14.4	366.2	2.8	1.27		█	█	█	█																		
AEN32040C	574	14.4	366.2	2.8	1.27		█	█	█	█	█																	
AEN33042C	1,095	16.6	422.3	4.4	2.00			█	█	█																		
AEN33053C	1,095	16.6	422.3	4.4	2.00			█	█	█	█																	
AEN33060C	845	18.9	480.5	6.6	2.99				█	█	█	█																
AEN33090C	568	18.9	480.5	6.6	2.99					█	█	█	█															
AEN33120C	442	21.0	533.5	9.3	4.22						█	█	█	█														
AEN33200C	245	23.2	589.6	9.4	4.26							█	█	█	█	█												
AEN33210C	234	23.6	599.9	10.0	4.54								█	█	█	█	█											
AEN33300C	151	23.6	599.0	10.0	4.54									█	█	█	█	█	█									
AEN33375C	151	23.6	599.0	10.0	4.54										█	█	█	█	█	█	█							
AEN35090B	607	22.6	573.7	6.9	3.13											█	█	█	█	█								
AEN35140B	472	22.5	571.9	10.4	4.72												█	█	█	█	█							
AEN35175B	384	22.5	571.9	10.5	4.76													█	█	█	█	█						
AEN35225B	291	22.9	581.1	12.3	5.58														█	█	█	█	█					
AEN35285B	236	22.9	581.1	12.3	5.58															█	█	█	█	█				
AEN35350B	191	22.9	581.1	12.3	5.58																█	█	█	█	█			
<b>Inline</b>																												
AES4A12003BQ	2,625	11.12	282.7	2.0	0.91	█																						
AES4A12006BQ	2,625	11.12	282.7	2.0	0.91	█	█																					
AES4A12011BV	1,313	11.44	290.5	2.2	1.00	█	█	█																				
AES4A12014BV	1,037	11.44	290.5	2.2	1.00	█	█	█	█																			
AES4A12018BV	840	11.44	290.5	2.2	1.00	█	█	█	█	█																		
AES4A12022BV	656	11.44	290.5	2.2	1.00	█	█	█	█	█	█																	
AES32010CV	2,222	13.9	351.7	2.5	1.13	█	█																					
AES32020CV	1,250	13.9	351.7	2.5	1.13	█	█	█																				
AES32025CV	893	13.9	351.7	3.2	1.45	█	█	█	█																			
AES32038CV	595	16.7	424.0	4.2	1.91	█	█	█	█	█																		
AES33040CV	1,314	18.2	463.4	6.4	2.90	█	█	█	█	█	█																	
AES33060CV	883	18.2	463.4	6.4	2.90	█	█	█	█	█	█	█																
AES33100CV	489	22.6	573.0	8.1	3.67	█	█	█	█	█	█	█																
AES33150CV	329	22.6	573.0	8.1	3.67	█	█	█	█	█	█	█	█															
AES33230CV	221	22.6	573.0	8.1	3.67	█	█	█	█	█	█	█	█	█														
AES33230C-2	221	22.6	573.0	8.1	3.67	█	█	█	█	█	█	█	█	█	█													
AES33400CV	122	24.9	632.5	13.0*	5.90*	█	█	█	█	█	█	█	█	█	█	█	█	█	█	█	█	█	█	█	█	█	█	█
AES33600CV**	82	24.9	632.5	13.0*	5.90*	█	█	█	█	█	█	█	█	█	█	█	█	█	█	█	█	█	█	█	█	█	█	█
AES35075AV	944	21.9	555.2	9.2	4.17																							
AES35090AV	767	21.9	555.2	9.2	4.17																							
AES35110AV	634	21.9	555.2	9.2	4.17																							
AES35135AV	515	21.9	555.2	9.2	4.17																							
AES35170AV	418	21.9	555.2	9.2	4.17																							
AES35280A	236	24.2	615.1	12.8	5.81																							
AES35350A	192	24.2	615.1	12.8	5.81																							
AES35420A	159	24.2	615.1	12.8	5.81																							
AES35515A****	129	24.2	615.1	12.8	5.81																							
AES35635A****	104	24.2	615.1	12.8	5.81																							

Recommended Torque Range

\* Includes reaction bar and fixture nut.  
 \*\* Torque Range: 120-480 Nm Max Torque: 600 Nm  
 \*\*\* Torque Range: 128-515 Nm  
 \*\*\*\* Torque Range: 159-635 Nm

Continued on next page

# DC Tools: Tool/Spindle Selection Guide

Model	RPM**	Length		Weight		Torque, Nm																						
		IN	MM	LB	KG	5	10	15	20	25	50	75	100	125	150	175	200	225	250	275	300	325	350	375	400	425	450	
<b>Pistol</b>																												
AEP4_12003B_	2,625	7.3	186.3	2.2	1.00																							
AEP4_12006B_	2,625	7.3	186.3	2.2	1.00																							
AEP4_12011BV	1,313	8.0	203.3	2.3	1.04																							
AEP4_12014BV	1,037	8.0	203.3	2.3	1.04																							
AEP4_12018BV	840	8.0	203.3	2.3	1.04																							
AEP4_12022BV	656	8.0	203.3	2.3	1.04																							
AEP4_22020BV	1,313	8.7	219.9	2.4	1.09																							
AEP4_22025BV	1,037	8.7	219.9	2.4	1.09																							
AEP4_22030BV	840	8.7	219.9	2.4	1.09																							
AEP4_22035BV	747	8.7	219.9	2.4	1.09																							
AEP4_22040BV	656	8.7	219.9	2.4	1.09																							
AEP35075AV	944	16.0	405.2	9.2	4.17																							
AEP35090AV	767	16.0	405.2	9.2	4.17																							
AEP35110AV	634	16.0	405.2	9.2	4.17																							
AEP35135AV	515	16.0	405.2	9.2	4.17																							
AEP35170AV	418	16.0	405.2	9.2	4.17																							
AEP35280A	236	18.4	468.2	13.6	6.17																							
AEP35350A	192	18.4	468.2	13.6	6.17																							
AEP35420A	159	18.4	468.2	13.6	6.17																							
AEP35515A*	129	18.4	468.2	13.6	6.17																							
AEP35635A**	104	18.4	468.2	13.6	6.17																							
<b>TubeNut</b>																												
AET4A12018B	516	15.4	288.1	3.1	1.41																							
AET4A12025B	387	15.4	288.1	3.1	1.41																							
AET4A12025B-KD	387	15.9	404.9	3.1	1.41																							
AET32020C	622	17.2	436.4	3.1	1.41																							
AET32025C	466	17.8	450.9	4.0	1.81																							
AET32035C	347	18.1	460.5	4.5	2.04																							
AET32050C	257	18.8	478.0	5.6	2.54																							

\* Torque Range: 128 - 515 Nm  
 \*\* Torque Range: 159 - 635 Nm

Recommended Torque Range



## High Torque Series

Model Number Ending In	RPM**	Length		Weight		Torque, Nm																						
		IN	MM	LB	KG	50	100	200	300	400	500	600	850	1100	1200	1300	1500	2000	2500	3000	4000	5000	6500	8100	12000	17000		
66250B (DL)	315	12.4 - 24.8	314 - 630	9 - 12	3.9 - 5.3																							
66425B (DL)	165	12.4 - 24.8	314 - 630	9 - 12	3.9 - 5.3																							
66625B (DL)	106	12.4 - 24.8	314 - 630	9 - 12	4.1 - 5.5																							
66925B (DL)	72	12.4 - 24.8	314 - 630	9 - 12	4.1 - 5.5																							
771000B (DL)	65	12.7 - 19.4	324 - 492	13 - 16	5.9 - 7.3																							
771800BDL	28	18.7	475	7.5	16.5																							
772500B (DL)	25	14.1 - 20.8	359 - 528	15 - 18	6.8 - 8.2																							
872800B	9	16 - 17	406 - 430	22	10																							
884200B1 (DL)	12	410 - 446	16.1 - 17.6	23 - 26	10.4 - 11.8																							
884200B (DL)	12	410 - 446	16.1 - 17.6	24.5	11.1																							
885000B1	4.5	16.6 - 17.6	422 - 446	26	11.8																							
885000B	4.5	16.6 - 17.6	422 - 446	26	11.8																							
885000BDL	9.3	16.1	410	23	10.4																							
896500B (DL)	5 - 7	17.2 - 19.7	438 - 499	33 - 36	15 - 16.4																							
898100B (DL)	5	18.2 - 20.9	462 - 532	33 - 36	15 - 16.4																							
996500B	5.8	19.5	494	42	19																							
998100B (DL)	2.3	21.4	544	48	21.8																							
9X12000B (DL)	2	17.4 - 22.5	441 - 572	70	31.8																							
9Y17000B (DL)	1	15 - 18	381 - 458	94	42.6																							

Recommended Torque Range

# AcraDyne Accessories

## CABLE ASSEMBLIES

The AcraDyne DC electric nutrunner tool system uses a single cable to carry all necessary conductors for superior ergonomics and durability.

- Flexible polyurethane cover for maximum durability, abrasion and transmission fluid resistant
- Quick disconnects at both ends facilitate tool changeover and troubleshooting
- The CAN data/signal is via RJ45 for products such as the KDM socket tray or computer

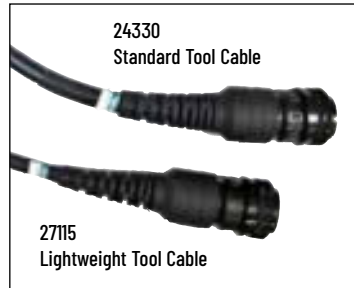

Model	Description	Length	
		M	Ft
<b>Tool Cables</b>			
24330	G3/G4 Tool Cable 3M	3	9.8
25350	G3/G4 Tool Cable 5M	5	16.4
24320	G3/G4 Tool Cable 10M	10	32.8
27110	G3/G4 Tool Cable 3M Lightweight*	3	9.8
27115	G3/G4 Tool Cable 5M Lightweight*	5	16.4
27122	G3/G4 Tool Cable 10M Lightweight*	10	32.8
<b>Extensions</b>			
24320	Extension cable 10M	10	32.8
25518	Extension cable 20M	20	65.6

\*Lightweight cables are for use only with 1000 & 2000 Series tools.

## CABLE ADAPTERS AND CONNECTORS

Model	Description
<b>Adapters and Connectors</b>	
	26364 G3/G4 Right Angle Cable Adapter
	25491 G3/G4 Breakaway Cable Connector - Ensures disconnect of cable should stress in excess of 40 lbs. occur (see below)
	30355 Y Cable Harness connects G4 iAC controller and controller's I/O to tool's EC/ MCCBL cable. Compatible with UA-40S(D) MC, UA-50S(D)MC, UA-60S(D)MC, UA-70SMC, and UA-150MC tools.

## DATA INTERFACE OPTION

Model	Description
<b>Data Interface Options</b>	
	27348 I/O Wiring Connector - Simple module to facilitate connections to I/O on iEC Controllers
	28292 System Port Cable, USB 2.0 Cable, A Male to B Male, 3M

## BREAKAWAY CABLE CONNECTOR

Innovative Quick Disconnect Device reduces cable damage from dropping tools or pulling cables when in use.

- Easily snaps into place, using magnetic force, at either the tool or the controller
- Adjust holding force by removing or adding magnets. Max holding force is 40 lbs / 18 kg

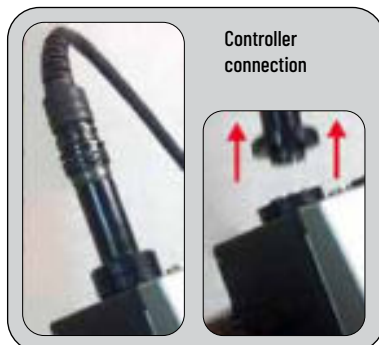

## LIGHT TOWER



Cost- and energy-efficient LED light tower is visible from any direction, angle, and distance

- Two built-in alarms (FB Type) with selectable sound patterns
- Adjustable Volume (Max. 85 dB at 1 m)
- Tower includes red, yellow, green, blue, and clear lenses





# AcraDyne Accessories

## FRL ASSEMBLY KIT

For use with the iAC controller, AcraDyne's FRL assembly kit includes a regulator and solenoid. The kit attaches to the controller or can operate as a stand-alone unit.



Top view



30850 FRL Assembly Kit

## ANGLE TOOL BODY JACKETS

Keep tools protected with AIMCO's tool Body Jackets.



Model	Description
BJ10051	For 1000 series angle tools
BJ10052	For 2015, 2025 series angle tools
BJ10053	For 2030, 2040, 2055 series angle tools
BJ10054	For 3060, 3090 series angle tools
BJ10055	For 3120, 3200 series angle tools

## SOCKET TRAYS

Socket trays, for use with iEC and UEC Controllers, are supplied with blank socket pucks machined to fit specific sockets for the application. AIMCO provides this machining as an additional service. When ordering, please specify the outer dimensions of the sockets you plan to use, and whether you would like a quote for the machining service.

- Simply remove the assigned socket to select the application to be run
- Quick and easy set up. Parameters assigned to socket position automatically
- Optional self-illuminating socket receptacles
- Delrin® blanks may be easily machined by the customer to accommodate custom socket profiling
- Nothing to break, wear out, or maintain
- Proximity sensors detect presence of socket



Model	Description
AMPST-2-I	2-Position Socket Tray for iEC Controllers, 2 x 1, 1.25" Socket
AMPST-2-U	2-Position Socket Tray for UEC Controllers, 2 x 1, 1.25" Socket
AMPST-4-I	4-Position Socket Tray for iEC Controllers, 2 x 2, 1.25" Socket
AMPST-4-U	4-Position Socket Tray for UEC Controllers, 2 x 2, 1.25" Socket
AMPST-6S-I	6-Position Socket Tray for iEC Controllers, 6 x 1, 1.25" Socket
AMPST-6S-U	6-Position Socket Tray for UEC Controllers, 6 x 1, 1.25" Socket
AMPST-6-I	6-Position Socket Tray for iEC Controllers, 3 x 2, 1.25" Socket
AMPST-6-U	6-Position Socket Tray for UEC Controllers, 3 x 2, 1.25" Socket
AMPST-8-I	8-Position Socket Tray for iEC Controllers, 4 x 2, 1.25" Socket
AMPST-8-IL	8-Position Socket Tray for iEC Controllers, 4 x 2, 2.0" Socket
AMPST-8-U	8-Position Socket Tray for UEC Controllers, 4 x 2, 1.25" Socket

Socket trays with 6 - 8 positions are available in varied configurations to suit workspace requirements (straight or double rows). Tell your AIMCO representative your specific requirements when inquiring.

## BAR CODE SCANNER

Sturdy bar code scanners allow you to easily scan small, stacked, or poorly printed, one-dimensional bar codes. Kit includes a cradle, power supply, and USB/Ethernet cable.



28859  
Bluetooth®-Enabled  
Scanner Kit

- Scratch proof, tempered glass exit window
- Single-circuit board construction eliminates common interconnection failures
- Industrial long-life charging contacts can withstand 250,000+ insertions into cradle
- Wireless scanner enables users to hold scanner at any angle

Model	Description
20400	RS232 Barcode Reader Kit
28859	RS232 Wireless Barcode Reader Kit

# AcraDyne Accessories

## CONTROLLER BRACKETS

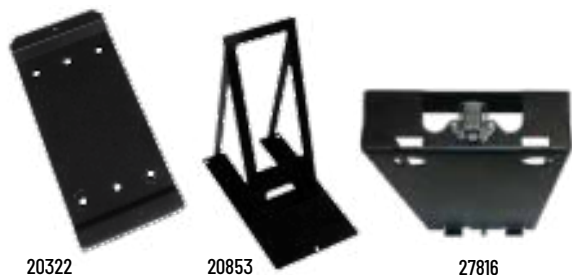

Model	Description
20322	Basic wall-mounting plate
20853	Table stand free standing platform
27816	Mounting bracket with internal wireways

## TOOL BAILS

- AcraDyne's spring bails are designed for use with any of the AcraDyne 1000, 2000, or 3000 Series tools
- Spring bails snap on quickly and firmly at any place on the body of the tool for perfect balance and secure suspension

Model	Description
25501	Wire Bail for 1000 Series Tools
27594	Stationary Bail for 1000 Series Tools
27791	Rotating Bail Assembly for 1000 Series Tools
26568	Cable Bail to Hang Tool Vertically for Gen III Cables
21208	Spring Bail for 2000 Series Tools
23662	Rotating Bail for 2000 Series Tools
28475	Rotating Bail for AEN33042C and AEN33053C
23575	Rotating Bail for 3000 Series Tools

## MOUNTING BRACKETS

Model	Description
25717	Mounting Bracket for 1000 Series Angle Tools
25843	Mounting Bracket for 1000 Series Push-To-Start Tools
26443	Mounting Bracket for 1000/2000 Series Straight and Pistol Tools
24824	Mounting Flange for 1000/2000 Series Straight and Pistol Tools
28622	Mounting Flange for 2000 Series Inline Tools
30340	Mounting Bracket for 2000 Series Angle Tools
30351	Mounting Bracket, Drive End for 2000 Series Inline Tools
25718	Mounting Bracket for 3000/5000 Series Angle Tools
26570	Mounting Bracket for 3000/5000 Series Straight Tools
25265	Angle head Mounting Bracket (Cradle type) for 3000/5000 Angle Tools over 225 Nm
26394	Mounting Flange for 5000 Series

## TOOL STORAGE

Tool baskets and tool hangers are a great way to keep a tool in place when not being used.

### UNIVERSAL TOOL BASKET

Interchangeable among angle head and pistol grip tool models throughout the industry.

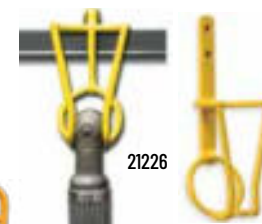

### VERTICAL TOOL HANGER

Designed for AcraDyne Gen 1/Gen 2 tools.

# AcraDyne Cordless AB Series

## AcraDyne Cordless AB Series INNOVATIVE TOOLS IN A POWERFUL PACKAGE

AcraDyne's high-performance cordless tools deliver precise torque and/or angle to the fastener. Innovative technology guarantees repeatable torque results every time, ensuring you meet your most important goal – creating quality products. The tools are available in two model types:



### FEATURES AND BENEFITS OF ALL AB TOOLS

- Self-Controlling Tools  
Can run stand alone or in conjunction with an iBC ACE Platform controller as a line interface (see page 12)
- Tool programming done with no-cost AcraDyne Tool Manager software using USB cable interface to PC
- Selectable vibration alarm provides tactile feedback
- 99 programs with 6 steps per program available
- Job functionality for sequencing and/or bolt counting
- Programmable
  - Torque
  - Angle
  - RPM
  - Time
  - Fastening direction
- Multicolor LED status screen
- 150,000 results stored on-board

### TORQUE RANGES

#### AB-MTA

- Pistol Tool: 1.0 – 17 Nm
- Straight Tool: 1.0 – 17 Nm
- Angle Tool: 2.5 – 115 Nm

#### AB-CTA

- Pistol Tool: 1.5 – 3,000 Nm (torque range for pistol tools includes Ultra Torque models on page 54)
- Straight Tool: 1.5 – 17 Nm
- Angle Tool: 1.5 – 120 Nm
- Tubenut Tool: 3.0 – 20 Nm

# AcraDyne Cordless AB Series



## MTA Series

Measures Torque and Reports Angle

The AB-MTA Series controls torque to the fastener with a precision Clutch Shut-Off mechanism. This technology increases productivity by allowing the tool to run at higher speeds and with minimal overshoot. The highly accurate clutch reduces torque reaction transmitted to the operator through its speed of shut-off at the moment reaction forces are generated.



For simple adjustment, the MTA series provides easy clutch access.



### AcraDyne Cordless AB-MTA Series Tools

Model	Torque Range		Max Speed RPM	Drive Type	Weight W/O Battery		Tool Dimensions							
	NM	FT-LB			KG	LB	A		B		C		D	
							IN	MM	IN	MM	IN	MM	IN	MM
<b>Pistol</b>														
ABP-MTA06(Q)(WQ)(BQ)(WBQ)	1.0 - 6	0.8 - 4.4	1,100	1/4" QC	1.25	2.75	9.1	230	1.02	26	8.56	218	4.5	115
ABP-MTA08(Q)(WQ)(BQ)(WBQ)	1.5 - 8	1.1 - 5.9	880	1/4" QC	1.25	2.75	9.1	230	1.02	26	8.56	218	4.5	115
ABP-MTA12(Q)(WQ)(BQ)(WBQ)	2.3 - 12	1.7 - 8.9	629	1/4" QC	1.25	2.75	9.1	230	1.02	26	8.56	218	4.5	115
ABP-MTA17(Q)(WQ)(BQ)(WBQ)	3.5 - 17	2.6 - 12.5	449	1/4" QC	1.25	2.75	9.1	230	1.02	26	8.56	218	4.5	115
<b>Straight</b>														
ABS-MTA06(Q)(WQ)(BQ)(WBQ)	1.0 - 6	0.8 - 4.4	1,100	1/4" QC	1.0	2.2	17.2	437	3.19	81	0.79	20	4.5	115
ABS-MTA08(Q)(WQ)(BQ)(WBQ)	1.5 - 8	1.1 - 5.9	880	1/4" QC	1.0	2.2	17.2	437	3.19	81	0.79	20	4.5	115
ABS-MTA12(Q)(WQ)(BQ)(WBQ)	2.3 - 12	1.7 - 8.9	629	1/4" QC	1.1	2.4	17.2	437	3.19	81	0.79	20	4.5	115
ABS-MTA17(Q)(WQ)(BQ)(WBQ)	3.5 - 17	2.6 - 12.5	449	1/4" QC	1.25	2.75	17.2	437	3.2	81	0.8	20	4.5	115
<b>Angle</b>														
ABN-MTA10(W)(B)(WB)	2.5 - 10	1.9 - 7.4	629	3/8" Sq.	1.35	3.0	17.9	455	3.94	100	1.12	29	4.5	115
ABN-MTA17(W)(B)(WB)	3.5 - 17	2.6 - 12.5	420	3/8" Sq.	1.4	3.1	18.1	461	4.14	105	1.29	33	4.5	115
ABN-MTA24(W)(B)(WB)	5 - 24	3.7 - 17.7	300	3/8" Sq.	1.4	3.1	18.1	461	4.14	105	1.29	33	4.5	115
ABN-MTA55(W)(B)(WB)	13 - 55	9.6 - 40.6	94	3/8" Sq.	2.7	6.0	22.5	572	7.7	196	1.65	42	4.5	115
ABN-MTA90(W)(B)(WB)	9.6 - 90	13.3 - 66.4	70	3/8" Sq.	2.9	6.4	25.9	658	10.2	259	1.8	46	4.5	115
ABN-MTA115(W)(B)(WB)	23 - 115	17 - 84.8	56	1/2" Sq.	3.1	6.8	28.4	721	13.9	353	2.8	71	4.5	115

W = Wifi option    B = Barcode option    Q = Quick Change

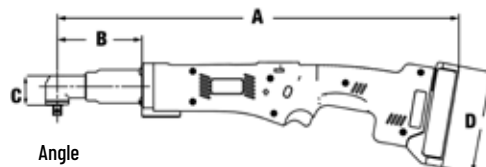
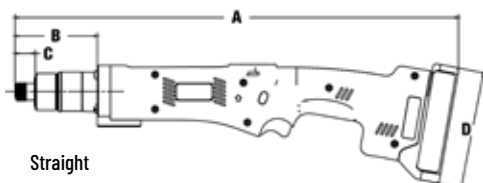
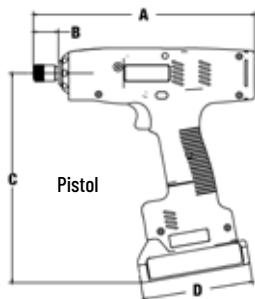

# AcraDyne Cordless AB Series



## CTA Series

Controls Torque and Angle

The AB-CTA Series provides the most sophisticated option in the AcraDyne cordless tool line. The Transducer Shut-Off means precise torque measurement with high accuracy and traceable results. Transducer shut-off allows speed adjustment and provides the ability to reject conditions such as cross threads and double hits on a fastener.



### AcraDyne Cordless AB-CTA Series Tools

Model	Torque Range		Max Speed RPM	Drive TYPE	Weight W/O Battery		Tool Dimensions									
	NM	FT-LB			KG	LB	A		B		C		D		E	
							IN	MM	IN	MM	IN	MM	IN	MM	IN	MM
<b>Pistol</b>																
ABP-CTA12(O)(WQ)(BQ)(WBQ)	1.5 - 12	1.1 - 8.9	629	1/4" QC	1.15	2.5	9.1	230	1.02	26	8.56	218	4.5	115	-	-
ABP-CTA17(O)(WQ)(BQ)(WBQ)	3 - 17	2.2 - 12.5	449	1/4" QC	1.15	2.5	9.1	230	1.02	26	8.56	218	4.5	115	-	-
For 120 – 5,000 Nm Pistol Tools, see Ultra Torque models on page 54																
<b>Straight</b>																
ABS-CTA12(O)(WQ)(BQ)(WBQ)	1.5 - 12	1.1 - 8.9	570	1/4" QC	0.95	2.1	17.2	437	3.19	81	0.79	20	4.5	115	-	-
ABS-CTA17(O)(WQ)(BQ)(WBQ)	3 - 17	2.2 - 12.5	460	1/4" QC	0.95	2.1	17.2	437	3.19	81	0.79	20	4.5	115	-	-
<b>Angle</b>																
ABN-CTA10(W)(B)(WB)	1.5 - 10	1.1 - 7.4	570	3/8" Sq.	1.35	3.0	17.9	455	3.94	100	1.12	29	4.5	115	-	-
ABN-CTA17(W)(B)(WB)	2.5 - 17	1.8 - 12.5	380	3/8" Sq.	1.4	3.1	18.1	461	4.14	105	1.29	33	4.5	115	-	-
ABN-CTA24(W)(B)(WB)	5 - 24	3.7 - 17.7	300	3/8" Sq.	1.2	2.6	18.1	461	4.14	105	1.29	33	4.5	115	-	-
ABN-CTA36(W)(B)(WB)	8 - 36	5.9 - 26.6	170	3/8" Sq.	1.2	2.6	21.6	547	7	179	1.65	42	4.5	115	-	-
ABN-CTA55(W)(B)(WB)	15 - 55	11.1 - 40.6	90	3/8" Sq.	1.4	3.1	23.1	587	8.61	219	1.65	42	4.5	115	-	-
ABN-CTA90(W)(B)(WB)	25 - 90	18.4 - 66.6	60	1/2" Sq.	2.9	6.4	25.9	658	11.4	290	1.91	49	4.5	115	-	-
ABN-CTA120(W)(B)(WB)	35 - 120	25.8 - 88.5	50	1/2" Sq.	3.1	6.8	28.4	720	13.9	352	2.81	71	4.5	115	-	-
<b>Tubnut</b>																
ABT-CTA15W	3 - 15	2.2 - 11.1	400	1/4" - 7/16" hex	1.2	2.6	22.2	565	7.82	199	4.17	106	4.5	115	0.5	12.7
ABT-CTA24W	6 - 24	4.4 - 17.7	300	3/8" - 5/8" hex.	1.2	2.6	22.9	582	8.39	213	4.74	121	4.5	115	0.56	14

W = WiFi option    B = Barcode option    Q = Quick Change

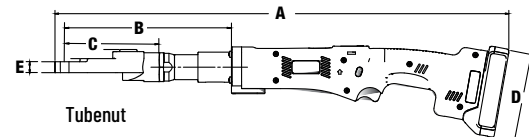
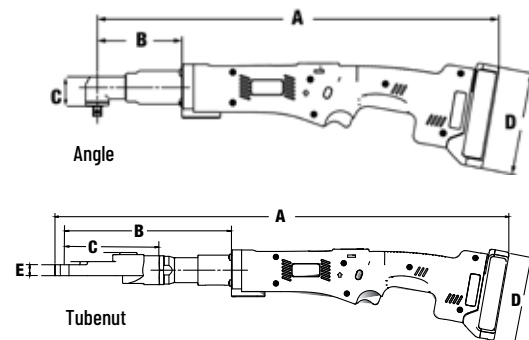
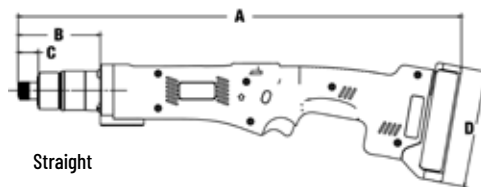
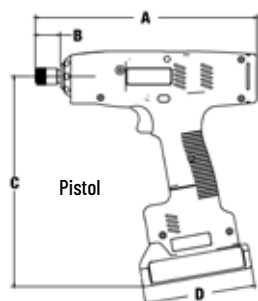

# AcraDyne Cordless ABP Ultra Torque Nutrunners

## Ultra Torque ABP-CTA Series

Unmatched Accuracy for Higher-Torque Applications

### FEATURES AND BENEFITS

- Transducerized for precise delivery of torque and angle to the fastener
- Usable stand-alone or with AcraDyne iBC series Controller for line controls and/or data integration with QMS systems
- Sophisticated control set with AcraDyne Tool Manager program with 99 PSETS available
- Operator feedback with OLED screen, audible and tactile feedback
- Wide variety of strategies
  - Torque
  - Angle
  - Torque Plus Turn
  - Torque Minus Turn
  - And more...
- Available with Two-Hand, No Tie Down Button to ensure operator safety from accidental contact with reaction bar
- Standard Offset, Deep Offset, and Flat Reaction Bars available. Custom reaction bars available by request
- Tool supplied with one battery (P/N AB-B1850LI), see page 55 and standard reaction bar. Charger (see page 55) is purchased separately:
  - AB-C18110 (120VAC) Charger or
  - AB-C18220 (220VAC) Charger

**AcraDyne**® **ULTRA TORQUE**



### AcraDyne Cordless ABP-CTA Ultra Torque Series Tools

Model	Max Torque		Max Speed RPM	Length		Weight	Gearbox Diameter	
	NM	FT-LB		MM	IN		MM	IN
ABP-CTA120W	120	89	68	335	13.2	w/out battery: 3.7 kg / 8.04 lb w/battery: 4.3 kg / 9.44 lb	67	2.6
ABP-CTA250W	250	185	27	335	13.2	w/out battery: 3.7 kg / 8.04 lb w/battery: 4.3 kg / 9.44 lb	67	2.6
ABP-CTA450W	450	332	14	335	13.2	w/out battery: 3.7 kg / 8.04 lb w/battery: 4.3 kg / 9.44 lb	67	2.6
ABP-CTA650W	650	480	9.4	335	13.2	w/out battery: 3.7 kg / 8.04 lb w/battery: 4.3 kg / 9.44 lb	67	2.6
ABP-CTA950(W)	950	700	6.4	335	13.2	w/out battery: 3.7 kg / 8.04 lb w/battery: 4.3 kg / 9.44 lb	67	2.6
ABP-CTA1400W	1,400	1,000	4	338	13.3	w/out battery: 4.0 kg / 8.85 lb w/battery: 5.1 kg / 11.25 lb	77.5	3.1
ABP-CTA3000W	3,000	2,200	2.1	374	14.7	w/out battery: 5.6 kg / 12.31 lb w/battery: 6.2 kg / 13.71 lb	77.5	3.1
ABP-CTA5000W	5,000	3,688	1.3	418	16.5	w/out battery: 7.9 kg / 17.4 lb w/battery: 8.5 / 18.8 lb	91.2	3.6

W = WiFi



AB-B1850LI Battery

AB-C18110 Battery Charger



## Batteries & Chargers

### BATTERIES

- Li-Ion for best energy density
- Deep-discharge protection prevents battery failure
- All AB models utilize the same battery connection and chargers
- Batteries available in 2.5 Ah or 5.5 Ah



AB-B1825LI



AB-B1850LI

Battery Model #	Voltage	Type	Capacity	Weight
AB-B1825LI	18V	Li-Ion	2.5 Ah	.8 Lb/.35 kg
AB-B1850LI	18V	Li-Ion	5.0 Ah	1.3 Lb/.6 kg



AB-C18110

### BATTERY CHARGERS

- Battery defect detection
- Microprocessor-controlled charging: Charging time is dependent on the capacity of the battery
- Reverse polarity protection
- Automatic battery voltage detection
- Multi-bay charger includes battery adapters
- All AB models use the same batteries and chargers



AB-C18-4W

Model	Description	Output	Input	Charging Time	Dimensions (W/O Battery)	Weight
AB-C18110	Quick-charge unit for 110V	14.4V - 18V, 3.0A	110VAC, 50-60Hz	Max 55 min for 2.5 Ah battery	3.39" (W) x 4.21" (H) x 6.02" (D) 86 mm (W) x 107 mm (H) x 153 mm (D)	1.2 Lb/.55 kg
AB-C18220	Quick-charge unit for 220V	14.4V - 18V, 3.0A	220-240VAC, 50-60Hz	Max 55 min for 2.5 Ah battery	3.39" (W) x 4.21" (H) x 6.02" (D) 86 mm (W) x 107 mm (H) x 153 mm (D)	1.2 Lb/.55 kg
AB-C18-4W	4-bay charge unit for 100-240VAC	14.4V - 18V, 3.0A	100-240VAC, 50-60Hz	Max 55 min for 2.5 Ah battery	21.2" (W) x 7.2" (H) x 10.2" (D) (incl. feet) 539 mm (W) x 182 mm (H) x 260 mm (D) (incl. feet)	16.8 Lb/7.6 kg



AB-PCOLRING

### COLOR INDEX RINGS

Colored rings on AB Series tools make it easy to determine tool torque with a quick glance. Set comes with four colors: blue, yellow, red, and silver.

### SUSPENSION BAIL

Bails attach to tool body for perfect balance and secure suspension.



AB-PBAIL



## **MULTIPLE NUTRUNNING SYSTEMS**

AIMCO can integrate the AcraDyne tool spindle into a customized Multiple Nutrunner system. From simple systems vertically suspended above the part, to assembly stations that integrate with your line, AIMCO can effectively accommodate your project.

**LET US KNOW YOUR REQUIREMENTS AND WE WILL PROPOSE A SOLUTION TAILORED TO YOUR NEEDS.**



## **FEATURES AND BENEFITS**

- Nutrunner sequencing - Allows nutrunners to be sequenced at each phase of the tightening process, providing even distribution of torque and load to each fastener. This prevents part damage and distortion
- Snug threshold, final torque in one pass - No need for multiple torque stage sequencing. Fixtured nutrunners save time and effort
- No missed fasteners - Multiple nutrunners have a spindle dedicated to each location, ensuring quality on every rundown on every bolt
- Better residual torques - Synchronized controlled fastening allows residual torque levels to be consistent with the dynamic torque specification
- Saving in cycle time - Compared to using a single nutrunner tool with many rundowns, running all fasteners simultaneously reduces in-station cycle time
- Cost saving benefits - Saving installation cycle time frees operators to handle additional tasks and potentially reduce labor costs
- Collect data – Most common methods of collecting data for quality control and statistical analysis can be implemented from a serial data string using RS232 to formatted data from a network database

## **INDUSTRY APPLICATIONS**

- Harvester chain-pull assembly, 2-spindle
- Engine flywheel assembly, 3-spindle
- Wheel lug nut assembly, 4-spindle
- Axle u-bolt assembly, 4-spindle
- Gasoline generator assembly, 6-spindle
- Lawn mower motor assembly, 7-spindle
- Air-cooled small vehicle engine assembly, 10-spindle



# Tool Specials



AIMCO can provide customized tooling solutions for even the most unique applications. Let us propose a solution tailored to your needs. Contact an AIMCO Customer Service Associate for more details, 1-503-254-6600, or toll free 1-800-852-1368.



# Uryu Controlled Pneumatic Pulse Tools

## Uryu Controlled Pulse Tools Offer Ergonomic Solutions for Precise Quality Control and High Productivity

### MAGNETOSTRICTIVE TRANSDUCER

Uryu's unique feature, a brushless Magnetostrictive Transducer, provides real time monitoring of torque delivered to the fastener that is then used by the tool controller in managing the delivery of torque.

The Magnetostrictive Torque Transducer is a non-contact system consisting of the tool anvil surrounded by a pair of sensor coils providing accuracy and durability in a tightening process. This system is accurate and robust in detecting dynamic torque application while fastening.

When torque is applied to the tool anvil, tensile stress is detected by the coils as changes in the magnetic field. These magnetic field changes are analyzed and converted to torque signals that a controller uses to shut off the tool.

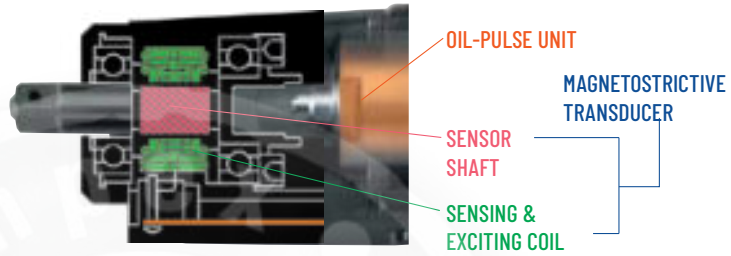

### AUTO RELIEF TECHNOLOGY

URYU's patented Auto Relief Technology ensures smooth delivery of torque during pulse tool operation.

A relief valve within the pulse unit manages the pressurization of the pulse unit fluid in a proportional manner. This modulation begins the application of torque energy to the fastener in a more controlled manner than has ever before been possible. A benefit of this technology is the elimination of an initial torque spike generated by the inertial mass of the pulse unit which, prior to bolt seating, is influenced by the inertia of the spinning mass.

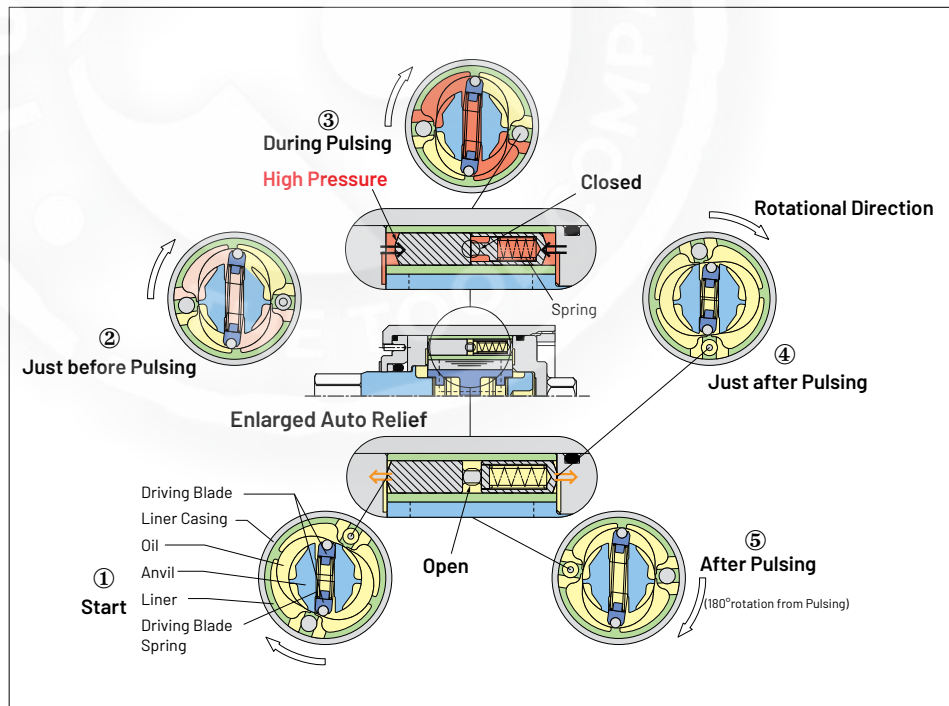

Uryu's Auto Relief system dynamically responds to the joint condition resulting in more pulses, shorter in duration to meet the target torque. This leads to more accurate fastening over a wide variety of application demands.

# Uryu Controlled Pneumatic Pulse Tools

## UA-MC PNEUMATIC PULSE SERIES



### FEATURES AND BENEFITS

- Auto Relief Technology provides additional torque control during pulsing events
- External solenoid valve increases power-to-weight ratio by 20%
- Magnetostrictive Transducer provides durability with low size and weight
- All models work with any UEC Series controller and can connect to a wide range of network protocols when used with an AcraDyne iAC series controller
- With torque reaction virtually non-existent, allowing for one-handed operation, the UA-MC provides significantly increased ergonomics

### CONTROLLER OPTIONS

 <p>URYU UEC-4801A Controller (see page 65)</p>	 <p>URYU UEC-5500 Controller for multiple spindles (see page 66)</p>	 <p>Gen IV iAC Controller for transducerized Uryu air tools (see page 11)</p>
---	---	--

### UA-MC Pneumatic Pulse Tools

Recommended air pressure: 85 PSI

Model	Torque Range		Free Speed RPM	Length MM	Length		Weight		Drive Size IN	Air Usage CFM
	NM	FT-LB			IN	LB	KG			
<b>Pistol Type</b>										
UA-40MC	6.8 - 12.0	5.0 - 8.8	3,600	170	6.7	2.4	1.1	3/8	7.0	
UA-40DMC	6.9 - 12.0	5.0 - 8.8	3,600	170	6.7	2.4	1.1	1/4 QC	7.0	
UA-50MC	16.6 - 29.0	12.2 - 21.4	4,250	170	6.7	2.4	1.1	3/8	8.8	
UA-50DMC	16.6 - 29.0	12.2 - 21.4	4,250	170	6.7	2.4	1.1	1/4	8.8	
UA-60MC	25.1 - 44.0	18.5 - 32.5	5,000	175	6.9	2.5	1.1	3/8	14.0	
UA-70MC	28.5 - 50.0	21.0 - 37.0	5,700	187	7.4	2.7	1.2	3/8	15.8	
UA-80MC	40.0 - 60.0	29.6 - 44.4	6,000	195	7.7	3.4	1.6	3/8	16.8	
UA-90MC	45.7 - 80.0	33.8 - 59.2	5,500	203	8.0	3.7	1.7	1/2	18.6	
UA-100MC	51.4 - 90.0	38.0 - 66.6	5,200	215	8.5	4.5	2.1	1/2	19.3	
UA-130MC	74.2 - 130.0	54.9 - 96.2	4,500	233	9.2	6.2	2.8	1/2	25.6	
UA-150MC	150 - 220	111 - 163	4,350	251	9.9	8.8	4.0	3/4	24.7	
<b>Straight Type</b>										
UA-40SMC	7.0 - 13.0	5.2 - 9.6	3,600	246	9.7	2.7	1.2	3/8	7.0	
UA-40SDMC	5.0 - 12.0	3.7 - 8.9	3,600	246	9.7	2.7	1.2	1/4	7.0	
UA-50SMC	11.0 - 25.0	8.1 - 18.5	4,250	246	9.7	2.7	1.2	3/8	8.8	
UA-50SDMC	9.0 - 23.0	6.7 - 17.0	4,250	246	9.7	2.7	1.2	1/4	8.8	
UA-60SMC	18.0 - 38.0	13.3 - 28.1	5,000	252	10.0	2.9	1.3	3/8	14.0	
UA-60SDMC	16.0 - 34.0	11.8 - 25.2	5,000	252	10.0	2.9	1.3	1/8	14.0	
UA-70SMC	30.0 - 50.0	22.2 - 37.0	5,700	265	10.4	3.1	1.4	3/8	15.8	

Air Inlet: 1/4" N.P.T.

Recommended Air Hose Size: 1/4" I.D. for UA-40MC - UA-50MC 3/8" I.D. for UA-60MC - UA-100MC 1/2" I.D. for UA-130MC - UA-150MC

\*  logo indicates where ERGO-DRIVE sockets/extensions benefit tool operation.

# Uryu Controlled Pneumatic Pulse Tools

## UA-AMC PNEUMATIC PULSE SERIES



UA-500AMC



UA-1300AMC

### FEATURES AND BENEFITS

- The UA-AMC features angle measurement for improved process control
- Virtually no torque reaction
- Detects cross threading, double hits on the same fastener, stripped and damaged fastener threads, and incorrect fasteners in an application
- Transducer integrated resolver
- Patented Auto Relief Technology provides smooth torque delivery during pulsing events
- Triple chamber air motors for high power output in UA-400AMC, UA-500AMC, and UA-600AMC models

### CONTROLLER OPTIONS



URYU UEC-4801A Controller (see page 65)



URYU UEC-5500 Controller for multiple spindles (see page 66)



Gen IV iAC Controller for transducerized Uryu air tools (see page 11)

### UA-AMC Pneumatic Pulse Tools

Recommended air pressure: 85 PSI

Model	Torque Range		Free Speed RPM	Length			Weight		Drive Size IN	Air Usage CFM
	NM	FT-LB		MM	IN	LB	KG			
UA-400AMC	7 - 13	5.2 - 9.6	3,600	193.0	7.6	3.0	1.4	3/8	7.0	
UA-500AMC	11 - 25	8.1 - 18.4	4,250	193.0	7.6	3.0	1.4	3/8	8.8	
UA-600AMC	18 - 38	13.3 - 28.0	5,000	198.5	7.8	3.1	1.4	3/8	14.0	
UA-700AMC	30 - 50	22.1 - 36.9	5,700	207.5	8.2	3.3	1.5	3/8	15.8	
UA-800AMC	40 - 60	29.5 - 44.3	5,300	215.5	8.5	3.7	1.7	3/8	16.8	
UA-900AMC	40 - 80	29.5 - 59.0	5,500	227.5	9.0	4.7	2.2	1/2	18.6	
UA-1000AMC	50 - 90	36.9 - 66.4	5,200	235.0	9.3	5.4	2.5	1/2	19.3	
UA-1300AMC	85 - 130	62.7 - 95.9	4,500	256.5	10.1	7.2	3.3	1/2	25.6	

Air Inlet: 1/4" N.P.T.

Recommended Air Hose Size: 1/4" I.D. for UA-400AMC - UA-500AMC 3/8" I.D. for UA-600AMC - UA-1000AMC 1/2" I.D. for UA-1300AMC

\* logo indicates where ERGO-DRIVE sockets/extensions benefit tool operation.

# Uryu Controlled Pneumatic Pulse & Electric Oil Pulse Tools

## ACRA-PULSE MC PNEUMATIC PULSE SERIES



UXR-1820MC



UXR-2400SMC

### FEATURES AND BENEFITS

- Electronically controlled built-in shut-off valve stops tool as soon as target torque is reached
- LED indicator shows Good or No Good after each tightening

### CONTROLLER OPTIONS



URYU UEC-4801A Controller  
(see page 65)



URYU UEC-5500  
Controller for multiple  
spindles (see page 66)



Gen IV iAC Controller for  
transducerized Uryu air tools  
(see page 11)

### UXR-MC Series Tools

Recommended air pressure: 85 PSI

Model	Torque Range		Free Speed RPM	Length		Weight		Drive IN	Noise Level dB(A)	Air Usage CFM
	NM	FT-LB		MM	IN	LB	KG			
Pistol										
UXR-1820MC	160 - 250	117.8 - 183.7	4,600	322	12.7	12.3	5.5	3/4 SQ.	84	24.7
UXR-2000MC	250 - 400	184.4 - 295.1	4,600	355	14	17.6	8.0	3/4 SQ.	85	33.6
Inline										
UXR-2400SMC	350 - 600	258.2 - 442.7	3,300	457	18.0	27.6	12.5	1.0 SQ.	85	35.3

\* External Solenoid Valve (909-749-0) Required

Air Hose Size: 3/8" I.D.

Air Inlet: N.P.T. 1/4"

N.P.T. 3/8" for UXR-1820MC

N.P.T. 1/2" for UXR-2400SMC

## UDP-MC TRANSDUCERIZED ELECTRIC PULSE SERIES



UDP-A600LMC



UDP-A700MC



UDP-A100MC  
UDP-A120MC

### FEATURES AND BENEFITS

- High speed for increased productivity
- Virtually no torque reaction
- Magnetostrictive Transducer provides durability with low size and weight
- Auto relief pulse mechanism for measured application of tightening energy
- Automatic Ventilation System: Cooling fan is activated automatically when pulling the throttle trigger, which reduces heat and increases duty cycle

### CONTROLLER OPTIONS



URYU UECP-4810 controller  
with integrated tool driver  
(see page 67)



Gen IV iPC Controller for  
transducerized Uryu DC pulse  
(see page 12)

### UDP-MC Series Tools

Model	Type	Torque Range		Free Speed RPM	Weight LB	Length IN	Drive IN	Sound Level dB(A)	Cable Assembly Connects Tool To Controller
		NM	FT-LB						
UDP-A600LMC	Transducerized	4 - 20	3 - 14.8	4,800	3.4	8.4	3/8 SQ.	74	910-807-0 (5 meter) 910-808-0 (10 meter)
UDP-A700MC	Transducerized	10 - 50	7.4 - 37	4,800	3.9	9.5	3/8 SQ.	76	
UDP-A100MC	Transducerized	45 - 100	33.3 - 74	4,800	6.3	9.8	1/2 SQ.	76	910-567-0 (5 meter) 910-568-0 (10 meter) 910-569-0 (15 meter) 910-625-0 (20 meter)
UDP-A120MC	Transducerized	55 - 120	40.5 - 88.4	4,800	6.3	9.8	1/2 SQ.	78	

\*  logo indicates where ERGO-DRIVE sockets/extensions benefit tool operation.

# REVOLUTIONARY

Quantum Leap Forward in Hydraulic Pulse Technology  
Coupled with a PRECISE Transducerized Battery Tool



Innovative Phoenix Pulse Unit with more efficient blades and elimination of springs **Lengthens Service Intervals** by as much as **400%** with a high degree of accuracy and a reaction-free operating experience

**Powerful & Intuitive Data Connectivity**

with Tool Controllers

**Increased Power**  
per Pulse

**Extremely Accurate**

Torque Control & Angle Monitoring

**Improved Operator Comfort**

with near Reaction-Free feel

**Fluid Cost Reduced**

by as much as 40%

#### CONTROLLER OPTIONS



URYU UCC-100Z controller with integrated tool driver (see page 68)



**AcraDyne** iBC-Z  
Gen IV iBC-Z Controller for transducerized UBX-AF series (see page 12)

# Uryu Controlled Battery Pulse Tools

## UBX-AFZ Series Shut-Off Battery Oil Pulse Tool

The UBX-AFZ series of Shut-Off Battery Oil Pulse Tools features Phoenix Pulse Tool technology design (patent pending) that houses fewer internal parts, lengthening fluid life and simplifying maintenance procedures.

### FEATURES AND BENEFITS

- On-board LED indicates fastening results
- Short duration, non-mechanical pulsing delivers torque to the fastener with near reaction-free feel
- Number of fastenings per minute (on average).  
Fastening time 0.5 sec.:
  - UBX-AF500Z: 11    – UBX-AF700Z: 9
  - UBX-AF600Z: 10    – UBX-AF900Z: 6
- Fastener quantity per full charge (on a B joint with 1 sec or less freerun):
  - UBX-AF500Z: 440
  - UBX-AF600Z & UBX-AF700Z: 320
  - UBX-AF900Z: 450
- Elliptical movement within pulse unit produces more power per pulse
- High pulse frequency and crisp tool shut off results in accurate delivery of torque
- Cycle times on most joints are reduced for more efficient production
- Fluid costs reduced by as much as 40% (using OEM recommended fluid)
- Clear & concise data connectivity when integrated with tool controllers



### UBX-AFZ Series Tools

Model*	Nominal Bolt Size		Torque**		Weight W/O Battery		Free Speed RPM	Length		Sq. Drive IN
	MM	IN	NM	FT-LB	KG	LB		MM	IN	
UBX-AF500Z	6 - 8	1/4 - 5/16	5 - 20	3.7 - 14.8	1.52	3.35	3,600	219	8.7	3/8
UBX-AF600Z	8 - 10	5/16 - 3/8	15 - 40	11.1 - 29.5	1.52	3.35	4,800	219	8.7	3/8
UBX-AF700Z	8 - 12	5/16 - 1/2	25 - 60	18.4 - 44.3	1.56	3.44	4,800	219	8.7	3/8
UBX-AF900Z	10 - 12	3/8 - 1/2	35 - 72	25.8 - 53	1.81	4.0	4,800	255	10	1/2

\* Base model comes with no battery. Batteries are available separately or in tool/kits combinations.

Add "B" to end of the model number to order 1 tool with 1 battery. Add "KIT" to the end of the model number to order a tool kit, which includes 1 tool, 2 batteries, and 1 battery charger.

\*\* Torque range varies depending on the battery size in use.

### UBX-AFZ Series Batteries and Battery Charger

Battery Model #**	Description	Voltage	Type	Capacity
EYFB32	Battery for UBX-AF500Z	10.8 V	Li-Ion	2.0Ah
EYFB41	Battery for UBX-AF600Z & UBX-AF700Z	14.4V	Li-Ion	2.0Ah
EYFB43B	Battery for UBX-AF600Z & UBX-AF700Z (available for additional cost)	14.4V	Li-Ion	4.0Ah
EYFB50	Battery for UBX-AF900Z	18V	Li-Ion	5.0Ah

\* 4.0Ah battery also available, Part #EYFB43B

Charger Model #	Description	Weight	Input Voltage	Dimensions	Battery Capacity
EY0L82B	Li-Ion battery charger	0.93 kg (2.0 lbs)	120VAC	9.3" D x 7.1" W x 3.6" H	3.0 - 4.2Ah



# Uryu Controllers

## STATE-OF-THE-ART CONTROLLERS FOR PULSE TOOLS

URYU UEC Controllers are available in several models, depending on the tool used and desired features:

- UEC-4801A: Compatible with UA-MC/SMC/AMC, and UXR-MC/SMC series. Single spindle control.
- UEC-4801A-ANGLE: Compatible with UA-MC/SMC/AMC, and UXR-MC/SMC series. Single spindle control with angle monitoring.
- UEC-5500: Multi-spindle capability, compatible with UA-MC/SMC/AMC and UXR-MC/SMC tools
- UECP-4810: Integrates UEC-4801A and Tool Driver. Compatible with UDP-MC tools only. Programmable from front panel or PC - no separate touchpad module or cable required
- UCC-100Z: Compatible with UBX-AF battery pulse series only



URYU UEC Controllers						
						
		UEC-4801A	UEC-4801A-ANGLE	UEC-5500	UECP-4810	UCC-100Z
		Single-Spindle Control	Single-Spindle Control with Angle Monitoring	Multi-Spindle Control	Integrated UEC-4801A Controller and Tool Driver for UDP Series Tools	Built-in Wireless unit for UBX-AF Series Tools
Tool Series						
UA-MC/SMC Series: Pneumatic Pulse Tools		X	X	X		
UA-AMC Series: Pneumatic Pulse Tool			X	X (with angle encoder board)		
UXR-MC/SMC Series: Pneumatic Pulse Tool		X		X		
UDP-MC Series: Electric Oil-Pulse Tool					X	
UBX-AF Series: Battery Pulse Tool						X



## UEC-4801A CONTROLLER



### UEC-4801A

#### FEATURES AND BENEFITS

- Low-cost LCD front panel
- 12,000 data point memory
- On-screen statistical readout. Statistical data can be graphed when connected to a PC. PC Windows-base software included.
- 16 parameter sets available
- Programmable I/O options
- Built-in Ethernet connectivity
- Can be used with Oil-Pulse Tools fitted with a Magnetostrictive Transducer: UA-MC/SMC/AMC series and UXR-MC/SMC Series
- Tracks cumulative fastening numbers and pulse numbers from the start of operation
- Highly reliable torque control and monitor
- MiniSD card slot on back panel allows you to save and read fastening and torque wave data
- UEC-4801A-ANGLE model includes angle monitoring capabilities

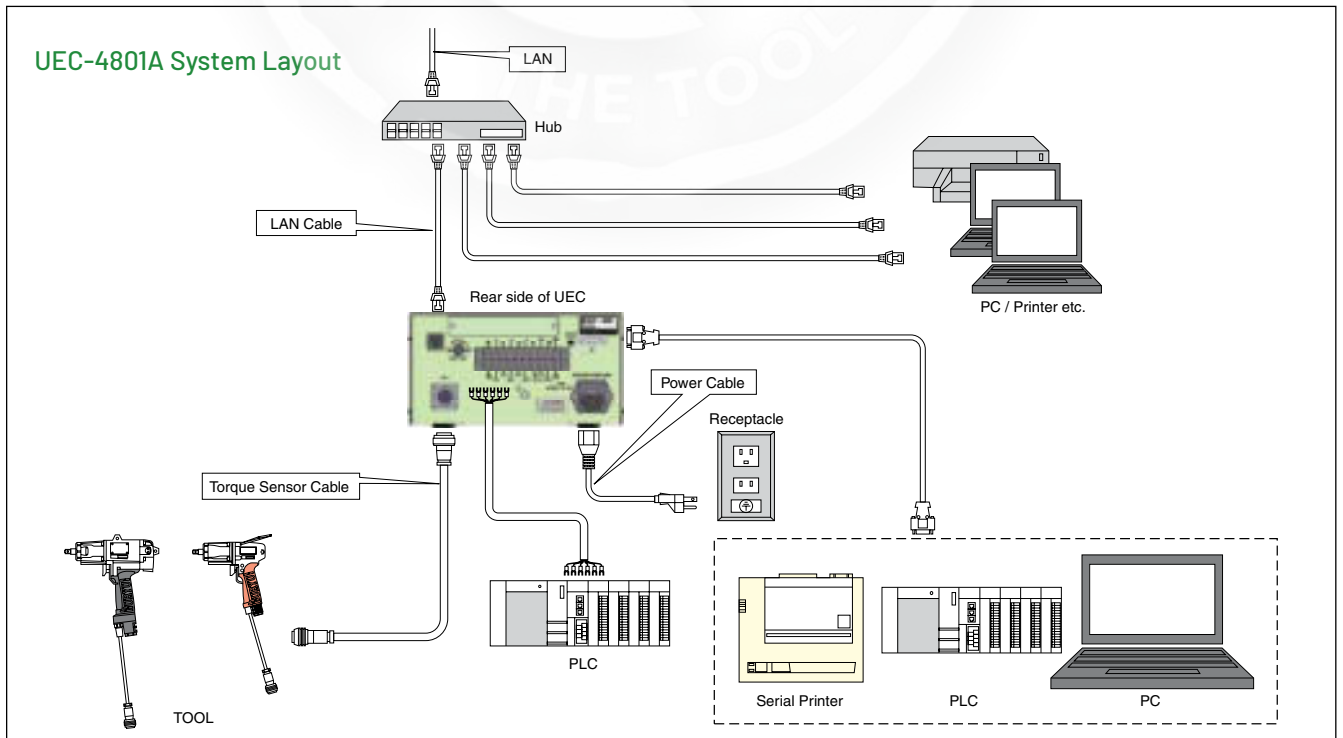

# Uryu Controllers

## UEC-5500 CONTROLLER



UEC-5500

### UEC-5500

#### FEATURES AND BENEFITS

Multi-spindle controller that includes all of the features of the UEC-4801A model, plus it can control 4 spindles simultaneously.

- Easy programming with removable key pad
- 20,000 data point memory per spindle

USE UEC-5500 WITH THE FOLLOWING TOOLS



UA-MC Series



UA-SMC Series



UXR-SMC Series



UXR-MC Series



### UEC-5500 System Layout

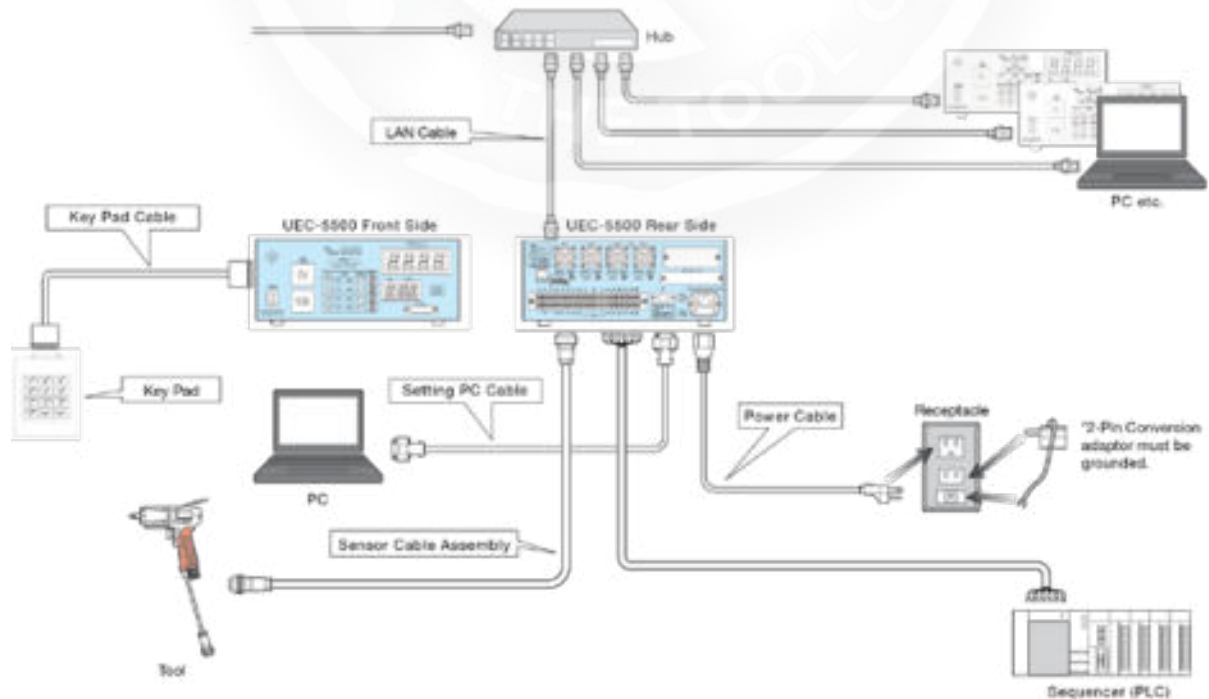

## UECP-4810 CONTROLLER



### UECP-4810

#### FEATURES AND BENEFITS

- Used exclusively for UDP series tools
- Integrates Tool Driver and UEC-4801A Controller - no separate box
- Windows-based PC software included
- Programmable tool speeds
- Motor setting:
  - Motor current can be set in four steps
  - Motor rotational speed can be set in 100 rpm increments
- Fastening error detection and fastener number countdown functions ensure seamless operation
- Allows setup or changeover of fastening torque and fastening number count
- Tool's maintenance is possible by counting both total cycle numbers (how many fasteners) and/or total pulse numbers.
- Input/Output check and error messages can be checked from your PC or the front panel, which will notify you with a buzzer
- Set up and monitor various control values. Values can be set either on the front panel or on the PC
- Ethernet (TCP/IP) capable. Upload and receive setting values. Upload fastening result/waveform data through PC software

#### UECP-4810(A) System Layout

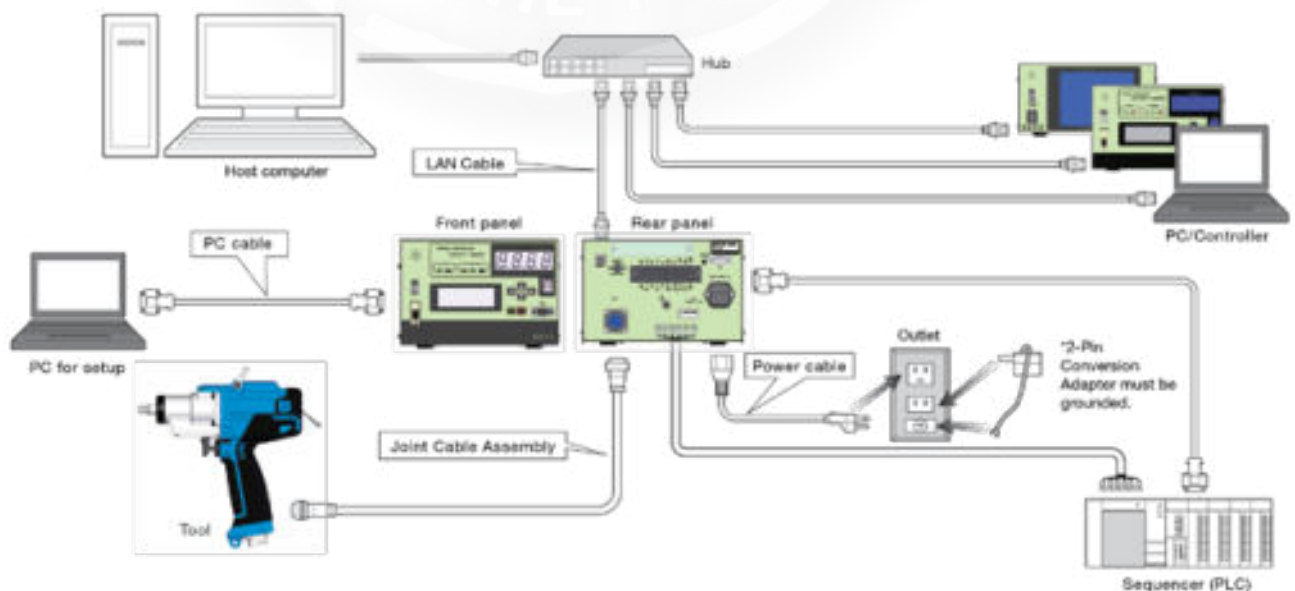

# Uryu Controllers

## UCC-100Z CONTROLLER



UCC-100Z

USE UCC-100Z WITH THE FOLLOWING TOOLS



UBX-AF Series

### UCC-100Z

#### FEATURES AND BENEFITS

- Used exclusively for UBX-AF series tools
- Windows-based PC software included
- Programmable tool speeds
- Set up and monitor various control values. Values can be set either on the front panel or on the PC
- Pairing parameter is selectable from 3 types:
  - Manual pairing by dip switches
  - Pairing through software
  - Wireless pairing
- Two UBX-AF tools can be paired to one UCC-100Z controller
- Input/Output check and error messages can be checked from your PC or the front panel, which will notify you with a buzzer

#### UCC-100Z System Layout

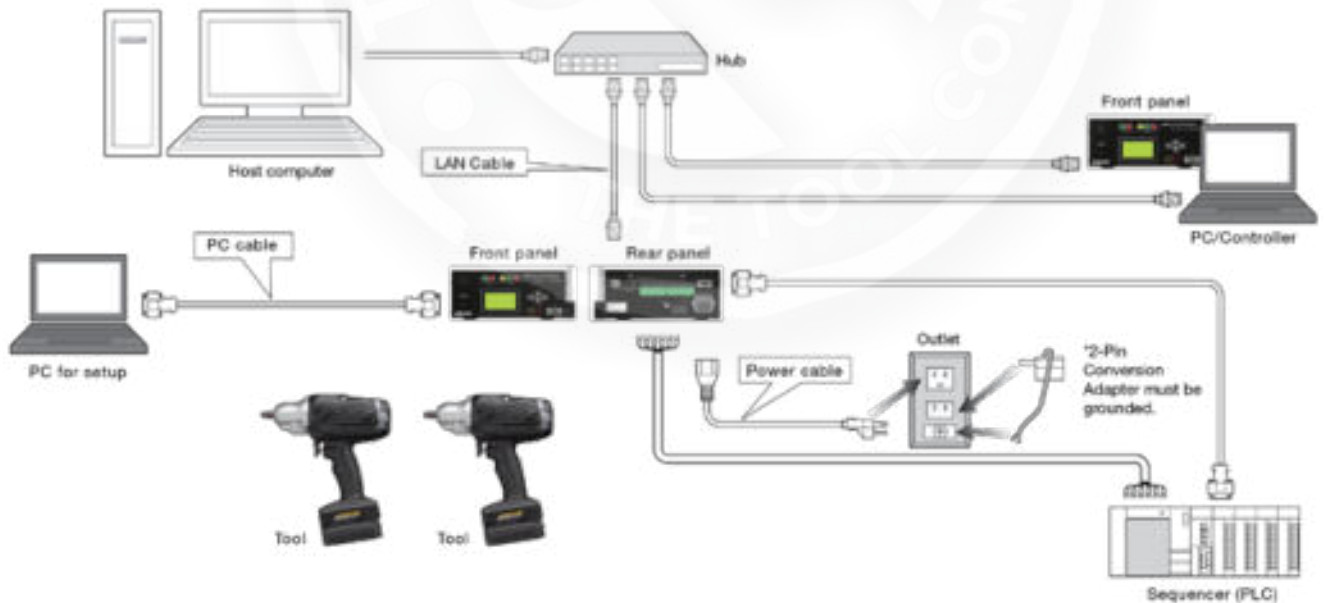

# Uryu Controllers

## URYU CONTROLLER SPECIFICATIONS

Model	24v I/O	Uryu Data, Barcode, & Printer	Ethernet Protocols	Touch Panel Display	Angle Monitoring
<b>UEC Controller for UA-AMC/SMC, UA-MC, and UXR-MC/SMC Series</b>					
UEC-4801	X	X	X		
UEC-4801A-ANGLE	X	X	X		X
UEC-5500 (Multi Spindle)	X	X	X		X with angle board
<b>UECP Controller with Tool Driver for UDP Series Tools</b>					
UECP-4810A	X	X			
<b>UCC Controller for UBX-AF Series Tools</b>					
UCC-100ZA	X	X	X	X	X



	UEC-4801A / UEC-4801A-ANGLE	UEC-5500	UECP-4810 (A)	UCC-100Z
Power Supply	AC100~240V ±10%			
Power Frequency	50/60 Hz			
Insulation Protection	DC500V over 10MΩ			
Power Consumption	Approx. 30VA	Approx. 50VA	Approx. 30VA	Approx. 35VA
Weight	Approx. 3.6 kg		Approx. 11.30 kg	Approx. 2.9 kg
Dimensions	265(d) x 222(w) x 120(h)	240(d) x 270(w) x 115(h)	265(d) x 222(w) x 200(h)	254(d) x 233.5(w) x 106(h) (with antenna)
Main Functions	Torque Monitoring/Control + Fastening Counter			Torque Control + Angle Monitoring + Fastening Counter
Parameter Setup	<ul style="list-style-type: none"> <li>PC (with setup software)</li> <li>Manual Input on front LCD panel</li> </ul>	<ul style="list-style-type: none"> <li>PC (with setup software)</li> <li>Removable key pad</li> </ul>	<ul style="list-style-type: none"> <li>PC (with setup software)</li> <li>Manual Input on front LCD Panel</li> </ul>	
Display	Torque Resolution ±2048 (12-Bit A/D) <b>UEC-4801A</b> <ul style="list-style-type: none"> <li>LCD: 20 characters x 4 lines</li> <li>Contents: Work No., Fastening Countdown No., Fastening Time, Pulse No.</li> <li>1-digit digital display (DPM): Work No.</li> <li>4-digit digital display (DPM): Torque</li> </ul>	Torque Resolution ±2048 (12-Bit A/D) <ul style="list-style-type: none"> <li>4-digit digital display: Torque</li> <li>2-digit digital display: Fastening Countdown</li> <li>1-digit digital display (small) x 4: Work No.</li> <li>1-digit digital display (large) x 4: Spindle No.</li> </ul>	Torque Resolution ±2048 (12-Bit A/D) <ul style="list-style-type: none"> <li>LCD: 20 characters x 4 lines</li> <li>Contents: Work No., Bolt Count No., Tightening Time, Pulse Blow No.</li> <li>1-digit digital display (DPM): Work No. displayed</li> <li>4-digit digital display (DPM): Torque reading displayed</li> </ul>	Torque Resolution ±2048 (12Bit A/D) <ul style="list-style-type: none"> <li>LCD: 20 Characters x 8 lines</li> <li>Contents: Work No., Fastening Countdown, Fastening Time, Pulse No., Angle, Error message</li> </ul>
LED	COUNT Lamp: OK (Green), NOK (Red)	TORQUE Lamp: LOW (Yellow), OK (Green), HIGH (Red)		FASTENING Lamp: LOW (Yellow), OK (Green), HIGH (Red)
Input Terminal Signal	<ul style="list-style-type: none"> <li>Operation Voltage/Current: DC24V/approx. 10mA</li> <li>6 terminals (free format), VALVE</li> </ul>	<ul style="list-style-type: none"> <li>Drive by Electric Current Input (photo coupler insulation)</li> <li>Voltage: DC24V</li> <li>Insulation Resistance: 4.7KΩ</li> <li>12 terminals (free format), VALVE, +24V</li> </ul>	<ul style="list-style-type: none"> <li>Operation Voltage/Current: DC24V, approx. 10mA</li> <li>6 terminals (programmable). Note: Contact input necessary</li> </ul>	
Output Terminal Signal	<ul style="list-style-type: none"> <li>Contact Capacity: AC:125V, 0.3A, DC:30V, 1A</li> <li>6 terminals (free format), VALVE</li> </ul>	<ul style="list-style-type: none"> <li>Contact Capacity: AC:125V, 0.3A, DC:30V, 1A</li> <li>8 terminals (free format), VALVE, +24</li> </ul>	<ul style="list-style-type: none"> <li>Contact Capacity: DC 30V, 1A</li> <li>6 terminals (programmable), VALVE</li> </ul>	<ul style="list-style-type: none"> <li>Contact Capacity: DC30V, 1A</li> <li>6 Terminals (free format)</li> </ul>

# Uryu Controlled Pulse Tool Cables / Controller Brackets



910-623-0



EC/MCCBL-25



910-808-0



911-023-0

## CONTROLLED PULSE TOOL CABLES

Part #	Description	Function	Length		Tool Series				Controller Platform	
			M	FT	UA-MC	UA-AMC	UDP-MC	UXR-MC	UEC-4801A	UECP-4810
910-807-0	Joint Cable Assy.	Tool Cable to Controller	5	18			X			X
910-808-0	Joint Cable Assy.	Tool Cable to Controller	10	35			X			X
910-547-0	Joint Cable Assy.	Tool Cable to Controller	5	18						
910-548-0	Joint Cable Assy.	Tool Cable to Controller	10	35						
EC/MCCBL-10	Sensor Cable Assy.	Tool Cable to Controller	3	10	X	X		X	X	
EC/MCCBL-25	Sensor Cable Assy.	Tool Cable to Controller	7	25	X	X		X	X	
EC/MCCBL-30	Sensor Cable Assy.	Tool Cable to Controller	9	30	X	X		X	X	
EC/MCCBL-35	Sensor Cable Assy.	Tool Cable to Controller	10	35	X	X		X	X	
EC/MCCBL-40	Sensor Cable Assy.	Tool Cable to Controller	12	40	X	X		X	X	
EC/MCCBL-45	Sensor Cable Assy.	Tool Cable to Controller	13	45	X	X		X	X	
EC/MCCBL-50	Sensor Cable Assy.	Tool Cable to Controller	15	50	X	X		X	X	
EC/MCCBL-55	Sensor Cable Assy.	Tool Cable to Controller	17	55	X	X		X	X	
EC/MCCBL-60	Sensor Cable Assy.	Tool Cable to Controller	18	60	X	X		X	X	
EC/MCCBL-75	Sensor Cable Assy.	Tool Cable to Controller	22	75	X	X		X	X	
911-023-0	Encoder "Y" Cable	Enables Angle Sensor. Splits Tool Cable to Controller	0.3	1		X			X*	
910-623-0	Sensor Cable Assy.	External Driver Box to Controller	0.3	1					X	

\* Requires Controller with Angle Encoder Board installed

## TOOL HOLDERS

Rubber tool holders protect tool's torque sensor when not in use.



Model	Description	Used For
852-644-1	Rubber Tool Holder	ULT / UAT / UL 30 - 70 series
852-644-1 KIT	Rubber Tool Holder with Bracket	UX 450 - 500 series UD-50 / UD-60 series
852-669-1	Rubber Tool Holder	ULT / UAT / UL / UA-MC / UX / UX-T 612 - 800 series
852-669-1 KIT	Rubber Tool Holder with Bracket	UW-6 / UW-ST6 series
852-645-1	Rubber Tool Holder	ULT / UAT / UL / UA-MC 90 - 130 series
852-645-1 KIT	Rubber Tool Holder with Bracket	UX-T 700 series UW-8 / UW-9 series

## TOOL HOLDER FOR SMALLER TOOLS



The Mini Tool Holder allows operators a safe and stable way to store tools.

- Easily adapt to the worker's position, creating an ergonomic workspace and reducing project setup time
- Durable construction with inner steel reinforcement
- Does not damage plastic power tool bodies
- Holds tools with maximum diameter of 42 mm

Model	Description
0007.08	Mini tool holder with bracket

# Fixtured F-Series Nutrunners



## FEATURES AND BENEFITS

- Reduced Cable Numbers – Integral type tube containing torque sensor cable and resolver cable
- Enhanced Memory Capacity – Designed with increased memory capacity for improved efficiency of assembly line and tightening data control
- Open Network Communication – Various communication boards are available (M-NET, Device net, Inter-bas, CC-link)
- Automatic Setting (Automatic recommended value input) – Advance value preparation per application will help you simplify your parameter setting
- Space Saving – One-piece spindle controller/driver unit reduces space occupancy by 40% to 60%

No. of Spindles	Volume & Width Before		Volume & Width With F-Series					
	CM	MM	UEC-F024H		UEC-F060H		UEC-F120H	
1-Spindle	16,800	200	5,512	130	6,106	144	6,784	160
2-Spindle	24,360	290	8,056	190	9,243	218	10,600	250
5-Spindle	47,040	560	15,688	370	18,656	440	22,048	520
10-Spindle	84,840	1,010	28,408	670	34,344	810	41,128	970

## F-SERIES NETWORK CONNECTIVITY

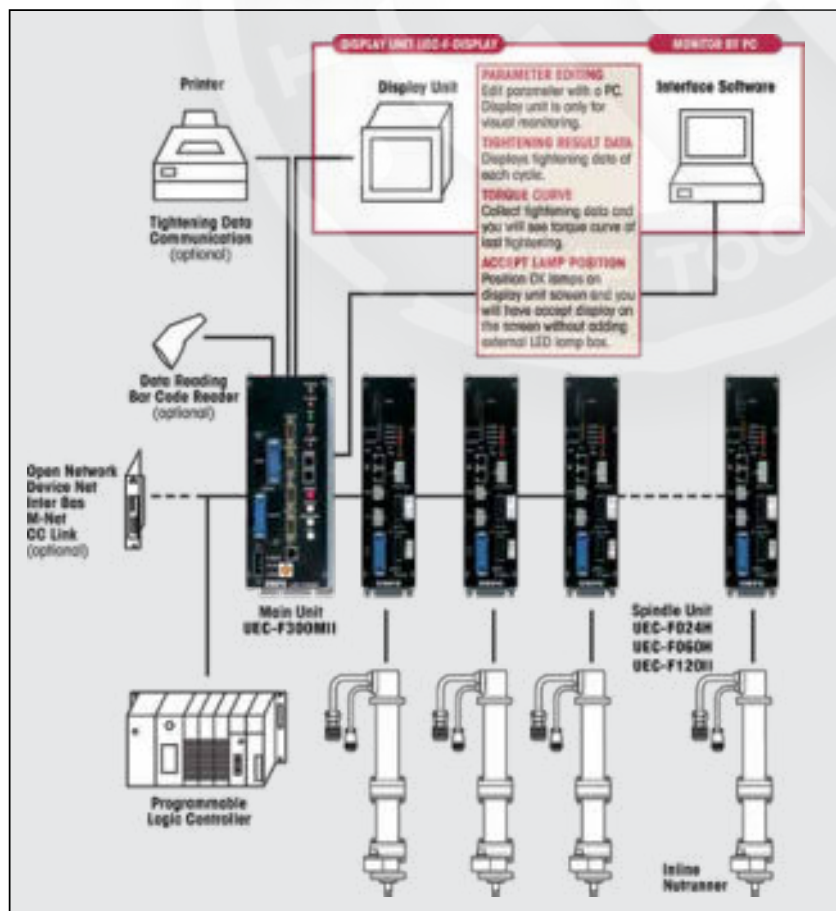

# Fixtured F-Series Nutrunners

## Main Unit UEC-F300MII

Controls up to 31 spindle units and directs fastening

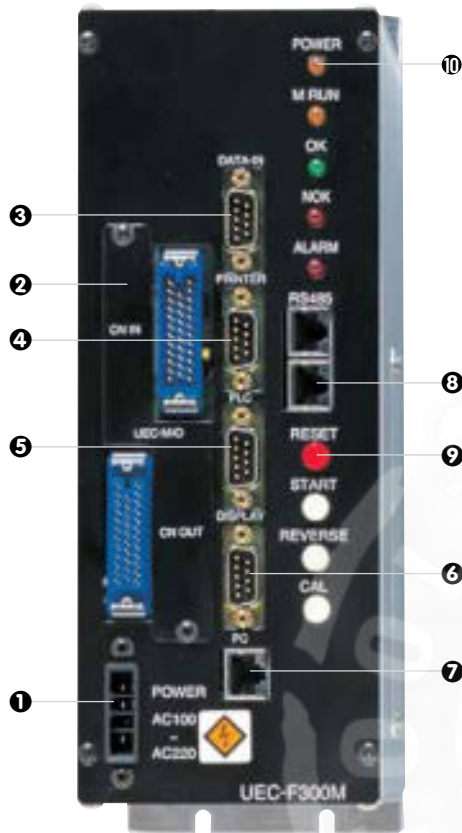

## Spindle units UEC-F024H & UEC-F060H minus UEC-MKB

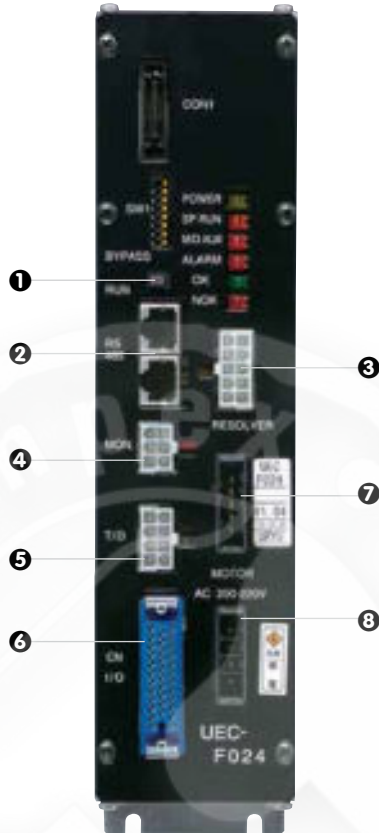

## UEC-F024H with optional UEC-MKB display unit

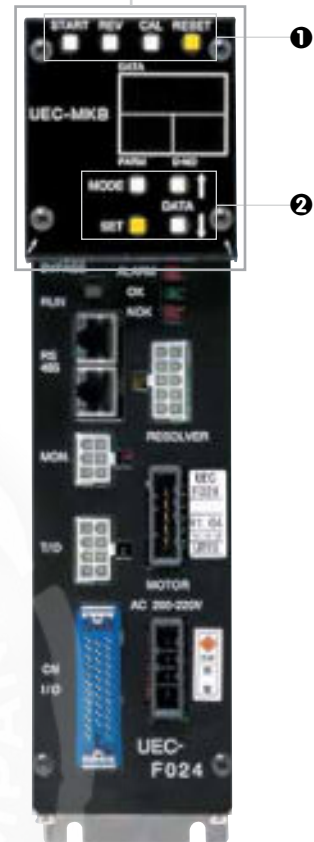

- 1 Power Socket**  
AC100-220V single phase
- 2 External Input/Output Connector**  
PLC1: input signal connector for control signal input (fixed allocation)  
PLC2: output signal connector for judgement result and status output (free allocation)
- 3 Serial Port (Data Input Connector)**  
RS232C DATA-IN accepts serial numbers, etc. provided by external equipment such as a barcode reader then outputs tightening data together with serial numbers
- 4 Serial Port (Data Output Connector)**  
RS232C PRINTER outputs tightening result data to your printer (free format)
- 5 Serial Port (Data Output Connector)**  
RS232C PLC outputs tightening result data to PLC (free format)
- 6 Serial Port (Data Output Connector)**  
RS485 outputs tightening result data to an external exclusive display unit
- 7 PC Connector**  
RS232C for communication with a PC
- 8 Spindle-to-Spindle Communication Connector**  
RS485 for internal spindle unit to spindle unit communications
- 9 Manual Switches**  
RESET, START, REVERSE and CAL
- 10 LED Display**  
POWER, M RUN, ACCEPT, REJECT and ALARM

- 1 Status Change Switch**  
RUN/BYPASS change switch  
RUN: Operation possible status  
BYPASS: Non-operation status
- 2 External Communication Device**  
RS485 connector
- 3 Resolver Connector**  
Tool and resolver connection
- 4 MON Connector (Monitor Output)**  
Analog torque electric pressure and angle pulse output
- 5 T/D Connector**  
Tools torque sensor connection
- 6 I/O Connector**  
External input and output control connection
- 7 MOTOR Connector**  
Connection with tools magnet motor
- 8 AC IN Connector**  
AC200V-220V 3-phase power socket

- 1 Manual Operation Switches**  
START: manual start switch  
REVERSE: Manual reverse switch  
CAL: Manual calibration switch  
RESET: Manual reset switch
  - 2 Data Display Operation Switch**  
MODE switch  
SET switch  
DATA UP switch  
DATA DOWN switch
- NOTE: Display unit (UEC-MKB) is an option



# Fixtured F-Series Nutrunners

## INLINE NUTRUNNERS

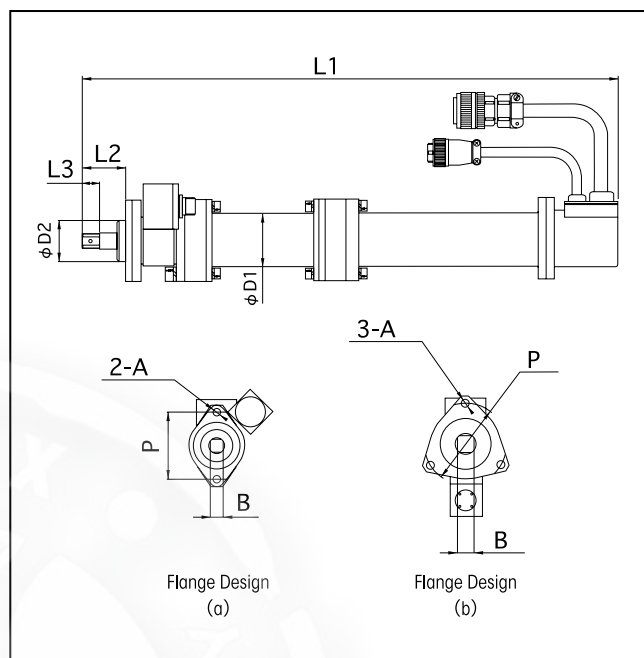

The "F" Series Nutrunner System will satisfy multiple tightening patterns.

- Torque tightening
- Spline press fit tightening
- Torque
- Pin hole alignment tightening
- Angle tightening
- Pre-load detection
- Angle
- Idle operation check
- Plastic range monitor

Rated Strain	2000X10-6
Output Voltage	1.0 mV/V
Non-Linearity	±0.5% R.O.
Influence on Zero Point Due to Temperature	±0.1% R.O./°C
Temperature Rating	-10~+65°C
Input Output Resistance	480Ω
Maximum Input Voltage	16V
Insulation Resistance	Greater than 300Ω
Overload Capacity	150%

### F-Series Inline Nutrunner Specifications

Model	External Dimensions (Mm)								Torque Sensor	Capacity NM	Motor Type	Tightening Torque NM	Free Speed RPM	Weight KG	Spindle Unit	Flange Design
	L1	L2	L3	D1	D2	P	A	B								
UNR-F015-45NT	371	41	12	40.5	38	51	M6	9.5	TM-035	34.3	F015	4.5	3,200	2.48	UEC-F024H	(a)
UNR-F015-65NT	371	41	12	40.5	38	51	M6	9.5	TM-035	34.3	F015	6.5	2,200	2.48	UEC-F024H	(a)
UNR-F015-200NT	400	41	12	40.5	38	51	M6	9.5	TM-035	34.3	F015	20	730	2.73	UEC-F024H	(a)
UNR-F015-280NT	400	41	12	40.5	38	51	M6	9.5	TM-035	34.3	F015	28	500	2.73	UEC-F024H	(a)
UNR-F015-350NT	400	41	12	40.5	38	51	M6	9.5	TM-035	34.3	F015	35	410	2.73	UEC-F024H	(a)
UNR-F050-270NT	453.5	41	12	50	38	51	M6	9.5	TM-035	34.3	F050	27	1,750	4.86	UEC-F060H	(a)
UNR-F050-630NT	500.5	41	16.5	50	38	62	M8	12.7	TM-085	83.3	F050	63	750	5.08	UEC-F060H	(a)
UNR-F050-730NT	500.5	41	16.5	50	38	62	M8	12.7	TM-085	83.3	F050	73	650	5.08	UEC-F060H	(a)
UNR-F050-880NT	512.5	45	20	50	48	62	M8	15.88	TM-150	147	F050	88	540	5.47	UEC-F060H	(a)
UNR-F050-1400NT	512.5	45	20	50	48	62	M8	15.88	TM-150	147	F050	140	340	5.47	UEC-F060H	(a)
UNR-F100-1300NT	519.5	45	20	62	48	62	M8	15.88	TM-150	147	F100	130	730	7.42	UEC-F120II	(a)
UNR-F100-1900NT	515.5	45	20	62	48	76	M8	15.88	TM-250	245	F100	190	500	7.94	UEC-F120II	(b)
UNR-F100-2500NT	515.5	45	20	62	48	76	M8	15.88	TM-250	245	F100	250	370	7.94	UEC-F120II	(b)
UNR-F100-3700NT	589	57	30	62	58	76	M10	19	TM-400	392	F100	370	260	9.55	UEC-F120II	(b)
UNR-F100-5400NT	704.5	80	40	62	70	90	M10	25.4	TM-700	686	F100	540	175	17.0	UEC-F120II	(b)
UNR-F100-7000NT	704.5	80	40	62	70	90	M11	25.4	TM-700	686	F100	700	120	17.0	UEC-F120II	(b)
UNR-F100-10000NT	704.5	80	40	62	70	90	M11	25.4	TM-1000	980	F100	1,000	90	17.0	UEC-F120II	(b)

# Fixtured F-Series Nutrunners

## "F" NUTRUNNER MOTORS' MINIMUM PITCH CIRCLE

Refer to minimum pitch circles for designing your machine.

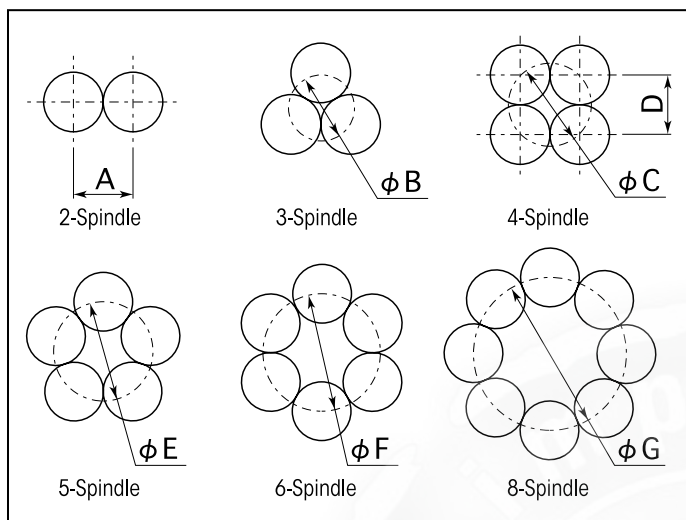

TYPE	Dimensions (MM)						
	A	B	C	D	E	F	G
UNR-F015-45NT	43	52	64	46	74	92	122
UNR-F015-65NT	43	52	64	46	74	92	122
UNR-F015-200NT	43	52	64	46	74	92	122
UNR-F015-280NT	43	52	64	46	74	92	122
UNR-F015-350NT	43	52	64	46	74	92	122
UNR-F050-270NT	59	72	90	64	108	122	160
UNR-F050-630NT	59	72	90	64	108	122	160
UNR-F050-730NT	59	72	90	64	108	122	160
UNR-F050-880NT	59	72	90	64	108	122	160
UNR-F050-1400NT	59	72	90	64	108	122	160
UNR-F100-1300NT	66	75	92	65	116	130	170
UNR-F100-1900NT	70	100	110	78	115	132	174
UNR-F100-2500NT	70	100	110	78	115	132	174
UNR-F100-3700NT	76	100	110	78	120	140	184
UNR-F100-5400NT	94	125	143	102	166	188	257
UNR-F100-7000NT	94	125	143	102	166	188	257
UNR-F100-10000NT	94	125	143	102	166	188	257

## RIGHT ANGLE NUTRUNNERS

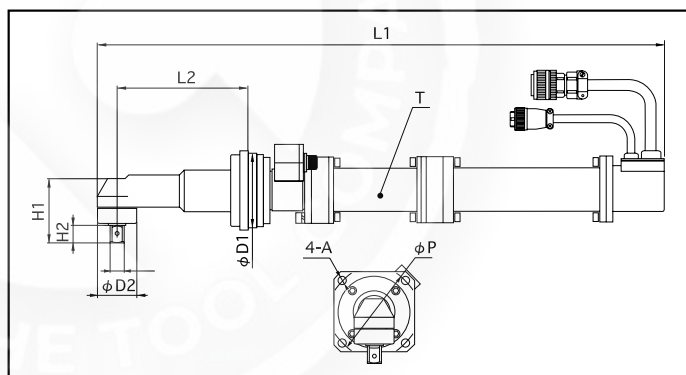
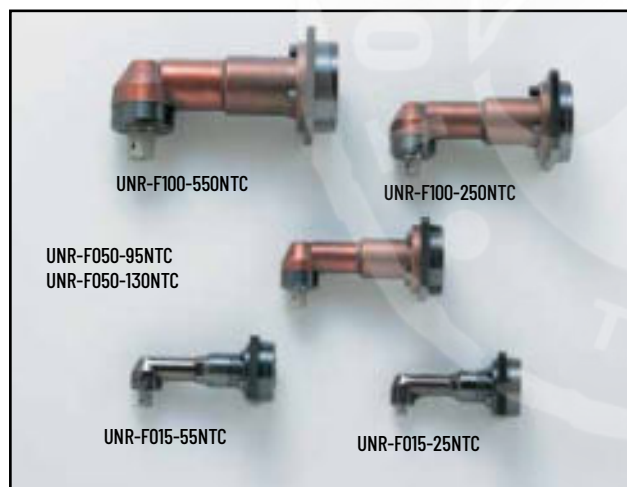

## F-Series Right Angle Nutrunner Specifications

Model	External Dimensions (Mm)									Straight Motors			Tightening Torque (NM)	Free Speed (RPM)	Weight (KG)	Spindle Unit
	L1	L2	H1	H2	D1	D2	P	A	B	Type	Sensor	Motor				
UNR-F015-25NTC	507	120	49	10.6	70	28	85	M6	9.5	UNR-F015-200NT	TM-035	F015	25	460	4.18	UEC-F024
UNR-F015-55NTC	521	130	58	18	70	36	85	M6	12.7	UNR-F015-350NT	TM-035	F015	55	260	4.37	UEC-F024
UNR-F050-95NTC	643	150	73.5	20	85	45	102	M6	15.88	UNR-F050-630NT	TM-085	F050	95	480	8.08	UEC-F060
UNR-F050-130NTC	649	150	73.5	20	85	45	102	M6	15.88	UNR-F050-880NT	TM-150	F050	130	340	8.3	UEC-F060
UNR-F100-200NTC	681.5	170	85.5	20	85	56	102	M6	15.88	UNR-F100-1300NT	TM-150	F100	200	460	11.92	UEC-F120
UNR-F100-250NTC	677.5	170	85.5	20	100	56	120	M8	15.88	UNR-F100-1900NT	TTM-150	F100	250	340	12.3	UEC-F120
UNR-F100-380NTC	716.5	200	109.5	25	110	74	134	M10	19	UNR-F100-2500NT	TM-250	F100	380	235	15.92	UEC-F120
UNR-F100-550NTC	784	200	114.5	29	110	74	134	M10	25.4	UNR-F100-3700NT	TM-400	F100	550	165	17.43	UEC-F120

# Torque Measurement: Overview

Torque measurement and the verification of torque tools and applied torque are an integral part of today's threaded assembly process. The method used to measure torque can affect the judgments made regarding tool performance, assembly processes and overall product quality.

## DYNAMIC TORQUE

Dynamic torque is the torque produced during the actual tightening process, normally measured using rotary transducers and a torque analyzer.

### Advantages:

- Reduces operator influence
- Measures applied torque
- Can also include angle of rotation as error proofing parameter

## RESIDUAL TORQUE

Residual torque is the torque measured by producing an incremental amount of movement of the fastener after the actual tightening process, normally measured using a dial or digital torque wrench.

### Advantages:

- Easy access to fastener
- Error proofing
- Can detect missed fasteners or joints with significant relaxation

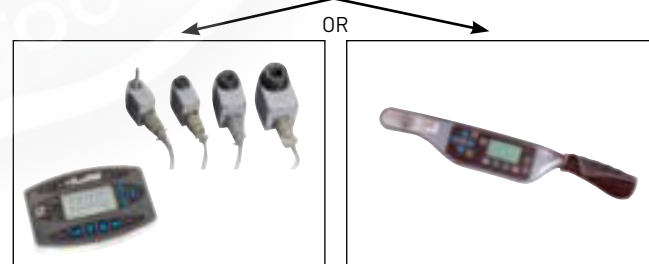
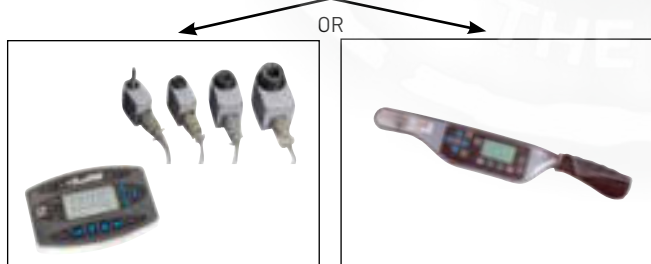
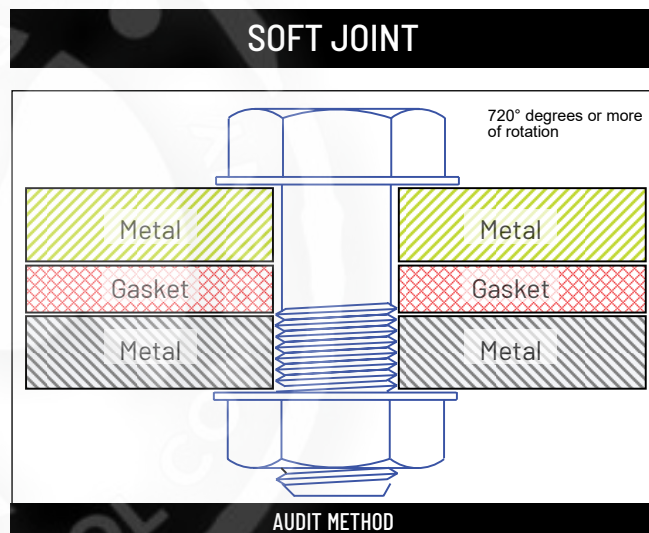
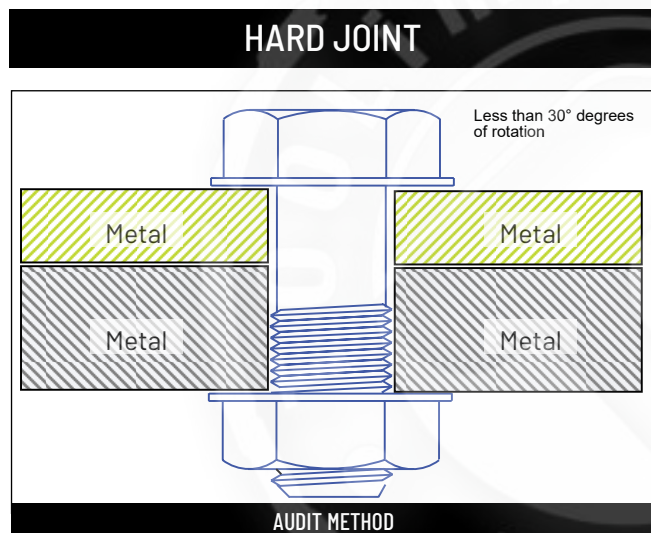

Dynamic Torque: 15 Nm

Residual Torque: 18 Nm

Dynamic Torque: 15 Nm

Residual Torque: 12 Nm

Values as examples only

Values as examples only

A hard joint, one requiring a low degree of rotation during tightening, will normally show very little relaxation after tightening. Due to the high amount of remaining clamp load and friction within the joint members, additional movement of the fastener requires additional torque energy to be applied. Therefore, Residual Torque values will be higher than Dynamic Torque values.

A soft joint, one requiring a high degree of rotation during tightening, will normally show significant amounts of relaxation after tightening. Relaxation leads to a loss of clamp load and friction within the joint members. Due to this relaxation, additional movement of the fastener requires relatively small amounts of additional torque energy and Residual Torque values will be lower than Dynamic Torque values.

# Torque Measurement: Overview

Checking torque measurement before, during, and after assembly ensures quality manufacturing. Proper torque measurement is critical in many assembly operations. AIMCO utilizes years of experience to design a process around your specific auditing requirements. From simple dial wrenches to electronic data collectors and joint analyzers for R&D, AIMCO is with you every step of the way.

## BEFORE ASSEMBLY

### Tool Capability



#### Is the tool working correctly?

Testing and verifying tools under controlled conditions helps you identify accuracy and repeatability before using them in production.

#### Equipment used:

- Desktop testers with internal transducers
- Auditor analyzers with either stationary or rotary transducers
- UFT hydraulic joint simulators and rotary transducers

## DURING ASSEMBLY

### Process Capability



#### How does the tool work with the product being assembled?

Testing the tools during the actual process helps ensure that the process is working correctly. Variables in the parts and influences from the operator can be accounted for.

#### Equipment used:

- Torque Data Collectors/ Analyzers
- Auditor Rotary Transducers

## AFTER ASSEMBLY

### Product Capability



#### Does the finished product meet expectations?

Checking the product after assembly is the final opportunity to verify that product quality is satisfactory before user delivery

#### Equipment used:

- Click/Dial wrenches
- Electronic wrenches with Auditor analyzers
- Rotary transducers and Auditor analyzers with hand driver to move fastener



# Torque Measurement: Overview

## MEASURING QUALITY – PROCESS CAPABILITY

### Statistical Analysis Is An Important Step In Any Quality Control Process

One of the most widely accepted statistical indicators of process quality, and therefore product quality, is Cpk, or the process capability for a centered process. This value indicates how capable a process is and whether the results of that process are properly centered near a specific target. A capable process is one that approaches, as a limit, 100% conformance to specifications.

Cpk is a statistical value that indicates how tightly grouped a series of samples is around the target value. Cpk is a function of the Upper Specification Limit (USL), the Lower Specification Limit (LSL), the mean of the samples and the standard deviation ( $\sigma$ ) of the samples.

$$Cpk = \text{either } \frac{(USL - \text{Mean})}{(3 \times \sigma)} \text{ or } \frac{(\text{Mean} - LSL)}{(3 \times \sigma)}, \text{ whichever is smaller.}$$

An acceptable, or capable, process will normally have a Cpk value of at least 1.33.

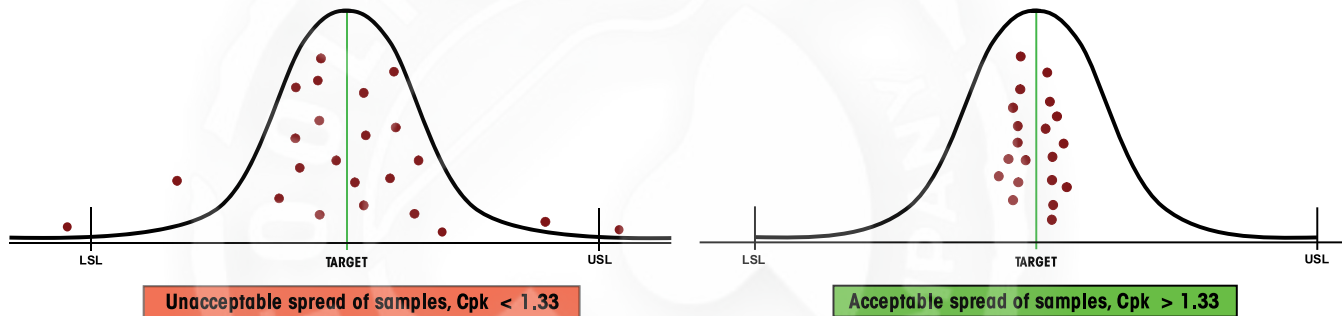

## MEASURING QUALITY – CLAMP LOAD

The purpose of threaded fastening is to produce the correct amount of clamp load within the joint.



Due to the cost and difficulty of measuring clamp load during the actual assembly process, torque is used as the control parameter during tightening. Many manufacturers use torque values as the primary indicator of threaded assembly quality. However, achieving repeatable clamp load is a better indicator of joint quality.

Studies have shown that discontinuous drive tools can produce equal or better clamp load results when compared to continuous drive tools.

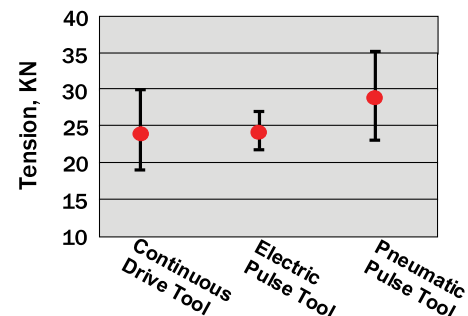
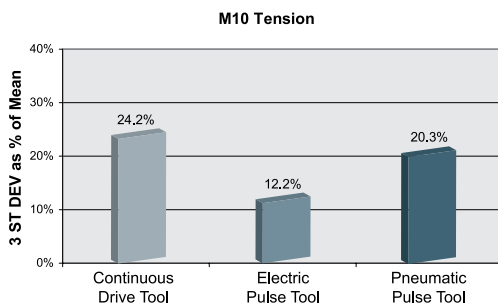

# Torque Measurement: Overview



Torque Measurement Systems										
Devices	Model Series	Data Collector	Integrated Transducer	Torque Wrench	Torque Wrench Loader	External Transducer Port	Stationary Transducers -Smart	Stationary Transducers -Ind Std	Rotary Transducer -Smart	Rotary Transducer - Ind Std
Testers	ATC		X							
	AUET		X							
	AUET-DC	X	X							
	AUET/MTM		X			X				
	AUET/MTM-DC	X	X			X				
Analyzers	ATDA					X				
	ATDA-DC	X				X				
Test Stands	AHCTS*	X*	X*	X*			X*	X*	X*	X*
	AHCTS-K*	X*	X*	X*			X*	X*	X*	X*
	AHDS*	X*	X*	X*			X*	X*	X*	X*
	AIMTS*	X*	X*	X*			X*	X*	X*	X*
Wrenches	ADW			X						
	ADW-DC	X								
	APTW			X						
	ATW			X						
	ATWL					X				
Torque Cart	iTVC*	X*	X*	X*			X*	X*	X*	X*
Transducers	ARTIS									X
	ASTIS							X		
	AISI						X			
	AISF						X			
Rundown Fixtures	AJKR									
	AJKS									
	ARDFA									
	ARDIA									
Joint Simulator	UFT									

\*configured to customer specifications





# Torque Measurement: Overview

## Torque Measurement: Testers

### Features and Benefits

- Heavy industrial design
- All software included
- Auditor Torque Testers are designed for intuitive and functional usability. AUET/MTM models are available with our unique dual integrated torque transducer package.

Testers are designed to audit torque wrenches and power tools, including pulse tools

					
	ATC	AUET	AUET/MTM	AUET-DC	AUET/MTM-DC
Auditor Torque Cube	Auditor Torque Cube	Auditor Universal Electronic Tester	Auditor Universal Electronic Tester - Multiple Transducer Module	Auditor Universal Electronic Tester - Data Collector	Auditor Universal Electronic Tester/Multiple transducer Module - Data Collector
	Compact vertical or horizontal bench-mount tester.	Bench mount or line side tester utilizing integrated transducer.	Bench mount or line side tester with dual integrated transducer and external transducer capacity.	Bench mount or line side tester utilizing integrated transducer. Provides data collection capability with included software to interface with PC.	Bench mount or line side tester with dual integrated transducer and external transducer capacity. Data collection capability with included software to interface with PC.
Integrated Transducer Range (values are in full scale)	1 - 1,350 Nm 100 in-oz - 1,000 ft-lb	1 - 1,000 Nm 100 in-oz - 750 ft-lb	1 - 1,000 Nm 100 in-oz - 750 ft-lb	1 - 1,000 Nm 100 in-oz - 750 ft-lb	1 - 1,000 Nm 100 in-oz - 750 ft-lb
External Transducer Capacity (Transducer sizes exceeding this range may be special ordered)			up to 5,000 ft-lb		up to 5,000 ft-lb
Vertical / Horizontal Mount	X				
Bi-directional accuracy of +/- X of indicated reading within the top 90% of the tester's capacity	1%	0.50%	0.50%	0.50%	0.50%
Data Output to PC	X	X	X	X	X
Integrated Torque Transducer	1	1	2	1	2
External Transducer Port			X		X
Number of Stored Readings	999	999	999	999	999
Adjustable Rundown Fixture Included *	1	1	2	1	2
Rechargeable NiMH Battery	X	X	X	X	X
<b>Measurement Modes</b>					
Peak	X	X	X	X	X
First Peak (Click)	X	X	X	X	X
Pulse	X	X	X	X	X
Track	X	X	X	X	X
Units of Measure Options	8	8	8	8	8
Tool Manager Software Included				X	X

\* Included with all testers and analyzers with a range up to 1000 in-lb.

## Torque Measurement Testers Used In Conjunction With

### External Transducers

ASTIS - Stationary			X		X
AISI / AISF - Stationary - Analog			X		X
ARTIS - Rotary			X		X

### Switch box for External Transducer

AISWT-4L > 4 Way Intellect box			X		X
AISWT-6L > 6 Way Intellect box			X		X

### Cables

ICBL-USB - USB Serial > PC	X	X	X	X	X
ATDBLIS - IS Transducer w/angle (10 Pin)			X		X
ATDBRIS - IS Transducer (4 Pin)			X		X
ICBL-10P - Intellect transducer cable Identification chip in cable - 10 pin connector			X		X
ICBL-4P - Intellect transducer cable. Identification chip in cable - 4 pin connector			X		X
ICBL-5000L - Connect from AUET/MTM & ATDA to Intellect Transducers, Analog AISI / AISF			X		X

# Auditor Torque Cube



ATC-10  
ATC-25  
ATC-100  
ATC-250  
ATC-500  
ATC-750  
ATC-1800



ATC-150F  
ATC-250F  
ATC-500F  
ATC-750F



## AUDITOR TORQUE CUBE

The Auditor Torque Cube (ATC) is a compact, versatile desktop tester that provides a multitude of capabilities. The ATC is designed to test hand or power tools with the following:

- Peak, first peak, and track modes
- Multiple engineering units
- Manual and auto clear function
- Multiple frequency response settings
- Bi-directional use and accuracy
- Accuracy is better than 1% of indicated reading top 90% of range
- Serial data output
- Memory: 999 data samples
- Battery and/or mains powered

Because precision and quality are critical, you can depend on Auditor testers to calibrate and certify your tools. Whether you are assembling large complicated systems or small precise time pieces, AIMCO provides the best system for your application. Our instruments have been judged "best in class" by independent National Standards laboratories. Auditor Torque Cube is rugged enough to test and verify tools at "point of use" while still being accurate enough to calibrate hand and power tools.

Each tester is shipped with a mains/battery charger power cord, a hex to allen drive bit, and a bolting template. Models with max torque of 1,000 in-lb or less also include a joint rundown fixture. The ATC can be positioned vertically or horizontally for the ergonomic testing of inline or pistol grip tools.

## ATC Auditor Torque Cube Models

Model	Recommended Torque Range		KG	Weight		W x H x D		Square Drive IN
	NM	IN-LB/FT-LB		LB	MM	IN		
<b>Vertical Configuration</b>								
ATC-10	0.13 - 1.13	1 - 10 in-lb	1.13	2.5	79 x 95 x 83	3.13 x 3.75 x 3.25	1/4	
ATC-25	0.28 - 2.83	2.5 - 25 in-lb	1.13	2.5	79 x 95 x 83	3.13 x 3.75 x 3.25	1/4	
ATC-100	1.13 - 11.3	10 - 100 in-lb	1.13	2.5	79 x 95 x 83	3.13 x 3.75 x 3.25	1/4	
ATC-250	2.83 - 28.3	25 - 250 in-lb	1.13	2.5	79 x 95 x 83	3.13 x 3.75 x 3.25	3/8	
ATC-500	5.65 - 56.5	50 - 500 in-lb	1.13	2.5	79 x 95 x 83	3.13 x 3.75 x 3.25	3/8	
ATC-750	8.47 - 84.8	75 - 750 in-lb	1.13	2.5	79 x 95 x 83	3.13 x 3.75 x 3.25	3/8	
ATC-1000	11.3 - 113	100 - 1000 in-lb	1.13	2.5	79 x 95 x 83	3.13 x 3.75 x 3.25	3/8	
ATC-1800	21.2 - 203	188 - 1,800 in-lb	1.13	2.5	79 x 95 x 83	3.13 x 3.75 x 3.25	1/2	
<b>Horizontal Configuration</b>								
ATC-150F	20 - 200	15 - 150 ft-lb	2.25	5	79 x 95 x 83	3.13 x 3.75 x 3.25	1/2	
ATC-250F	34 - 340	25 - 250 ft-lb	2.25	5	79 x 95 x 83	3.13 x 3.75 x 3.25	1/2	
ATC-500F	68 - 678	50 - 500 ft-lb	2.25	5	79 x 95 x 83	3.13 x 3.75 x 3.25	3/4	
ATC-750F	102 - 1,017	75 - 750 ft-lb	2.25	5	79 x 95 x 83	3.13 x 3.75 x 3.25	3/4	



# Auditor Bench-Mount Testers



AUET



AUET/MTM



AUET/MTM-DC

## AUDITOR UNIVERSAL ELECTRONIC TESTERS

Auditor Universal Electronic Testers (AUET) have a broad range of features to accommodate most requirements. They are designed to be bench-top mounted and are available in several configurations and various single or multiple torque ranges. Onboard memory allows you to capture 999 torque event readings. The testers are also available in file capability (DC) models that require PC software Auditor Tool Manager (ATM).

Instruments up to 1,000 in-lb are supplied with rundown adapters/joint kits. Rundown kits for larger instruments can be ordered separately. AUET/MTM units are supplied with an external transducer port and selector switch for connecting additional transducers.

AUET testers utilize the same transducers as the ATC instruments, providing the same high quality accuracy and durability. The common interface makes the Auditor tester extremely user friendly.



### AUET Single Transducer Models

Model*	Recommended Torque Range	
	KGF-CM/NM	IN-OZ/IN-LB
AUET-050(-DC)	0.4 - 3.6 kgf-cm	5 - 50 in-oz
AUET-0100(-DC)	0.7 - 7.2 kgf-cm	10 - 100 in-oz
AUET-10(-DC)	1.1 - 11.5 kgf-cm	1 - 10 in-lb
AUET-50(-DC)	0.5 - 5.6 Nm	5 - 50 in-lb
AUET-100(-DC)	1.1 - 11.3 Nm	10 - 100 in-lb
AUET-250(-DC)	2.8 - 28.3 Nm	25 - 250 in-lb
AUET-500(-DC)	5.7 - 56.5 Nm	50 - 500 in-lb
AUET-1000(-DC)	11.3 - 113 Nm	100 - 1,000 in-lb
AUET-1200(-DC)	13.6 - 135.6 Nm	120 - 1,200 in-lb
AUET-1800(-DC)	20.3 - 203.4 Nm	180 - 1,800 in-lb

\* Add "-DC" to part numbers for data collecting models.

Data collecting models allow multiple files/tools/applications to be associated with torque data. Requires Tool Manager software.

Custom sizes are also available. Contact an AIMCO Customer Service Associate for ordering options, 1-503-254-6600, or toll free 1-800-852-1368.

### AUET/MTM Dual Transducer Models

Model**	Recommended Torque Range			
	Transducer 1	Transducer 2	Transducer 1	Transducer 2
AUET/MTM-050-25	0.04 - 0.4 Nm	0.3 - 2.8 Nm	5 - 50 in-oz	2.5 - 25 in-lb
AUET/MTM-050-600	0.04 - 0.4 Nm	6.8 - 67.8 Nm	5 - 50 in-oz	60 - 600 in-lb
AUET/MTM-0100-050	0.07 - 0.71 Nm	0.04 - 0.4 Nm	10 - 100 in-oz	5 - 50 in-oz
AUET/MTM-10-100	0.11 - 1.12 Nm	1.3 - 11.3 Nm	1.0 - 10 in-lb	10 - 100 in-lb
AUET/MTM-50-250	0.56 - 5.65 Nm	2.8 - 28.3 Nm	5.0 - 50 in-lb	25 - 250 in-lb
AUET/MTM-50-500(-DC)	0.56 - 5.65 Nm	5.7 - 56.5 Nm	5.0 - 50 in-lb	50 - 500 in-lb
AUET/MTM-50-1000(-DC)	0.56 - 5.65 Nm	11.3 - 113 Nm	5.0 - 50 in-lb	100 - 1,000 in-lb
AUET/MTM-100-500	1.13 - 11.3 Nm	5.7 - 56.5 Nm	10 - 100 in-lb	50 - 500 in-lb
AUET/MTM-100-1000	1.13 - 11.3 Nm	11.3 - 113 Nm	10 - 100 in-lb	100 - 1,000 in-lb
AUET/MTM-100-1200	1.13 - 11.3 Nm	13.6 - 135.6 Nm	10 - 100 in-lb	120 - 1,200 in-lb
AUET/MTM-100-1600(-DC)	1.13 - 11.3 Nm	18.1 - 180.8 Nm	10 - 100 in-lb	160 - 1,600 in-lb
AUET/MTM-100-2000	1.13 - 11.3 Nm	22.6 - 226 Nm	10 - 100 in-lb	200 - 2,000 in-lb
AUET/MTM-250-1600	2.82 - 28.2 Nm	18.1 - 180.8 Nm	25 - 250 in-lb	160 - 1,600 in-lb
AUET/MTM-250-1800	2.82 - 28.2 Nm	20.3 - 203.4 Nm	25 - 250 in-lb	180 - 1,800 in-lb
AUET/MTM-250-2500	2.82 - 28.2 Nm	28.2 - 282.5 Nm	25 - 250 in-lb	250 - 2,500 in-lb
AUET/MTM-500-1200	5.7 - 56.5 Nm	13.6 - 135.6 Nm	50 - 500 in-lb	120 - 1,200 in-lb
AUET/MTM-500-2500(-DC)	5.7 - 56.5 Nm	28.2 - 282.5 Nm	50 - 500 in-lb	250 - 2,500 in-lb

Custom sizes are also available. Contact an AIMCO Customer Service Associate for ordering options, 1-503-254-6600, or toll free 1-800-852-1368.

# Auditor Torque Measurement Analyzers

## Torque Measurement: Analyzers

### Features and Benefits

- Auditor Torque Analyzers share similar features across all products and are designed for intuitive and functional usability.
- Connects to AIMCO's line of rotary and stationary transducers



	ATDA	ATDA-DC
Auditor Torque Data Analyzer		Auditor Torque Data Analyzer with Data Collection
	Portable analyzer to be connected to various transducers	Portable analyzer to be connected to various transducers. Provides data collection capability with included software to interface with PC
Bi-directional	X	X
Data Output to PC	X	X
External Transducer Port	1	1
Number of stored readings	999	999
Rechargeable NiMH Battery	X	X
Digital I/O for external devices	X	X
Measurement Modes	X	X
Peak	X	X
First Peak (Click)	X	X
Pulse	X	X
Track	X	X
Measurement Units	8	8
Software Included		X

### Used In Conjunction With

#### Transducers

AISI / AISF - Analog	X	X
AISI / AISF - Digital		
ASTIS - Stationary	X	X
ARTIS - Rotary	X	X

#### Wrenches

ATW	X	X
-----	---	---

#### Switch boxes for External Transducers

AISWT-4L > 4 Way Intellect box	X	X
AISWT-6L > 6 Way Intellect box	X	X

#### Cables

ICBL-USB - USB Serial > PC	X	X
ATDBLIS - IS Transducer w/ angle (10 Pin)	X	X
ATDBRIS - IS Transducer (4 Pin)	X	X
ICBL-10P - Intellect transducer cable. Identification chip in cable - 10 pin connector	X	X
ICBL-4P - Intellect transducer cable. Identification chip in cable - 4 pin connector	X	X
ICBL-5000L - Connect from AUET/MTM & ATDA to Intellect Transducer, Analog AISI / AISF	X	X

# Auditor Torque Data Analyzers



ATDA-DC

## AUDITOR TORQUE DATA ANALYZERS

The Auditor Torque Data Analyzer (ATDA) DC is designed to be portable or conveniently placed on a bench. The tester can be connected to various transducers, as well as transducerized wrenches and rotary or stationary transducers. The user interface is common between the ATC (Cube), AUET, AUET-DC, AUET/MTM, AUET/MTM-DC, ATDA, and ATDA-DC. All of these instruments have similar menus. Additionally, all data collector testers utilize Auditor Tool Manager for tool testing and data management.

The Auditor Torque Data Analyzer is available in two configurations:

- ATDA: A simple torque analyzer with sequential memory, 999 data samples, engineering limits, limited statistical processing average, range, Cp and CpK with serial output
- ATDA-DC: Contains all of the features of the ATDA and has additional file capability. It can associate data with file names and manage data collection with a computer and Auditor Tool Manager software

This is a great “starter” tool management system. It provides testing, archiving, and analysis of tools at single or multiple torque targets. The tool and torque data is stored in a SQL database and can be exported to Excel or any .csv spreadsheet.



### ATDA Auditor Torque Data Analyzer Models

MODEL	DESCRIPTION
ATDA	Auditor Torque Data Analyzer
ATDA-DC	Auditor Torque Data Collector

The Auditor logo features the word 'AUDITOR' in a bold, italicized, sans-serif font. Above the letter 'O' is a stylized graphic of a wrench head, consisting of three horizontal lines of varying lengths, suggesting the open end of a wrench.

# Auditor Data Collection Software

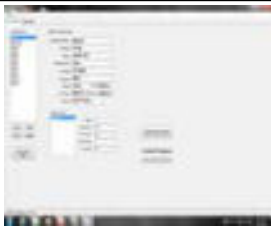
## Data Collection Software

		
<b>Auditor Tool Manager Software</b>	<b>Auditor Audit Manager Software</b>	<b>SMD Tools Software</b>
Test, verify, and archive tools	Comprehensive statistical analysis, data archiving, and data export	Use a PC as a torque tester/display for testers and transducers
Create a database of tools and store test results with easy-to-use software integrator to/from tester to PC	Facilitate residual auditing with digital wrenches and transducerized wrenches	Comprehensive, pre-configured, and guided testing of specific tools as well as manual testing with all testing parameters adjustable and set by the user

## Compatibility

Desktop or PC			X
ATC			X
ADW		X	
ATDA			X
ATDA-DC	X	X	
AUET			X
AUET-DC	X	X	
AUET/MTM			X
AUET/MTM-DC	X	X	
ARTIS			
ARTIS-DIG			X
AISI/AISF			
AISI/AISF (Digital)			X
iTVC Torque Cart			X

## AUDITOR TOOL MANAGER SOFTWARE

Tool Manager Software is included with the purchase of AUET-DC and AUET/MTM-DC data-collecting torque testers, as well as the ADW-DC data-collecting torque wrench. Create a database of tools and store test results with this easy-to-use software integrator to/from tester to PC.

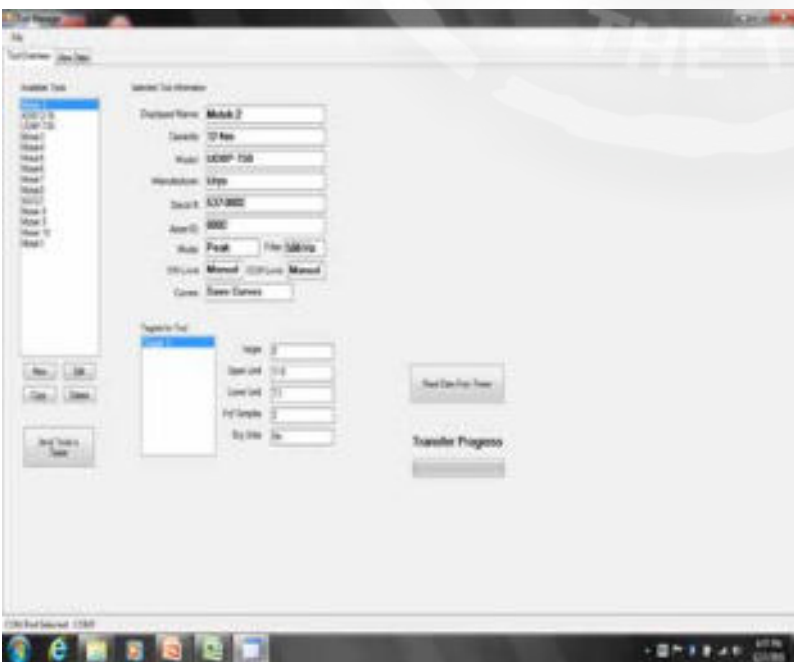

Tool Manager Software, Tool Overview Screen

# Auditor Data Collection Software

## AUDITOR AUDIT MANAGER SOFTWARE

Audit Manager Software is included with the purchase of ATDA-DC data collecting torque analyzers. The View Data tab allows you to look at the collected data and the trace file. This data can be exported to Excel as a .csv file and displayed by Excel charts. The trace file displays the data in a torque/time graph and allows the user to supersede the move-on reading selected by the wrench by visually discerning via the trace where the fastener started to rotate. When selecting a single job the average, range, sigma, Cp, and CpK values are listed.

Audit Manager Software,  
Job and Route Builder Screen

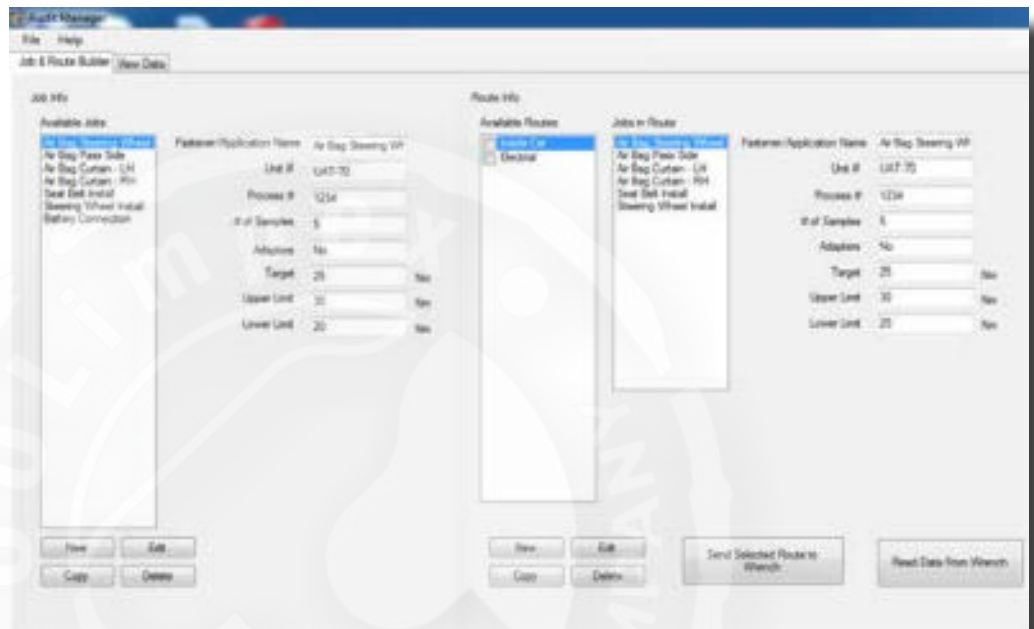

## SMD TOOLS SOFTWARE

A digital signal between a PC and a digital transducer allows SMD Tools software to operate independently of a tester or analyzer to collect and store data in Microsoft Excel.

Tool Manager and Test Manager databases within the software stores tool details and test processes for easy access in the Cert Manager platform

Auditor branded analyzers and testers can network with this software to produce and store real-time data



SMD Tools Software, Cal Cert Screen

# Auditor High-Capacity Test Stands

## Torque Measurement: High Capacity Test Stands

### Features and Benefits

- Advanced test stations for larger tools and higher torque output
- Configured to meet application requirements
- Durable industrial grade devices



	AHCTS	AHCTS-K	AHCTS	AIMTS
	Auditor High Capacity Test Stand	Auditor High Capacity Test Stand - Hydraulic	Auditor High Capacity Test Stand Dual Transducer	Auditor High Capacity Impact Test Stand
	Designed for testing tools with continuous rotating output spindles and pulse tools.	Specifically designed for hydraulic wrenches testing.	Two transducers, one for rotary tools and one for hydraulic tools. Includes rundown & reaction fixtures with a single display.	Ideal for testing impact wrenches and is recommended to utilize rundown fixtures when testing impacts.
Capacity	6,750 Nm	33,750 Nm	33,750 Nm	2,700 Nm

## Accessories

### Rundown fixtures

	AHCTS	AHCTS-K	AHCTS	AIMTS
AHCTS-3/4RDF	X		X	
AHCTS-1RDF	X		X	
AHCTS-1.5RDF	X		X	

## Adapters

	AHCTS	AHCTS-K	AHCTS	AIMTS
<b>Square to Square Drive Adapters*</b>				
	CA1510 1-1/2" Male to 1" Female	X		X
	CA1550 1-1/2" Male to 1/2" Female	X		X
	CA1575 1-1/2" Male to 3/4" Female	X		X
<b>Insert Adapters*</b>				
	CA2510I 2-1/2" Male to 1" Female	X	X	X
	CA2515I 2-1/2" Male to 1-1/2" Female	X	X	X
	CA2575I 2-1/2" Male to 3/4" Female	X	X	X
<b>Square to Hex Drive Adapters*</b>				
	CA150108DHD 1-1/2" Male to 1-1/2" Male Hex		X	

\* Partial List. Contact An Aimco Customer Service Associate For More Options, 1-503-254-6600, Or Toll Free 1-800-852-1368.

# Auditor High-Capacity Test Stands



AHCTS-5000

## AHCTS TEST STAND FOR ROTATING TOOLS

Designed for testing tools with continuous rotating output spindles. The test stand includes a rundown fixture, bushing for side load support, reaction post or reaction paddles, transducer and torque analyzer display.

### AHCTS Test Stand Models

Model	Description
AHCTS-0500	3/4" Square Drive w/rundown fixture
AHCTS-2500	1.5" Square Drive w/rundown fixture
AHCTS-5000	1.5" Square Drive w/rundown fixture
AHCTS-7500	1.5" Square Drive w/rundown fixture

Please refer to Configuration Options on the following page for required ordering options.

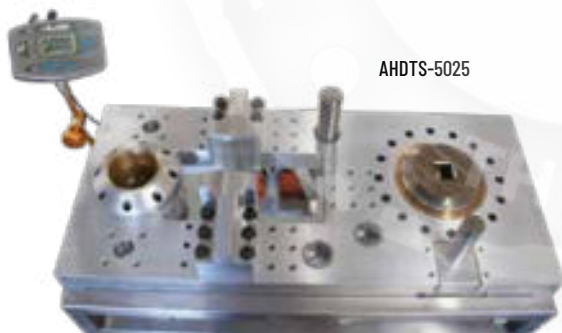

AHCTS-5025

## AHCTS DUAL TEST STAND FOR ROTATING AND HYDRAULIC TOOLS

This stand has two transducers embedded into the base, one for rotary tools and one for hydraulic tools. It comes with rundown and reaction fixtures and one display.

### AHCTS Dual Test Stand Models

Model	Description
AHCTS-5025	1.5" Sq Dr dual station w/rundown fixture and reaction devices

Contact an AIMCO Customer Service Associate for ordering options, 1-503-254-6600, or toll free 1-800-852-1368.



AHCTS-001K

## AHCTS-K STAND FOR HYDRAULIC TOOLS

The AHCTS-K stands are specifically designed for hydraulic wrench testing. Hydraulic wrenches have very low profiles but very high torque output, therefore, working height must be minimized to prevent side loading which could lead to errors in data or damage to tool or reaction devices.

Either stand can be ordered with options such as extension legs, casters, embedded or attached torque analyzers with various rundown fixtures and reaction devices. Contact an AIMCO Customer Service Associate for additional information, 1-503-254-6600, or toll free 1-800-852-1368.

### AHCTS-K Test Stand Models

Model	Description	Capacity Ft-Lb
AHCTS-0.5K	3/4" Square Drive w/reaction device	500
AHCTS-001K	1" Square Drive w/reaction device	1,000
AHCTS-2.5K	1.5" Square Drive w/reaction device	2,500
AHCTS-005K	1.5" Square Drive w/reaction device	5,000
AHCTS-010K	1.5" Square Drive w/reaction device	10,000
AHCTS-025K	2" Square Drive w/reaction device	25,000

Please refer to Configuration Options on following page for required ordering options.

Optional Pelican Case shown (ordered separately)



25503

# Auditor High-Capacity Test Stands

## AHCTS Series High Capacity Test Stands for Rotary and Hydraulic Tools Configuration Options

Base Model Number	Display	Legs	Base Size	Rundown Fixture Capacity (ft-lb)	Reaction Post	Casters	Articulated Arm and Mount	Digital Module
AHCTS-xxxx	1 = ATDA 2 = No Embedded Display 3 = ATDA-DC 6 = Standard Embedded Display  (1, 3, 4, 5 include articulated arm)	1 = 6" 2 = No legs (Standard) 3 = 18" 4 = Custom	0 = 8 x 8" 1 = 12 x 12" 3 = 14 x 19" (Standard) 4 = 18 x 24" 5 = 18 x 36" 6 = NA	1 = 500 2 = No 3 = 1,000 4 = 2,500 5 = 5,000 6 = 7,500 7 = 1.5" Kit Max. capacity 7,500 Ft-Lb 8 = 2.5" Kit Max. capacity 7,500 Ft-Lb	1 = Single 6" Post and Paddles 2 = No 3 = Multiple Posts 6" 4 = Paddles 5 = Custom 6 = Single 9" Post and Paddles 7 = Multiple Posts 9"	1 = Yes 2 = No	1 = Yes 2 = No	1 = Yes (for Tablet or PC direct) 2 = No
Model Number Digits 1-10	Model # Digit 11	Model # Digit 12	Model # Digit 13	Model # Digit 14	Model # Digit 15	Model # Digit 16	Model # Digit 17	Model # Digit 18

### Auditor High Capacity Test Stand for Rotary Tools

AHCTS-0500 680 Nm / 500 ft-lb			0, 1, or 3					
AHCTS-1000 1,360 Nm / 1,000 ft-lb			0, 1, or 3					
AHCTS-2500 3,400 Nm / 2,500 ft-lb			0, 1, or 3					
AHCTS-5000 6,800 Nm / 5,000 ft-lb			0, 1, or 3					
AHCTS-7500 10,200 Nm / 7,500 ft-lb			0, 1, or 3					

### Auditor High Capacity Test Stand for Hydraulic Tools

AHCTS-0.5K 680 Nm / 500 ft-lb			0-5 (3-5 come with casters)	2				
AHCTS-001K 1,360 Nm / 1,000 ft-lb			0-5 (3-5 come with casters)	2				
AHCTS-2.5K 3,390 Nm / 2,500 ft-lb			0-5 (3-5 come with casters)	2				
AHCTS-005K 6,800 Nm / 5,000 ft-lb			0-5 (3-5 come with casters)	2				
AHCTS-010K 13,600 Nm / 10,000 ft-lb			0-5 (3-5 come with casters)	2				
AHCTS-025K 34,000 Nm / 25,000 ft-lb			0-5 (3-5 come with casters)	2				
AHCTS-050K 68,000 Nm / 50,000 ft-lb			0-5 (3-5 come with casters)	2				



# Auditor High-Capacity Test Stands

## AIMTS TEST STAND FOR IMPACT TOOLS

Obtain accurate test results with the AIMTS Series Impact Test Stand. When used with an Auditor ATDA Analyzer or AUET/MTM Desktop Torque Tester, the tool's performance data can be recorded and stored. Each Auditor Analyzer comes standard with PC-based software to store and organize data for use within a quality system. It is necessary to bolt the AIMTS to a bench. We also recommend that a rundown fixture always be used for testing impacts.

### FEATURES AND BENEFITS

- Housing designed with mounting holes for bolting to bench
- Transducer designed with spline interface to rundown fixture for durability
- Rundown fixture is configurable from a "soft" joint rate to a "hard" joint rate

### AIMTS Test Stand Models

Model	Capacity		Weight		Dimensions (W x H x D)		Sq. Dr.
	FT-LB	Nm	LB	KG	IN	MM	
AIMTS-0050	5 - 50	7 - 70	10	4.5	8 x 10 x 4	203 x 254 x 102	3/4"
AIMTS-0250	25 - 250	34 - 340	10	4.5	8 x 10 x 4	203 x 254 x 102	3/4"
AIMTS-0500	50 - 500	68 - 680	10	4.5	8 x 10 x 4	203 x 254 x 102	3/4"
AIMTS-2000	200 - 2,000	271 - 2,710	16	7.3	10 x 12 x 8	254 x 305 x 203	1.5"
AIMTS-2500	250 - 2,500	340 - 3,400	16	7.3	10 x 12 x 8	254 x 305 x 203	1.5"
AIMTS-5000	500 - 5,000	678 - 6,780	16	7.3	10 x 12 x 8	254 x 305 x 203	1.5"

Refer to Configuration Options below for required ordering options.



**AIMTS-2000**  
Test stand for large impact tools



**AIMTS-0500**  
Test stand for small impact tools. ATDA-DC Torque Data Analyzer sold separately.



AIMTS Series High Capacity Impact Test Stand Configuration Options							
Base Model #	Display	Legs	Base Size	Rundown Fixture Capacity (ft-lb)*		Options	Digital Module
AIMTS-xxxx	1 = ATDA 2 = No Embedded Display 3 = ATDA-DC	1 = 6" 2 = No legs (Standard) 3 = 18" 4 = Custom	6 = Bench Stand	1 = 500 2 = No 3 = 2,000 4 = 50 5 = 5,000	6 = 10,000 7 = 20,000 8 = 250 9 = 2,500	Not available for AIMTS test stands. Enter 222 for model # digits 15-17	1 = Yes (for Tablet or PC direct) 2 = No
Model Number Digits 1-10	Model Number Digit 11	Model Number Digit 12	Model Number Digit 13	Model Number Digit 14		Model Number Digits 15-17	Model Number Digit 18
AIMTS-0050 68 Nm / 50 ft-lb		2	6	4		222	
AIMTS-0250 340 Nm / 250 ft-lb		2	6	8		222	
AIMTS-0500 680 Nm / 500 ft-lb		2	6	1		222	
AIMTS-2000 2,720 Nm / 2,000 ft-lb		2	6	3		222	
AIMTS-2500 3,390 Nm / 2,500 ft-lb		2	6	9		222	
AIMTS-5000 6,780 Nm / 5,000 ft-lb		2	6	5		222	

\* Ordering more than one rundown fixture is highly recommended if you're doing a lot of testing. Having multiple rundown fixtures ensures that you have spares when dealing with heat issues. AIMTS test stands are available in capacities of up to 20,000 ft-lb. Capacities other than what is shown here are quoted separately. Contact an AIMCO Customer Service Associate at 1-503-254-6600, or toll free 1-800-852-1368.

# Torque Wrenches

## Torque Measurement: Torque Wrenches

### Features and Benefits

- Options from Simple to Sophisticated
  - Residual or Dynamic Measuring
  - Tactile (Click) or Digital
- Connectivity
  - Auditor Devices (ATW)
  - Broad Range of Protocols (Phoenix III)
- Durable
  - Designed for Factory Floor Environments
  - Used in Production Applications or Quality Checks



#### APTW

#### ATW

#### Phoenix III

Auditor Preset Torque Wrench

Auditor Electronic Torque Wrench

Phoenix III Digital Torque Wrench

### Torque Range

5 – 340 Nm  
4 – 250 ft-lb

5 – 200 Nm  
4 – 148 ft-lb

1.5 – 1,200 Nm  
1.1 – 885 ft-lb

Interchangeable FACOM type heads. Preset uses proprietary adjustment tool to guard against unauthorized setting changes

Aka "Transducer on a Stick." Connectivity to Auditor™ testers and data analyzers

Transducerized digital torque wrench with Production and Quality functionality. Optional WiFi technology for wireless communication over Open Protocol

### Bi-Directional accuracy of +/- X of indicated reading within the top 90% of the tester's capacity

3%

0.50%

0.1%

### Software Included

X

X

X

## Used In Conjunction With

ATDA (DC) Data Analyzer

X

AUET (DC) Tester

X

AUET/MTM (DC) Tester

X

## Torque Wrench Loaders



For calibration of all types of torque wrenches, eliminating human variables for more accurate measurement.

ATWL-250

Torque range up to 340 Nm / 250 ft-lb

ATWL-750

Torque range up to 1,020 Nm / 750 ft-lb

ATWL-1000

Torque range up to 1,360 Nm / 1,000 ft-lb

# Auditor Preset Torque Wrenches

## APTW Preset Torque Wrenches

Auditor's APTW preset wrenches provide a flexible, easy way to audit fastener torque. A wide range of interchangeable heads provide flexibility and convenience.

### FEATURES AND BENEFITS



- Easy-to-use preset wrenches for fastener torque auditing
- Torque ranges from 5 – 340 Nm
- User friendly, sleek, ergonomic design
- Tactile feedback on achievement of preset torque
- Proprietary adjustment tool guards against unauthorized setting changes
- Wide range of interchangeable heads provide flexibility and convenience
- +/- 3% accuracy when used in clockwise or counterclockwise directions







### APTW Torque Wrench Models

WRENCH MODEL	TORQUE RANGE	INSERT ACCEPTED
APTW-25	5 – 25 Nm	12 mm
APTW-50	10 – 50 Nm	12 mm
APTW-100	20 – 100 Nm	12 mm
APTW-150	30 – 150 Nm	12 mm
APTW-200	40 – 200 Nm	14 mm
APTW-340	60 – 340 Nm	14 mm



### TORQUE WRENCH INSERTS



Adapters	Description
 APTH-12ADP	9 x 12 M to 14 x 18 F
 APTH-14ADP	14 x 18 M to 9 x 12 F

Ring End Inserts	Description
 APTH-12RE50	1/2" Ring End, 12 mm
 APTH-14RE32	32 mm Ring End, 14 mm

Square Drive Inserts	Description	
	9 x 12	
	APTH-12SD25	1/4" Sq. Dr.
	APTH-12SD38	3/8" Sq. Dr.
	APTH-12SD50	1/2" Sq. Dr.
	14 x 18	APTH-14SD50

Blank End Inserts	Description
 APTH-12BLANK	12 mm
APTH-14BLANK	14 mm

Ratchet Heads	Description	
	9 x 12	
	APTH-12RT25	1/4" Sq. Dr.
	APTH-12RT38	3/8" Sq. Dr.
	APTH-12RT50	1/2" Sq. Dr.
	14 x 18	APTH-14RT50
	APTH-14RT34	3/4" Sq. Dr.

Open End Head Inserts							
	Model	Description	14 x 18				
		9 x 12		14 x 18			
	APTH-120E7	7 mm OE	APTH-140E1	1" OE	APTH-140E25	25 mm OE	
	APTH-120E8	8 mm OE	APTH-140E13	13 mm OE	APTH-140E27	27 mm OE	
	APTH-120E9	9 mm OE	APTH-140E14	14 mm OE	APTH-140E30	30 mm OE	
	APTH-120E10	10 mm OE	APTH-140E15	15 mm OE	APTH-140E32	32 mm OE	
	APTH-120E11	11 mm OE	APTH-140E16	16 mm OE	APTH-140E34	34 mm OE	
	APTH-120E12	12 mm OE	APTH-140E17	17 mm OE	APTH-140E36	36 mm OE	
	APTH-120E13	13 mm OE	APTH-140E18	18 mm OE	APTH-140E38	38 mm OE	
	APTH-120E14	14 mm OE	APTH-140E19	19 mm OE	APTH-140E41	41 mm OE	
	APTH-120E15	15 mm OE	APTH-140E21	21 mm OE	APTH-140E118	1-1/8" OE	
	APTH-120E16	16 mm OE	APTH-140E22	22 mm OE	APTH-140E138	1-3/8" OE	
	APTH-120E17	17 mm OE	APTH-140E24	24 mm OE			
	APTH-120E18	18 mm OE					
	APTH-120E19	19 mm OE					
	APTH-120E20	20 mm OE					
	APTH-120E50	1/2" OE					

# Auditor Electronic Torque Wrenches

## ATW Electronic Torque Wrenches

Precise Tightening and Auditing of Your Assembly Applications

### "TRANSDUCERS ON A STICK"

- Non-Length Dependent – Where the operator's hand is positioned during use has no effect on torque readings
- Available in Industry Standard (IS) or Intelligent (Intellect) Configurations – Transducer is compatible with a wide variety of IS style instruments or Auditor Intellect instruments that self recognize the transducer
- Durable – Steel, Aluminum and Carbon Fiber construction provide optimal strength and weight. Transducer supplied with overload capacity of 150% of full scale
- Accurate – Torque readings are accurate to 1% of indicated reading in top 95% of full scale



### ATW Torque Wrench Models

Model	Torque Range		Square Drive
	NM	FT-LB	IN
ATW-0100F	14 - 136	10 - 100	3/8
ATW-0200F	27 - 272	20 - 200	1/2
ATW-0500F	68 - 680	50 - 500	3/4
ATW-1000F	136 - 1,360	100 - 1,000	1

Required Accessory: ATDBRIS IS cable to connect Auditor ATDA instrument.



# Phoenix III Digital Torque Wrenches

## Phoenix III Transducerized Digital Torque Wrench

Quality Assurance Moves to the Next Level

The Phoenix III transducerized digital torque wrench sets a new standard for quality in Production or Auditing with a hand-held wrench. With Ranges from 1.5 - 600 Nm and available options up to 1,200 Nm, the Phoenix III covers a wide range of application demands and joint analysis requirements. Optional integrated Wi-fi technology expands the possibilities of reporting in Industry 4.0 methodologies.

### FEATURES AND BENEFITS

- **Ultimate Flexibility:** Multiple Tightening Modes/Strategies
  - **Free Test Mode:** Track and Peak for testing without logging results.
  - **Two Wrenches in One: Production/QA Functionality with multiple strategies**
    - ▶ Torque Control (TC)
    - ▶ Torque Control + Angle Monitor (TC+AM)
    - ▶ Torque Control + Angle Control (TC+AC)
    - ▶ Breakaway
- **Easy Programming:** Configure Wrench through hassle-free TW Config software that is provided free of charge. Entries can be made using onboard wrench touchscreen or through connected PC
- **Industry 4.0:** Optional integrated 2.4Ghz Wi-fi module enables wireless communication over Open Protocol
- **Clear Results:** A 2.8" color display provides clear visualization of results with intuitive icons.
- Optional integrated barcode scanner module
- Wrench provides backup and restore of file settings. Data exportable in most industry-standard formats. Collected data can be reported to MSqnet software for production (MSqnet STA, TPC) and quality (MSqnet QA) applications
- 16 GB internal memory allows you to store up to 1,000,000 rundowns and traces, as well as 4,000 psets
- Li-ion 3.7V, 3,500 mAh battery provides 10 hours of continuous operation



### Phoenix III Electronic Torque Wrench

Model*	Torque Range		End Connector	Length (minus insert)		Weight	
	Nm	Ft-Lb		mm	in	kg	lb
Phoenix III-15nm	1.5 - 15	1.1 - 11	9x12	426	16.8	0.95	2.1
Phoenix III-30nm	3 - 30	2.2 - 22	9x12	426	16.8	0.95	2.1
Phoenix III-70nm	7 - 70	5.2 - 52	9x12	488	19.2	1.00	2.2
Phoenix III-100nm	10 - 100	7.4 - 74	9x12	488	19.2	1.03	2.3
Phoenix III-200nm	20 - 200	14.8 - 148	14x18	615	24.2	1.57	3.5
Phoenix III-300nm	30 - 300	22 - 220	14x18	765	30.1	1.69	3.7
Phoenix III-400nm	40 - 400	29.5 - 295	14x18	866	34.1	1.89	4.2
Phoenix III-600nm	60 - 600	44.3 - 443	14x18	1,050	41.3	2.02	4.5

\* Common models shown. Models with capacity up to 1,200 Nm (885 ft-lb) available by request



# iTVC Torque Cart



AIMCO's iTVC Torque Cart is designed for "lineside" or "point of use" tool validation and calibration. Our torque carts allow testing of tools on repeatable joint simulators and "in process" use on production joints, allowing users to identify process capability. Multiple torque cart configurations are available with simple to sophisticated options:

- Manual push carts equipped with simple torque testers
- Manual push carts equipped with data collectors and database application software
- Self propelled cart with computer and relational database application
- Driven cart with computer and relational database application



## FEATURES AND BENEFITS

- For testing on repeatable joint simulators or actual production joints
- Mobile test carts can be configured for testing continuous and discontinuous drive tools, including DC electric, clutch, battery, impulse, and torque wrenches
- Each cart is customizable to meet testing needs from 1 – 1,400 Nm
- Data management software options are available to suit specific audit or asset-tracking needs
- Torque wrench loaders are configurable to suit wrench populations

Carts can be equipped to specific customer requirements. Ancillary test stands up to 50,000 ft-lb available. Contact an AIMCO Customer Service Associate for a quote or for more details, 1-503-254-6600, or toll free 1-800-852-1368.



	Model	Description	Low Torque		High Torque			
			NM	FT-LB	NM	FT-LB		
UFT	Mobile-Powered							
	iTVC.A	Torque Cart, UFT Mobile Base #						
	iTVC.A2XXXXXX	NO JOINTS	0	0	0	0		
	iTVC.A2XBCXXX	2 UFTs	15	11	190	140		
	iTVC.A2XBCDXX	3 UFTs	15	11	686	506		
	iTVC.A2ABCDXX	4 UFTs	1	0.7	686	506		
	iTVC.A2ABCDEP	4 UFTs, 1 AJKR, Printer	1	0.7	1,400	1,033		
	Manual							
	iTVC.A1XXXXXX	Torque Cart, UFT Manual Base #						
	iTVC.A1XBCXXX	2 UFTs	15	11	190	140		
	iTVC.A1XBCDXX	3 UFTs	15	11	686	506		
	iTVC.A1ABCDXX	4 UFTs	1	0.7	686	506		
iTVC.A1ABCXEX	3 UFTs, 1 AJKR	1	0.7	1,400	1,033			
iTVC.A1ABCDEP	4 UFTs, 1 AJKR	1	0.7	1,400	1,033			
AJKR	Mobile-Powered							
	iTVC.B2XXXXX	Torque Cart, AJKR Mobile Base #						
	iTVC.B2XBCXX	2 joints	27	20	271	200		
	iTVC.B2XBCEX	3 joints	27	20	1,400	1,033		
	iTVC.B2ABCPEP	4 joints	6	4.4	1,400	1,033		
	Manual							
	iTVC.B1XXXXX	Torque Cart, AJKR Manual Base #						
	iTVC.B1XBCXX	2 joints	27	20	271	200		
iTVC.B1XBCEX	3 joints	27	20	1,400	1,033			
iTVC.B1ABCPEP	4 joints	6	4.4	1,400	1,033			
BASE	Mobile-Powered							
	iTVC.X2X	Cart, no computer	–	–	–	–		
	iTVC.X2A	Cart, w/computer	–	–	–	–		
	Manual							
iTVC.X1X	Cart, no Computer	–	–	–	–			
iTVC.X1A	Cart, w/Computer	–	–	–	–			

# Transducers



## Torque Measurement: Transducers

### Features and Benefits

Superior:

- Accuracy
- Compatibility
- Durability

Auditor offers multiple styles of transducers in various configurations. Industry standard transducers (2mv/v) and intellect transducers for Auditor instruments that reduce configuration set up time.

	Rotary	Stationary	
			
	<b>ARTIS</b>	<b>ASTIS</b>	<b>AISI - AISF*</b>
	Auditor Rotary Transducer Industry Standard	Auditor Stationary Transducer Industry Standard	Auditor Industry Standard Stationary

### Used in Conjunction with Analyzer

AUET	X		
AUET/MTM	X	X	X
ATDA	X	X	X

\* See Configuration Options on following page to configure complete part number for AISI / AISF models. Please contact an AIMCO Customer Service Associate for additional information, 1-503-254-6600, or toll free 1-800-852-1368.

## AUDITOR ROTARY TRANSDUCERS

Suitable for use with all continuous drive tools, impulse tools and torque wrenches.



ARTIS Series

Model	Drive IN	Max Torque		Weight LB
		NM	IN-LB/FT-LB	
ARTIS-25H-2T(A)	1/4 Hex	2	18 in-lb	1.0
ARTIS-25H-5T(A)	1/4 Hex	5	44 in-lb	1.0
ARTIS-25H-10T(A)	1/4 Hex	10	88 in-lb	1.0
ARTIS-25H-20T(A)	1/4 Hex	20	180 in-lb	1.0
ARTIS-25S-10T(A)	1/4 Sq.	10	88 in-lb	1.0
ARTIS-25S-20T(A)	1/4 Sq.	20	180 in-lb	1.0
ARTIS-38S-25T(A)	3/8 Sq.	25	225 in-lb	1.2
ARTIS-38S-75T(A)	3/8 Sq.	75	50 ft-lb	1.2
ARTIS-50S-180T(A)	1/2 Sq.	180	130 ft-lb	1.5
ARTIS-75S-250T(A)	3/4 Sq.	250	180 ft-lb	2.2
ARTIS-75S-500T(A)	3/4 Sq.	500	370 ft-lb	2.2
ARTIS-100S-750T(A)	1 Sq.	750	553 ft-lb	4.0
ARTIS-100S-1400T(A)	1 Sq.	1400	1,025 ft-lb	4.0

\*Add "A" to the end of the part number to indicate torque/angle transducer.

# AUDITOR™

# Transducers

## AUDITOR STATIONARY TRANSDUCERS

Stationary Transducers with joint rundown fixtures and, where applicable, bench stands.



ASTIS

ASTIS industry standard transducers can be used with multiple analyzers.

### ASTIS Transducers

Model	NM	Max Torque		Drive IN
		IN-LB/FT-LB		
ASTIS-25D-11	11	100 in-lb		1/4
ASTIS-25D-28	28	250 in-lb		1/4
ASTIS-38D-135	135	100 ft-lb		3/8
ASTIS-50D-270	270	200 ft-lb		1/2
ASTIS-75D-1000	1017	750 ft-lb		3/4
ASTIS-100D-1700	1,695 Nm	1,250 ft-lb		1



AISI

AISI / AISF Transducers connect to the AUET/MTM and ATDA analyzers and mount directly to a benchtop.

### AISI & AISF Transducers

Model*	Max Torque		Weight		W X H X D		Drive IN
	NM	IN-LB/FT-LB	KG	LB	MM	IN	
AISI-200025	2.8	25 in-lb	1.13	2.5	79 x 95 x 83	3.13 x 3.75 x 3.25	1/4
AISI-200100	11.3	100 in-lb	1.13	2.5	79 x 95 x 83	3.13 x 3.75 x 3.25	1/4
AISI-200500	56.5	500 in-lb	1.13	2.5	79 x 95 x 83	3.13 x 3.75 x 3.25	3/8
AISF-200100	135.6	100 ft-lb	2.25	5	100 x 65	4 x 3	1/2
AISF-200250	339	250 ft-lb	2.25	5	100 x 65	4 x 3	1/2
AISF-201000	1,350	1,000 ft-lb	2.8	6	100 x 65	4 x 3	1

\* See Configuration Options below to configure complete part number for AISI / AISF models.

### Auditor AISI / AISF Industry Standard Transducers Configuration Options

Base Model #	Angle	Capacity	Configuration	Expanded Range*	Digital	Drive Size	Wireless
Model # Digits 1-5	2 = No	00025 = 25 In-Lb / 25 Ft-Lb 00050 = 50 In-Lb / 50 Ft-Lb 00100 = 100 In-Lb / 100 Ft-Lb 00250 = 250 In-Lb / 250 Ft-Lb 00350 = 350 In-Lb / 350 Ft-Lb 00500 = 500 In-Lb / 500 Ft-Lb 00600 = 600 In-Lb / 600 Ft-Lb 00750 = 750 In-Lb / 750 Ft-Lb 01000 = 1,000 In-Lb / 1,000 Ft-Lb	1 = Bench Stand 2 = Inline 3 = Loader (1000 Series Only)	1 = Yes 2 = No	1 = Yes 2 = No	1 = 1/4" Hex (up to 100 In-Lb / 8.3 Ft-Lb) 2 = 1/4" Sq. (up to 100 In-Lb / 8.3 Ft-Lb) 3 = 3/8" Sq. (150-500 In-Lb / 12.5-41.7 Ft-Lb) 4 = 1/2" Sq. (1,800-3,000 In-Lb / 150-250 Ft-Lb) 5 = 3/4" Sq. (3,000-12,000 In-Lb / 250-1,000 Ft-Lb) 6 = 1" Sq. (12,000-24,000 In-Lb / 1,000-2,000 Ft-Lb) 7 = 1-1/2" Sq. (24,000+ In-Lb / 2,000+ Ft-Lb)	2 = No
Model # Digits 1-5	Model # Digit 6	Model # Digits 7-11	Model # Digit 12	Model # Digit 13	Model # Digit 14	Model # Digit 15	Model # Digit 16
Stationary							
AISI- (in-lb capacities)	2						2
AISF- (ft-lb capacities)	2						2

\*Standard range is 10%-100% of maximum capacity. Expanded range is 5%-100% of maximum capacity.

Transducers are available in capacities of up to 10,000 Ft-Lb. Contact an AIMCO Customer Service Associate at 1-503-254-6600, or toll free 1-800-852-1368.



# Rundown Fixtures

## Torque Measurement: Rundown Fixtures

### Features and Benefits

- Enables accurate and repeatable testing of pneumatic or electric power tools
- Mechanical Belleville system of bolt, nut or nut body, Belleville washers and main housing, 1/4" - 3/4" drive sizes, 10 in-lb - 1,200 ft-lb
- Fixtures can be ordered to simulate hard, med., or soft joints



	ARDFA-XXXXHD ARDIA-XXXHD	ARDFA-XXXHDS ARDIA-XXXHDS	ARDFA-XXXHDE ARDIA-XXXHDE	ARDFA-XXX ARDIA-XXX
Wear-Resistant Heavy Duty	X			
Heavy Duty, Fully Encapsulated		X		
Heavy Duty, Encapsulated Washers			X	
Standard (Included w/analyzer)				X
Spline Drive				
Used in Conjunction with External Transducer				
ASTIS	X	X	X	X
AISI / AISF	X	X	X	X
ARTIS	X	X	X	X

\*Spline drive feature provides rundown control when testing pulse tools.



## AUDITOR RUNDOWN FIXTURES

To test power tools, pneumatic or electric, consistent rotational speed must be achieved. The joint rundown fixture/simulator provides the means by which the tool motor and spindle rotates freely at the start of the test cycle and then develops torque as rotation resistance increases as fastener/joint load increases. The linearity and consistency of the joint rundown fixtures/simulators vary greatly and the tool test data is a product of the variations in these rundown fixtures. Higher quality joint rundown fixtures produce torque data with less scatter.

## ARDIA Models

Model*	Recommended Torque Range		Square Drive
	NM	IN-LB	
ARDIA-10(HD)(HDE)(HDS)	.13 - 1.13	1.0 - 10	1/4"
ARDIA-25(HD)(HDE)(HDS)	.28 - 2.8	2.5 - 25	1/4"
ARDIA-50(HD)(HDE)(HDS)	.56 - 5.6	5 - 50	1/4"
ARDIA-100(HD)(HDE)(HDS)	1.3 - 11.3	10 - 100	1/4"
ARDIA-150(HD)(HDE)(HDS)	1.7 - 16.9	15 - 150	1/4"
ARDIA-250(HD)(HDE)(HDS)	2.8 - 28.3	25 - 250	3/8"
ARDIA-350(HD)(HDE)(HDS)	4 - 40	35 - 350	3/8"
ARDIA-500(HD)(HDE)(HDS)	5.6 - 56.5	50 - 500	3/8"
ARDIA-750(HD)(HDE)(HDS)	8.5 - 84.7	75 - 750	3/8"
ARDIA-1000(HD)(HDE)(HDS)	11.3 - 113	100 - 1,000	3/8"

\*Add "HD" to part numbers for wear resistant models. Add "HDS" to part numbers for fully encapsulated wear resistant models.

\*Add "HDE" to part numbers for partial encapsulated wear resistant models.

## ARDFA Models

Model*	Recommended Torque Range		Square Drive
	NM	FT-LB	
ARDFA-100(HD)(HDE)(HDS)	13.6 - 136	10 - 100	1/2"
ARDFA-150(HD)(HDE)(HDS)	20.4 - 204	15 - 150	1/2"
ARDFA-250(HD)(HDE)(HDS)	34 - 340	25 - 250	1/2"
ARDFA-500(HD)(HDE)(HDS)	67.8 - 678	50 - 500	3/4"
ARDFA-600(HD)(HDE)(HDS)	81.6 - 816	60 - 600	3/4"
ARDFA-750(HD)(HDE)(HDS)	101.7 - 1,017	75 - 750	3/4"

\* Add "HD" to part numbers for wear resistant models. Add "HDS" to part numbers for encapsulated wear resistant models.

\* Add "HDE" to part numbers for partial encapsulated wear resistant models.



# Joint Kits / Joint Simulators

## JOINT KITS

Joint kits are an essential accessory for accurate off-line testing of powered assembly tools.

- Represent production joint conditions off the production line
- Can be adjusted to include joint conditions specified by ISO 5393
- Allows free running of bolt before torque gradient
- Provide linear response. Repeatable 1/4" - 1" drive sizes, 28 - 1,695 Nm.

## AJKR & AJKS Joint Kits

Rotary Kit*	Model	Drive Size - IN
	AJKR-28	1/4
	AJKR-135	3/8
	AJKR-271	1/2
	AJKR-1017	3/4
	AJKR-1695	1
Stationary Kit**	Model	Drive Size - IN
	AJKS-25D	1/4
	AJKS-38D	3/8
	AJKS-50D	1/2
	AJKS-75D	3/4
	AJKS-100D	1

\* AJKR for use with ARTIS external transducers.

\*\*AJKS for use with ASTIS or ARTIS external transducers.

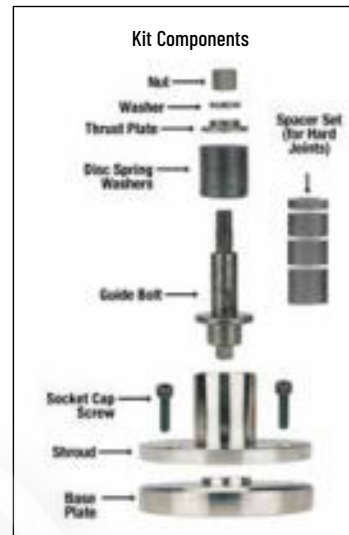

## UFT SERIES HYDRAULIC MECHANICAL JOINT SIMULATORS



- Designed for pulse tool and continuous drive tool certification and testing, UFT Joint Simulators offer the most repeatable and linear joint rate simulation on the market
- For use with ARTIS external transducers
- Bolt tightening body and hydraulic pressure loading mechanism are connected by a hydraulic pressure circuit. Ideal for ISO 5393 test procedures
- Quickly and easily simulate three joint rates by opening or closing two external valves
- Specially coated testing bolt produces over 100,000 cycles without variation or deformation

## UFT Joint Simulators

Model	Bolt Size	Torque Range		Weight	
		NM	FT-LB	LB	KG
UFT-6	M5	3.2 - 5.4	2 - 4	8	3.6
	M6	5.4 - 14.7	4 - 11		
	M8	14.7 - 31.4	11 - 23		
UFT-10 / UFT-S10	M6	6.7 - 14.7	5 - 11	43	19.5
	M8	14.7 - 31.4	11 - 23		
	M10	31.4 - 53.9	23 - 40		
UFT-16 / UFT-S16	M12	53.9 - 88.2	40 - 65	88	40
	M14	88.2 - 149	65 - 110		
	M16	149 - 190	110 - 140		
UFT-24*	M18	190 - 294	140 - 217	108	49.1
	M20	294 - 441	217 - 325		
	M24	441 - 686	325 - 506		

\* UFT-24 medium hard/soft joints only

Reaction fixture for continuous drive tools not included. Sockets included.

# Torque Measurement Cables



## Torque Measurement Cables

Model	Description	Serial Cable	Transducer Cable	Rotary	Rotary W/Angle	Stationary	Ind Std	Intellect
ICBL-USB*	Connects between COM port of display to PC	X						
ATDBLIS*	Connect to IS transducer w/ angle - 10 pin		X		X		X	
ATDBRIS*	Connect to IS transducer - 4 pin		X	X		X	X	
ICBL-10P*	Intellect transducer cable. Identification chip in cable - 10 pin connector		X		X			X
ICBL-4P*	Intellect transducer cable. Identification chip in cable - 4 pin connector		X	X		X		X
ICBL-5000L	Connect from AUET/MTM & ATDA to Intellect Transducers, Analog AISI / AISF		X			X		X
ICBL-8000DIG	Connect PC to digital transducers through digital module		X					

\* Compatible with ATDA, AUET, ADW products

## Tester / Analyzer Compatibility

Model	ATC	AUET	AUET/MTM	AUET-DC	AUET/MTM-DC	ATDA	ATDA-DC	AISWT Switchbox	ADW	ADW-DC	AIMTS Test Stand
ICBL-USB	X	X	X	X	X	X	X		X	X	
ATDBLIS		X	X	X	X	X	X				
ATDBRIS		X	X	X	X	X	X				
ICBL-10P		X	X	X	X	X	X				
ICBL-4P		X	X	X	X	X	X				
ICBL-5000L			X		X	X	X	X			X
ICBL-8000DIG											X

## Transducer Compatibility

Model	Stationary			Rotary
	ASTIS	Analog AISI/AISF	Digital AISI/AISF	ARTIS
ATDBLIS				X
ATDBRIS	X			X
ICBL-10P				X
ICBL-4P				X
ICBL-5000L		X		
ICBL-8000DIG			X	

# AcraDyne High Torque Pneumatic Tools

## FEATURES AND BENEFITS

AcraDyne's High Torque Pneumatic Bolting Tools offer a reliable and dependable solution for the installation and removal of heavy-duty fasteners. Appropriate for use in industries requiring high torque capability, accuracy, power, and safety.

- Modular design allows for ease of maintenance
- Interchangeable motors and gearing
- Same proven and reliable gearbox as the AcraDyne DC line
- One-hand reverse



AAP1B66600A



AAP1B76950A



AAP1B772000A



AAP1B885100A



## AAP1B Series Tools

Model	Torque		Speed (RPM)	Weight (LB)	Square Dr. (IN)	Air Consumption (CFM)
	(NM)	(FT-LB)				
AAP1B66400A	400	300	57	9.75	3/4	22.9
AAP1B66600A	600	450	39	9.75	3/4	22.9
AAP1B66850A	850	625	27	9.75	3/4	22.9
AAP1B76950A	950	700	31	10.4	3/4	26.3
AAP1B771350A	1,350	1,000	22	10.4	1	26.3
AAP1B772000A	2,000	1,475	14	12.7	1	26.3
AAP1B772950A	2,950	2,175	9	14.9	1	26.3
AAP1B885100A	5,100	3,775	8	23	1-1/2	31.5

## AIR PREPARATION UNITS

Many stacking filter/regulator combinations are available. See page 157 for options.

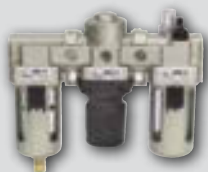

AFRL-4



AFRL-4HTA Standalone Unit

28178 HT Air Tool/AFRL Carrying Kit



Maximum allowable Input Pressure not to exceed 120 PSI.

# AcraDyne High Torque, High Speed Pneumatic Tools

Our High-Torque, High-Speed Pneumatic Bolting Tools offer a reliable and dependable solution for the installation and removal of heavy-duty fasteners with high torque capability, accuracy, power, and safety.

## FEATURES AND BENEFITS

- Dual motor design provides extremely fast rundown speed
- Improved torque to weight ratio
- Full swivel gearcase facilitates reaction bar positioning for ease of use and operator comfort
- Handle exhaust with low sound level
- Uses the same durable and reliable gearbox from our DC line of high torque tools
- Modular design allows for easy maintenance
- Two-piece handle construction enables flexible handle design
- Available in reversible and non-reversible models



## AAP2B Series Tools

Model	Torque		Speed (RPM)	Weight		Length		Square Dr. (IN)
	(NM)	(FT-LB)		(LB)	(KG)	(IN)	(MM)	
AAP2B76250A	250	185	660	10.5	4.8	10	255	3/4
AAP2B76450A	450	330	335	10.5	4.8	10	255	3/4
AAP2B76650A	650	480	223	10.5	4.8	10	255	3/4
AAP2B76950A	950	700	153	10.5	4.8	10	255	3/4
AAP2B771400A	1,400	1,000	110	14.6	6.6	10	255	1
AAP2B772000A	2,000	1,475	63	14.8	6.7	11.2	284	1
AAP2B773000A	3,000	2,210	52	15.0	6.8	11.6	293	1
AAP2B785100A	4,800	3,540	26.5	19.7	8.9	13.3	338	1.5

## AAP2B Series Reversible Tools

Reversible Model	Torque		Speed (RPM)	Weight		Length		Square Dr. (IN)
	(NM)	(FT-LB)		(LB)	(KG)	(IN)	(MM)	
AAP2B76250AR	250	185	660	12.3	5.6	12.5	317	3/4
AAP2B76450AR	450	330	335	12.3	5.6	12.5	317	3/4
AAP2B76650AR	650	480	223	12.3	5.6	12.5	317	3/4
AAP2B76950AR	950	700	153	12.3	5.6	12.5	317	3/4
AAP2B771400AR	1,400	1,000	110	16.4	7.4	12.6	319	1
AAP2B772000AR	2,000	1,475	63	16.6	7.5	13.6	346	1
AAP2B773000AR	3,000	2,210	52	16.8	7.6	14.0	356	1
AAP2B785100AR	4,800	3,540	26.5	21.5	9.7	15.8	400	1.5

# AcraDyne HT Pneumatic Tool Accessories

## Polyurethane Hose for HT Tools



ASH-500C-15MSZ

- Durable Polyurethane is chemical resistant and lightweight, and provides excellent recoil memory and maximum flexibility
- Available in transparent hose color (opaque also available)
- Assemblies for coiled hose include reusable swivel fitting. Straight hose available with or without fittings
- Working temperature: -104° F to 175° F
- Working pressure: 100 PSI

### Single Air Hose Assemblies (Coiled)

Model	Description (O.D. x I.D. x Length)	Retracted Length	Npt Fittings
ASH-500C-15MSZ	3/4" x 1/2" x 15'	13"	1/2"
ASH-500C-25MSZ	3/4" x 1/2" x 25'	23"	1/2"



### Straight Air Hose (Sold Per Foot)

MODEL	DESCRIPTION
ASH-500Z	1/2" I.D.

Contact an AIMCO Customer Service Associate about full reel pricing, 1-503-254-6600, or toll free 1-800-852-1368.

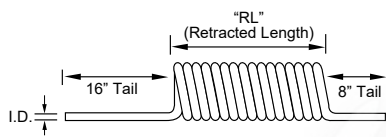

Custom length coil assemblies and special colors available in minimum order quantities. Contact an AIMCO Customer Service Associate, 1-503-254-6600, or toll free 1-800-852-1368.

## Rubber Hose for HT Tools



- Designed for use in a wide range of industrial, construction, and agricultural applications
- Constructed of high grade, reinforced EPDM synthetic rubber
- Working temperature: -40° F to 190° F

### Single Air Hose (Rubber)

I.D.	O.D.	Length	Working Pressure	Weight
1/2"	0.81"	10 ft	200 psi	2.0 lb
5/8"	0.97"	10 ft	200 psi	2.7 lb
3/4"	1.12"	10 ft	200 psi	3.4 lb

Custom lengths available. Contact an AIMCO Customer Service Associate for more details, 1-503-254-6600, or toll free 1-800-852-1368.

## REACTION BARS

Tool includes standard, spline attachment reaction device. See page 45 for part numbers. Custom reaction devices are available; contact an AIMCO Customer Service Associate for more details, 1-503-254-6600, or toll free 1-800-852-1368.



Reaction Bars

## Air Line Fittings



### Plugs

Model	Description
28161	1/2" x 1/4" MPT
28162	1/2" x 3/8" MPT
28163	1/2" x 1/2" MPT
28164	1/2" x 1/2" FPT

### Quick-Change Couplers

Model	Description
27768	1/2" FPT
27769	1/2" MPT



### Protective Coupler

Model	Description
27771	Vinyl



### Swivel Fitting

Model	Capacity
500-SZ	1/2" NPT Swivel Fitting

# Pulse Tools: Overview



## HOW DOES A PULSE TOOL WORK?

The unique design of a pulse tool, combining motor power and hydraulics, leads to an assembly tool that produces smooth, controlled torque in a series of very fast (2 – 4 milliseconds) events and virtually no torque reaction.

- At free-speed, the entire pulse unit, a sealed cylinder containing hydraulic fluid and an output shaft, rotates at the same speed as the tool motor
- As resistance to rotation increases, the rotation of the output shaft slows, while the rotation of the cylinder and the hydraulic fluid continues until they approach a seal point within the cylinder
- This seal point produces an increase in fluid pressure and transmits the energy from the rotational mass of the cylinder and fluid to the output shaft, producing torque on the fastener
- After a series of these cycles (pulses), fluid pressure builds to a point that overcomes the limit of a relief valve, allowing pressure to drop and torque to be controlled



## BENEFITS OF AIMCO PULSE TOOLS:

Pulse tools offer advantages in all of the PERQ® elements – productivity, ergonomics, reliability and quality

By partnering with AIMCO, manufacturers can apply the advantages of pulse tools in many ways to reduce production costs and increase profits.

- Productivity – Combining high operating speeds with one-handed operation, AIMCO pulse tools help manufacturers produce at the highest possible rates
- Ergonomics – Light weight, low vibration and no torque reaction make AIMCO pulse tools the safest assembly tools available for threaded assembly
- Reliability – Advances in design and AIMCO's extensive maintenance and training programs add up to years of low cost service from any AIMCO pulse tool
- Quality – AIMCO pulse tools offer the most repeatable torque and clamp load results of any assembly tool, guaranteeing high product quality for manufacturers

# Omega Pulse Tools: UAT Series

## PATENTED AUTO RELIEF TECHNOLOGY:

UAT features patented Auto Relief Technology providing additional control to the application of torque during the pulsing events.

- Auto Relief eliminates initial spike of torque during a cycle. Highly effective on hard joint applications
- Auto Relief ramps up pressure within the pulse unit resulting in more pulses in less time providing a more efficient and even torque event

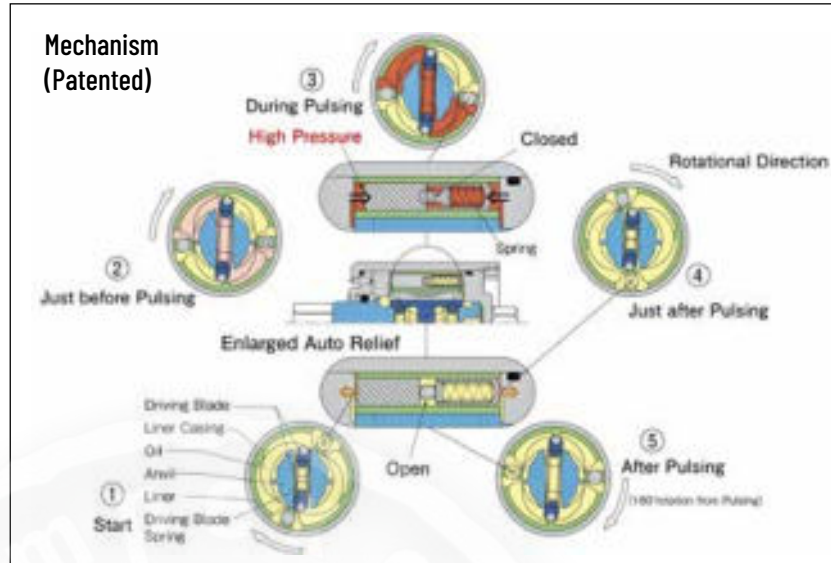

## A NEW LEAP FORWARD IN PRODUCTIVITY AND QUALITY:

- Fastening accuracy and time can be improved by as much as 30% depending on application

### Fastening efficiency comparison (UAT vs ULT)

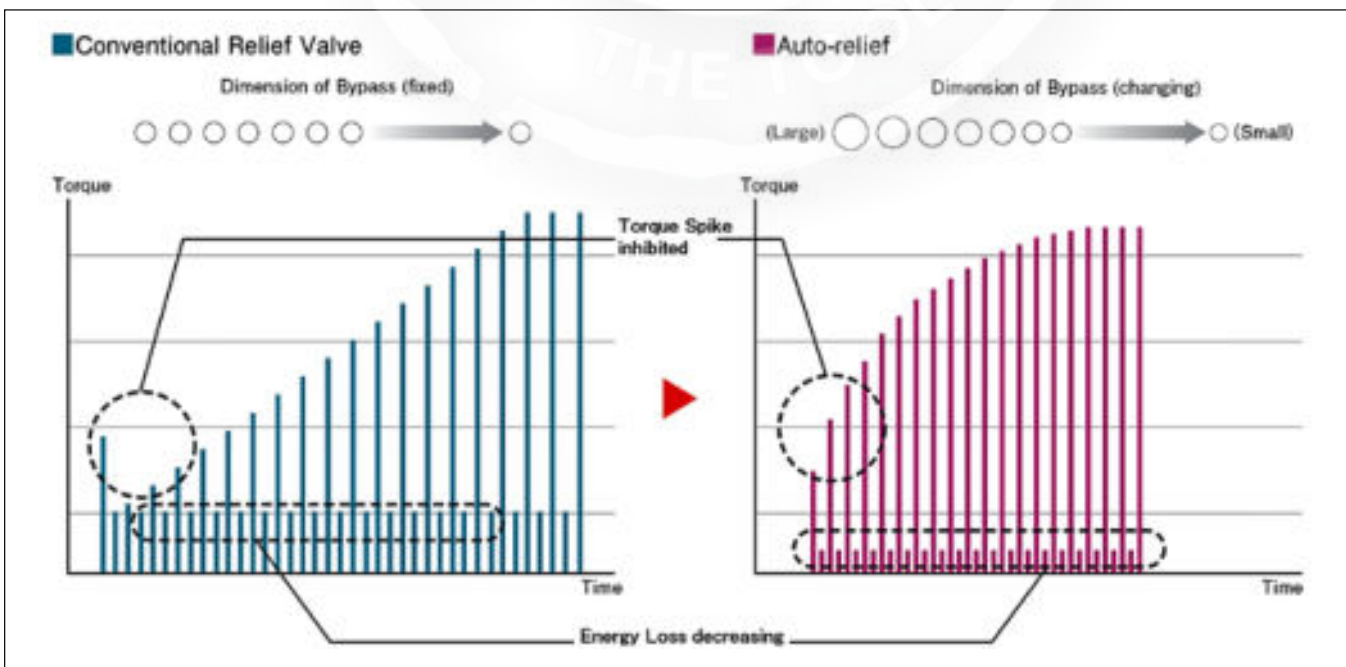
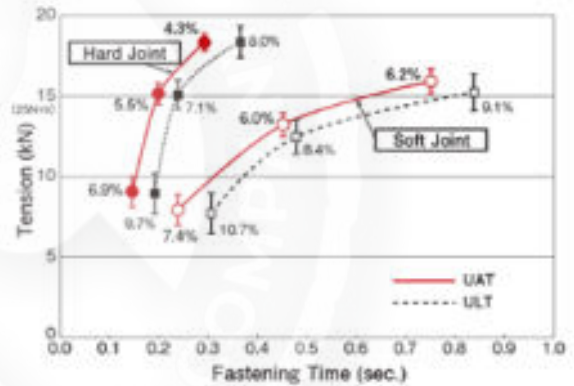



# Omega Pulse Tools: UAT Series



## UAT Series Pistol Shut-Off Tools

Recommended Air Pressure: 85 psi

Model	Free Speed RPM	Torque Range		Weight		Overall Length		Drive	Sound Level	Air Usage
		NM	FT-LB	LB	KG	IN	MM	IN	dB(A)	CFM
UAT-30D	4,200	2.5 - 5.5	1.9 - 4.1	1.9	0.9	6.5	165	1/4	76	10.5
UAT-40	3,800	4.5 - 8	3.3 - 5.9	2.0	0.9	6.4	162	3/8	75	8.8
UAT-40D	3,800	4.5 - 8	3.3 - 5.9	2.0	0.9	6.5	165	1/4	75	8.8
UAT-50	4,600	7 - 15.5	5.2 - 11.5	2.0	0.9	6.4	162	3/8	78	8.8
UAT-50D	4,600	7 - 15.5	5.2 - 11.5	2.0	0.9	6.5	165	1/4	78	8.8
UAT-50L	4,000	7 - 15.5	5.2 - 11.5	2.0	0.9	6.4	162	3/8	75	8.8
UAT-50DL	4,000	7 - 15.5	5.2 - 11.5	2.0	0.9	6.5	165	1/4	75	8.8
UAT-60	6,700	15 - 32	11.1 - 23.7	2.1	1.0	6.8	174	3/8	80	12.3
UAT-60D	6,700	15 - 32	11.1 - 23.7	2.1	1.0	7.0	177	1/4	80	12.3
UAT-60L	6,000	13 - 28	9.6 - 20.7	2.1	1.0	6.8	174	3/8	77	8.8
UAT-70	6,000	30 - 55	22.2 - 40.7	2.3	1.1	7.1	180	3/8	80	14.0
UAT-70L	5,300	25 - 48	18.5 - 35.5	2.3	1.1	7.1	180	3/8	78	10.5
UAT-80	5,600	45 - 63	33.3 - 46.6	2.8	1.3	7.3	186	3/8	80	16.8
UAT-90	5,700	50 - 85	37.0 - 62.9	3.2	1.5	7.6	192	1/2	82	18.6
UAT-90L	5,100	45 - 75	33.3 - 55.5	3.2	1.5	7.6	192	1/2	79	15.8
UAT-100	5,200	70 - 130	51.8 - 96.2	3.7	1.7	7.8	199	1/2	82	19.3
UAT-100L	5,200	60 - 110	44.4 - 81.4	3.7	1.7	7.8	199	1/2	79	16.8
UAT-130	4,500	110 - 150	81.4 - 111	5.1	2.3	8.5	217	1/2	82	24.6
UAT-150	3,900	140 - 210	103.6 - 155.4	6.4	2.9	9.5	240	3/4	82	24.6
UAT-180	3,300	160 - 250	118.4 - 185	8.1	3.7	10.5	264	3/4	84	24.6
UAT-200	2,400	200 - 400	148 - 296	12.8	5.8	11.0	279	3/4	85	35.2
UAT-200L	2,400	170 - 280	125.8 - 207.2	12.8	5.8	11.0	279	3/4	85	24.6



Air Hose Size: 1/4" ID for UAT-30D to UAT-50, 3/8" ID for UAT-60 to UAT-100, 1/2" ID for UAT-100L to UAT-200L Air Inlet Thread: 1/4" NPT for UAT-30D to UAT-150, 3/8" NPT for UAT-180 to UAT-200L

Note Torque Ranges reflect residual B joint torque values

UAT Models containing "L" indicate models designed to run at 57 PSI air pressure.

UAT Models containing "D" indicate 1/4" quick change bit holder

Most models can be equipped with TM (Tightening Monitor) feature for use with qualifier systems. Order TM tools by adding "TM" to model number (for example, UAT-60 becomes UAT-60TM).



## UAT Series Inline Shut-Off Tools

Recommended Air Pressure: 85 psi

Model	Free Speed RPM	Torque Range		Weight		Overall Length		Drive	Sound Level	Air Usage
		NM	FT-LB	LB	KG	IN	MM	IN	dB(A)	CFM
UAT-30SD	3,400	2.5 - 5.5	1.9 - 4.1	1.9	0.8	8.7	222	1/4	68	12.3
UAT-40S	3,300	4.5 - 8.0	3.3 - 5.9	1.9	0.9	8.8	224	3/8	70	7.0
UAT-40SD	3,300	4.5 - 8.0	3.3 - 5.9	1.9	0.9	8.9	227	1/4	70	7.0
UAT-50S	3,900	7.0 - 15.5	5.2 - 11.5	1.9	0.9	8.8	224	3/8	78	8.8
UAT-50SD	3,900	7.0 - 15.5	5.2 - 11.5	1.9	0.9	8.9	227	1/4	78	8.8
UAT-50SL	3,800	7.0 - 15.5	5.2 - 11.5	1.9	0.9	8.8	224	3/8	75	7.0
UAT-50SDL	3,800	7.0 - 15.5	5.2 - 11.5	1.9	0.9	8.9	227	1/4	75	7.0
UAT-60S	5,700	15.0 - 32.0	11.1 - 23.7	1.9	0.9	9.0	229	3/8	80	10.5
UAT-60SD	5,700	15.0 - 32.0	11.1 - 23.7	1.9	0.9	9.1	232	1/4	80	10.5
UAT-60SL	5,300	13.0 - 28.0	9.6 - 20.7	1.9	0.9	9.0	229	3/8	77	8.8
UAT-60SDL	5,300	13.0 - 28.0	9.6 - 20.7	1.9	0.9	9.1	232	1/4	77	8.8
UAT-70S	4,700	30.0 - 50.0	22.2 - 37.0	2.1	1.0	9.4	239	3/8	80	12.3
UAT-70SL	4,400	25.0 - 45.0	18.5 - 33.3	2.1	1.0	9.4	239	3/8	78	9.5

Air Hose Size: 1/4" ID for UAT-30 to UAT-50, 3/8" ID for UAT-60 to UAT-70

Air Inlet Thread: 1/4" NPT

Note Torque Ranges reflect residual B joint torque values

UAT Models containing "D" indicate 1/4" quick change bit holder

UAT Models containing "L" indicate models designed to run at 57 PSI air pressure.

Most models can be equipped with TM (Tightening Monitor) feature for use with qualifier systems. Order TM tools by adding "TM" to model number (for example, UAT-60 becomes UAT-60TM).

\*  logo indicates where ERGO-DRIVE sockets/extensions benefit tool operation.

# Omega Pulse Tools: UL Series

## OMEGA UL SERIES

Whether the goal is improving productivity, ergonomics, reliability, or quality, the UL Series contains the technology to achieve success.

### FEATURES AND BENEFITS

- Models available from 6 - 230 Nm (4.4 - 170 Ft-lb)
- Available in Standard, Tightening Monitor, and Transducerized versions
- High power-to-weight ratio
- Reduced maintenance and extended service life
- Environmentally friendly design
- Accurate and repeatable

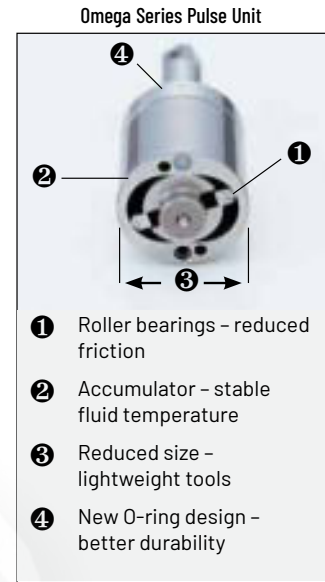

### UL Series Pistol Non Shut-Off Tools

Recommended Air Pressure: 85 psi

Model	Free Speed	Torque Range		Weight		Overall Length		Drive	Sound Level	Air Usage
	RPM	NM	FT-LB	LB	KG	IN	MM			
UL-30D	5,700	6 - 12	4.4 - 8.9	1.5	0.7	5.4	137	1/4 hex	75	7.0
UL-30	5,700	6 - 12	4.4 - 8.9	1.5	0.7	5.2	133	3/8 sq.	75	7.0
UL-40D	6,100	11 - 20	8.1 - 14.8	1.5	0.7	5.4	137	1/4 hex	75	7.0
UL-40	6,100	13 - 22	9.6 - 16.3	1.5	0.7	5.2	133	3/8 sq.	75	7.0
UL-50D	6,400	18 - 28	13.3 - 20.7	1.7	0.8	5.8	146	1/4 hex	78	10.5
UL-50	6,400	22 - 35	16.3 - 25.9	1.7	0.8	5.5	140	3/8 sq.	78	10.5
UL-60D	7,000	22 - 35	16.3 - 25.9	1.8	0.8	5.6	143	1/4 sq.	80	14.0
UL-60	7,000	32 - 50	23.7 - 37.0	1.8	0.8	5.5	140	3/8 sq.	80	14.0
UL-70	5,700	40 - 65	29.6 - 48.1	2.1	1.0	6.0	153	3/8 sq.	80	15.8
UL-80	5,900	45 - 70	33.3 - 50.0	2.5	1.1	6.4	162	3/8 sq.	80	16.8
UL-90	6,000	60 - 100	44.4 - 74.0	2.9	1.3	6.7	170	1/2 sq.	82	18.6
UL-100	5,400	80 - 130	59.2 - 96.2	3.7	1.7	7.0	177	1/2 sq.	80	20.3
UL-130	4,400	100 - 160	74.0 - 118.4	5.1	2.3	7.8	197	1/2 sq.	83	22.7
UL-150	3,800	150 - 230	109.9 - 169.6	6.6	3.0	8.4	213	3/4 sq.	84	24.7



### UL Series Inline Non Shut-Off Tools

Recommended Air Pressure: 85 psi

Model	Free Speed	Torque Range		Weight		Overall Length		Drive	Sound Level	Air Usage
	RPM	NM	FT-LB	LB	KG	IN	MM			
UL-30SD	5,000	6 - 12	4.4 - 8.9	1.4	0.6	8.2	209	1/4 hex	75	8.1
UL-30S	5,000	6 - 12	4.4 - 8.9	1.4	0.6	8.1	205	3/8 sq.	72	8.1
UL-40SD	5,000	9 - 20	6.7 - 14.8	1.4	0.6	8.2	209	1/4 hex	75	8.1
UL-40S	5,000	11 - 22	8.1 - 16.3	1.4	0.6	8.1	205	3/8 sq.	72	8.1
UL-50SD	6,400	18 - 28	13.3 - 20.7	1.6	0.7	8.4	214	1/4 hex	78	12.3
UL-50S	6,400	22 - 35	16.3 - 25.9	1.6	0.7	8.2	208	3/8 sq.	78	12.3
UL-60SD	6,700	22 - 35	16.3 - 25.9	1.7	0.8	8.3	212	1/4 hex	80	15.8
UL-60S	6,700	32 - 50	23.7 - 37.0	1.7	0.8	8.2	209	3/8 sq.	80	15.8
UL-70S	5,400	36 - 60	26.6 - 44.4	1.9	0.9	8.8	223	3/8 sq.	84	14.0

Air Hose Size: 1/4 I.D. for UL-30 (D/SD) - UL-50 (D/SD) - 3/8" I.D. for UL-60 (D/SD) - UL-150 (D/SD)  
All pulse tools ending in "D" include a 1/4" Hex quick-change bit holder.

Air Inlet: N.P.T. 1/4"

NOTE: Torque ranges reflect residual B joint torque values

\*  logo indicates where ERGO-DRIVE sockets/extensions benefit tool operation.

# Omega Pulse: ULT Series



ULT-40C  
ULT-50C



ULT-60C



ULT-70C



ULT-70CH

## ULT Series Angle Shut-Off Tools

Recommended Air Pressure: 85 psi

Model	Free Speed RPM	Torque Range		Weight		Overall Length		Drive	Sound Level	Air Usage
Angle		NM	FT-LB	LB	KG	IN	MM	IN	dB(A)	CFM
ULT-40C	3,500	4.5 - 7.5	3.3 - 5.6	2.9	1.30	9.8	250	3/8" Sq. Dr.	70	7.0
ULT-50C	4,500	7.0 - 15.5	5.2 - 11.5	3.0	1.35	9.8	250	3/8" Sq. Dr.	78	8.6
ULT-60C	5,200	13 - 28	9.6 - 20.7	3.2	1.45	10.3	261	3/8" Sq. Dr.	80	10.5
ULT-70C	4,400	20 - 35	14.8 - 25.9	3.6	1.65	10.8	275	3/8" Sq. Dr.	82	12.3
ULT-70CH	2,500	30 - 50	22.2 - 37.0	4.1	1.85	11.4	290	1/2" Sq. Dr.	82	12.3

"L" following model number denotes Low Air Pressure type  
"H" within model number denotes High Torque type

NOTE: Torque ranges reflect residual B joint torque values



\*  logo indicates where ERGO-DRIVE sockets/extensions benefit tool operation.

# Acra-Pulse Series



U-350D



UXR-2000



UX-ST800

## Acra-Pulse Pistol Tools

Recommended Air Pressure: 85 psi

Model	Free Speed RPM	Torque Range*		Overall Length		Weight		From Center To Outside		Drive SIZE	Noise Level dB(A)	Air Hose I.D.	Air Inlet N.P.T.	Air Usage CFM
		NM	FT-LB	MM	IN	LB	KG	MM	IN					
Non Shut-Off, 1/4" Hex Dr. 1/4" Quick Change Chuck Standard											Air Hose Size: 1/4" I.D. Air Inlet: N.P.T. 1/4"			
U-350D	10,500	3.5 - 5.8	2.5 - 4.2	154	6.1	1.7	0.8	22.0	0.9	1/4" Hex	74	1/4"	1/4"	5.3
Non Shut-Off, 3/4" Sq. Dr. Torque Control in Right-Hand Rotation Standard Left-Hand Rotation also available for UXR-2000											Air Hose Size: 1/2" I.D. Air Inlet: N.P.T. 3/8"			
UXR-2000	4,200	300 - 450	220 - 330	282	11.1	14.3	6.5	47.0	1.8	3/4" Sq. Dr.	85	1/2"	3/8"	31.5
Non Shut-Off, 3/8" Sq. Dr. Auto Reversing Stud Bolt Wrench											Air Hose Size : 3/8" I.D. Air Inlet: N.P.T. 1/4"			
UX-ST800	7,300	35 - 55	25 - 40	195	7.7	3.8	1.8	28.0	1.1	3/8" Sq. Dr.	75	3/8"	1/2"	10.5

\* NOTE: Torque range reflects residual B joint torque values



U-310SD



U-350SD



UX-900S  
UX-1000S



UX-1300S



UXR-T2400S  
UXR-T3000S

## Acra-Pulse Inline Tools

Recommended Air Pressure: 85 psi

Model	Free Speed RPM	Torque Range*		Overall Length		Weight		From Center To Outside		Drive SIZE	Noise Level dB(A)	Air Hose I.D.	Air Inlet NPT	Air Usage CFM
		NM	FT-LB	MM	IN	LB	KG	MM	IN					
Non Shut-Off, 1/4" Hex Dr. 1/4" Quick Change Chuck Standard														
U-310SD	11,000	2.5 - 3.1	1.8 - 2.2	222	8.7	1.5	0.6	18.0	0.7	1/4" Hex	74	1/4"	1/4"	5.3
U-350SD	10,500	3.5 - 5.8	2.5 - 4.2	238	9.4	1.5	0.7	22.0	0.7	1/4" Hex	74	1/4"	1/4"	5.3
Non Shut-Off, 1/2" Sq. Dr.														
UX-900S	7,600	45 - 75	35 - 55	310	12.2	3.9	1.8	37.5	1.1	1/2" Sq. Dr.	75	3/8"	1/4"	14.9
UX-1000S	6,800	50 - 95	40 - 70	320	12.6	4.6	2.1	39.0	1.1	1/2" Sq. Dr.	75	3/8"	1/4"	17.9
UX-1300S	6,200	80 - 130	60 - 95	336	13.2	6.6	2.6	42.0	1.3	1/2" Sq. Dr.	77	3/8"	1/4"	19.4
Shut-Off, 1" Sq. Dr. Inside Trigger Standard														
UXR-T2400S	3,600	360 - 650	260 - 470	444	17.5	26.5	12.0	61.5	2.4	1" Sq. Dr.	85	1/2"	1/2"	35.3
UXR-T3000S	4,400	450 - 850	330 - 620	477	18.8	32.0	14.5	62.0	2.4	1" Sq. Dr.	85	1/2"	1/2"	37.1

\* NOTE: Torque range reflects residual B joint torque values



UX-500C



UX-612C



UX-700C



UX-800C



UX-1000C

## Acra-Pulse Angle Tools

Recommended Air Pressure: 85 psi

Model	Free Speed RPM	Torque Range*		Weight		Overall Length		Drive SIZE	Noise Level dB(A)	Air Hose I.D.	Air Inlet N.P.T.	Air Usage CFM
		NM	FT-LB	LB	KG	MM	IN					
Non Shut-Off, 3/8" Sq. Dr.												
UX-500C	9,300	13 - 20	10.0 - 15.0	2.8	1.3	270	10.6	3/8" Sq. Dr.	82	1/4"	1/4"	8.8
UX-612C	9,800	16 - 28	12.0 - 20.0	3.0	1.4	283	11.1	3/8" Sq. Dr.	85	3/8"	1/4"	11.2
UX-700C	9,500	20 - 36	16.0 - 28.0	3.7	1.7	273	10.8	3/8" Sq. Dr.	85	3/8"	1/4"	12.3
UX-800C	9,000	29 - 43	20.0 - 31.0	4.3	1.9	285	11.2	3/8" Sq. Dr.	85	3/8"	1/4"	14.1
Non Shut-Off, 1/2" Sq. Dr.												
UX-1000C	6,800	50 - 80	40.0 - 58.0	6.8	3.1	365	14.4	1/2" Sq. Dr.	90	3/8"	1/4"	17.9

\*NOTE: Torque ranges reflect residual B joint torque values

\*  logo indicates where ERGO-DRIVE sockets/extensions benefit tool operation.

# UTM Series Fastening Counter

## Flexible Poka-Yoke for Quality and Line Control

The UTM-1500 Fastening Counter helps you verify that your assembly procedures are being followed. Parameter setup is simple and can be programmed at the front panel or via a PC. The UTM-1500 provides audible and visual Accept/Reject indications on all rundowns, ensuring that all your fastening is secure.



### FEATURES AND BENEFITS

- For use with tools that have the TM feature installed, including AIMCO pulse tools, AIMCO angle nutrunners, AIMCO clutch screwdrivers, and all pistol or lever-start screwdrivers
- Automatically set up pressure values
- Communication and line control:
  - PLC communication inputs (5)/outputs (8)
  - Remote parameter switch selection
  - Variable relays for interfacing with process equipment
  - Optional network interfaces available
- Qualification of “good cycle”



### PROCESS VERIFICATION

- Four selectable parameters
- Cycle counting and batch counting
- Programmable timers for detection of double hits, cross-threads, or premature trigger release

### A COMPLETE TURNKEY SYSTEM INCLUDES:

- New or retrofitted TM tool
  - Retrofit most existing AIMCO tools for under \$200. Contact an AIMCO Customer Service Associate, 1-503-254-6600, or toll free 1-800-852-1368.
  - Order TM tools by adding “TM” to model number. (Example: UAT-70 becomes UAT-70TM)
- UTM-1500 Fastening Counter
- Digital Pressure Switch (878-845-1)
- 5 m Sensor Cable (910-831-0) or 10 m Sensor Cable (910-832-0)

### UTM Series Fastener Counters

Model	Voltage & Frequency	Operational Ambient Temperature	Operational Ambient Humidity	Dimensions	Weight	
					LB	KG
UTM-1500	115 V / 50 Hz	0 - 50° C (non-freezing)	90% RH or less (no dew)	200 mm x 210 mm x 100 mm 7.9" x 8.3" x 3.9"	4.5	2.0

# BP-T Pulse Series Cordless Tools

“Operator First” design means a lighter-weight, ergonomic pulse tool

## FEATURES AND BENEFITS

- Direct Power Train and High-Efficiency Brushless Electric Motor deliver reduced noise and vibration
- Hydraulic Impulse Unit delivers reaction-free tightening
- Cooling fan improves heat management, increasing duty cycle up to 20% over the UDBP-TA series
- High-capacity Li-Ion battery pack provides up to 20% more fastener runs per charge than the UDBP-TA series
- The Ergonomic Handle coupled with a Compact Design provides an improved user experience
- Available in regular and wireless transmitting versions (RF8). RF8 models communicate with a receiver for Line Control interfacing



## BP-T Series Tools

Model*	Capacity (Nominal Bolt Size)		Torque Range		Free Speed	Overall Length		Weight W/0 Socket Bit				From Center To Outside		Sq. Dr Or Hex Size		Sound Level dB(A)	Battery Voltage (Capacity)
	MM	IN	NM	FT-LB		MM	IN	KG	LB	KG	LB	MM	IN	MM	IN		
BP-T40-(B)(KIT)	5	No. 10	4.5-8	3.3-5.9	3,300	197	7.8	1.4	3.08	1.15	2.53	27	1.1	9.5 Hex	3/8 Sq.	75	10.8V (2.0Ah)
BP-T40D-(B)(KIT)	5	No. 10	4.5-8	3.3-5.9	3,300	200	7.9	1.4	3.08	1.15	2.53	27	1.1	6.35 Hex	1/4 Hex	75	10.8V (2.0Ah)
BP-T50-(B)(KIT)	6-8	1/4-5/16	7-15	5.1-11.1	3,900	197	7.8	1.4	3.08	1.15	2.53	27	1.1	9.5 Sq.	3/8 Sq.	76	10.8V (2.0Ah)
BP-T50D-(B)(KIT)	6-8	1/4-5/16	6.5-13	4.8-9.6	3,900	200	7.9	1.4	3.08	1.15	2.53	27	1.1	6.35 Hex	1/4 Hex	76	10.8V (2.0Ah)
BP-T60-(B)(KIT)	8	5/16	13-26	9.6-19.2	4,800	202	8.0	1.6	3.52	1.25	2.75	27	1.1	9.5 Sq.	3/8 Sq.	76	14.4V (2.0Ah)
BP-T60D-(B)(KIT)	8	5/16	13-26	9.6-19.2	4,800	205	8.1	1.6	3.52	1.25	2.75	27	1.1	6.35 Hex	1/4 Hex	77	14.4V (2.0Ah)

\* Base models come with no battery. Batteries are available separately or in tool/kit combinations. Add "B" to end of the model number to order 1 tool with 1 battery. Add "KIT" to the end of the model number to order a tool kit, which includes 1 tool, 2 batteries, and 1 battery charger.

\* **E** logo indicates where ERGO-DRIVE sockets/extensions benefit tool operation.

# BP-T Pulse Series Cordless Tools

BP-T series tools with the RF8 option enable wireless communication upon successful shut-off of the tool when fastening. This feature can be used to send the shut-off signal when used with the TW-800R receiver (required). The receiver can be tied to a PLC or the optional UTM-1500 Fastener Counter for collecting fastening counts.

## RF8 : Poka-Yoke Configuration

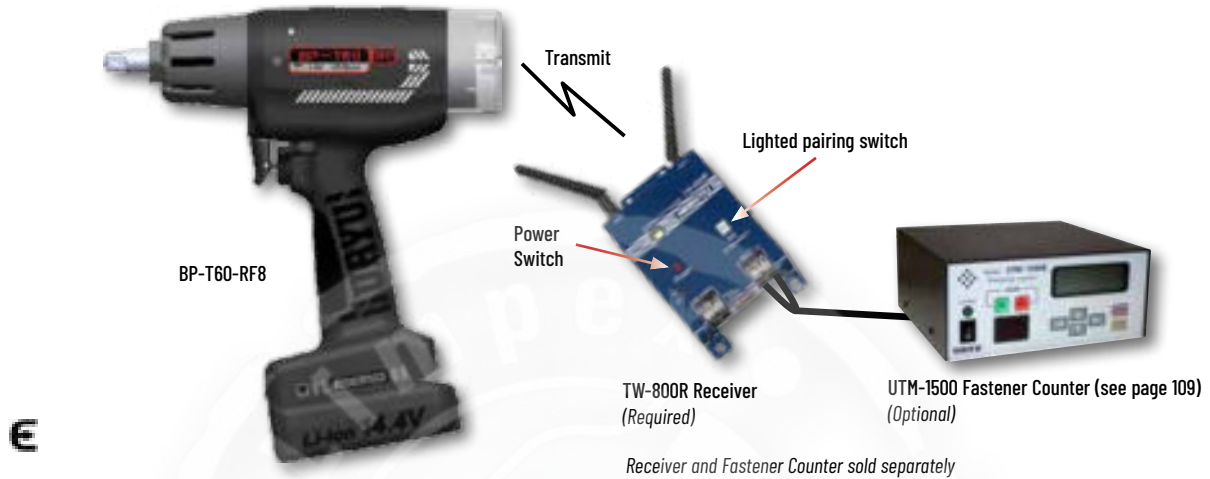

## BP-T RF8 Series Tools

Model*	Capacity (Nominal Bolt Size)		Torque Range		Free Speed	Overall Length		Weight W/O Socket Bit				From Center To Outside		Sq. Dr Or Hex Size		Sound Level dB(A)	Battery Voltage (Capacity)
	MM	IN	NM	FT-LB		MM	IN	W/Battery	W/Out Battery	KG	LB	KG	LB	MM	IN		
BP-T40-RF8-(B)(KIT)	5	No. 10	4.5-8	3.3-5.9	3,300	204	8	1.4	3.08	1.15	2.53	27	1.1	9.5 Hex	3/8 Sq.	75	10.8V (2.0Ah)
BP-T40D-RF8-(B)(KIT)	5	No. 10	4.5-8	3.3-5.9	3,300	207	8.2	1.4	3.08	1.15	2.53	27	1.1	6.35 Hex	1/4 Hex	75	10.8V (2.0Ah)
BP-T50-RF8-(B)(KIT)	6-8	1/4-5/16	7-15	5.1-11.1	3,900	204	8	1.4	3.08	1.15	2.53	27	1.1	9.5 Sq.	3/8 Sq.	76	10.8V (2.0Ah)
BP-T50D-RF8-(B)(KIT)	6-8	1/4-5/16	6.5-13	4.8-9.6	3,900	207	8.2	1.4	3.08	1.15	2.53	27	1.1	6.35 Hex	1/4 Hex	76	10.8V (2.0Ah)
BP-T60-RF8-(B)(KIT)	8	5/16	13-26	9.6-19.2	4,800	209	8.2	1.6	3.52	1.25	2.75	27	1.1	9.5 Sq.	3/8 Sq.	76	14.4V (2.0Ah)
BP-T60D-RF8-(B)(KIT)	8	5/16	13-26	9.6-19.2	4,800	212	8.3	1.6	3.52	1.25	2.75	27	1.1	6.35 Hex	1/4 Hex	77	14.4V (2.0Ah)

\* Base models come with no battery. Batteries are available separately or in tool/kit combinations. Add "KIT" to the end of the model number to order a tool kit, which includes 1 tool, 2 batteries, and 1 battery charger.



10.8 V Battery:  
EYFB32



14.4 V Battery:  
EYFB41



Battery Charger: EYOL82B

## BP-T Series Batteries and Charger

Battery Model #	Description	Voltage	Type	Capacity
EYFB32	Battery for BP-T40 (RF8), BP-T40D (RF8), BP-T50 (RF8), and BP-T50D (RF8) models	10.8V	Li-Ion	2.0Ah
EYFB41	Battery for BP-T60 (RF8) and BP-T60D (RF8)	14.4V	Li-Ion	2.0Ah

Charger Model #	Description	Weight	Input Voltage	Dimensions	Battery Capacity
EYOL82B	Li-Ion battery charger	0.93 kg (2.0 lbs)	120VAC	9.3" D x 7.1" W x 3.6" H	3.0 - 4.2Ah

## BODY JACKET



10C-840-1  
for BP-T40/BP-T50 Series

10E-840-1  
for BP-T60 Series

\* E logo indicates where ERGO-DRIVE sockets/extensions benefit tool operation.

## THE POWER OF **PULSE** WITH THE BENEFITS OF **BATTERY**

UBX-T SERIES ADVANCES QUANTUM LEAP  
FORWARD IN HYDRAULIC PULSE TECHNOLOGY  
MATED TO A POWERFUL BATTERY TOOL

Innovative Elliptical Movement Design with  
larger blades and elimination of springs

**Lengthens Service Intervals** by as much  
as **400%** with a high degree of accuracy and a  
reaction-free operating experience



### Easier, Less Frequent Maintenance

- Pulse unit contains fewer parts making it easier to service
- Patented elliptical movement within the pulse unit produces more power per pulse and balance of work between mechanical components and fluid



### Increased Quality and Performance

- Less required precision in fluid fill without compromise to performance. Easier!
- High pulse frequency and crisp tool shut off results in accurate delivery of torque



### Reduced Cost of Ownership

- Longer fluid life means tool remains in service longer between maintenance
- Routine maintenance requires only "soft parts" and now even fewer of those. Cost reduction!



### Improved Operator Comfort

- Near reaction-free feel and minimal vibration
- Lighter tool weight





# UBX-T Series Cordless Pulse Tools

## UBX-T Shut-Off Battery Oil Pulse Tools

Two new models expand the innovative UBX-T line, which features all of the advantages of the innovative Phoenix pulse unit technology, as well as:

- On-board indicator light confirms fastening results
- Number of fastening per minute:
  - UBX-T60: 8 (fastening time 0.3 seconds at 22 Nm)
  - UBX-T70: 8 (fastening time 0.4 seconds at 40 Nm)
  - UBX-T80: 5 (fastening time 0.4 seconds at 50 Nm)
- Fastener quantity per full charge (on a B joint with 1 sec or less freerun)
  - UBX-T60: 330
  - UBX-T70: 250
  - UBX-T80: 480
- Cycle times on most joints are reduced for more efficient production
- Fluid costs have been reduced by 40% (when using OEM recommended fluid)



## UBX-T RF8 Models - Pokayoke Configuration

UBX-T series tools with the RF8 option enable wireless communication upon successful shut-off of the tool when fastening. This feature can be used to send the shut-off signal when used with the TW-800R receiver (required). The receiver can be tied to a PLC or the optional UTM-1500 Fastener Counter for collecting fastening counts.

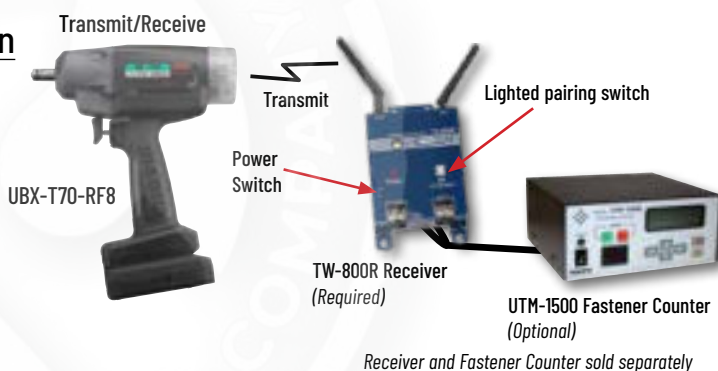

## UBX-T Series Tools

Model	Nominal Bolt Size		Torque		Weight w/o Battery		Free Speed RPM	Length (Minus Socket)		Sq. Drive IN
	MM	IN	NM	FT-LB	KG	LB		MM	IN	
UBX-T60	8 - 10	5/16 - 3/8	18 - 36	13 - 27	1.3	2.9	4,800	179	7.0	3/8 SQ
UBX-T60D	8 - 10	5/16 - 3/8	15 - 30	11 - 22	1.3	2.9	4,800	183	7.2	1/4 QC
UBX-T70	8 - 12	5/16 - 1/2	25 - 55	18 - 41	1.3	2.0	4,800	187	7.4	3/8 SQ
UBX-T70-RF8	8 - 12	5/16 - 1/2	25 - 55	18 - 41	1.4	3.1	4,800	193	7.6	3/8 SQ
UBX-T80	10 - 12	3/8 - 1/2	35 - 65	26 - 48	1.4	3.1	4,800	199	7.8	3/8 SQ

Base model comes with no battery. Batteries are available separately or in tool/kit combinations. Add "B" to end of the model number to order 1 tool with 1 battery. Add "KIT" to the end of the model number to order a tool kit, which includes 1 tool, 2 batteries, and 1 battery charger.

## Batteries and Battery Charger

Battery Model#	Description	Voltage	Type	Capacity
EYFB41	Battery for UBX-T60 & UBX-T70 models	14.4V	Li-Ion	2.0Ah
EYFB43B	Battery for UBX-T60 & UBX-T70 models	14.4V	Li-Ion	4.0Ah
EYFB50	Battery for UBX-T80 models	18V	Li-Ion	5.0Ah

Charger Model #	Description	Weight	Input Voltage	Dimensions	Battery Capacity
EY0L82B	Li-Ion battery charger	0.93 kg (2.0 lbs)	120VAC	9.3" D x 7.1" W x 3.6" H	3.0 - 4.2Ah



# AIMCO Cordless XT Series

## Transducerized Cordless Freedom for Your Bolting Applications



AIMCO's XT Series Cordless Tool is an excellent choice for any application that requires flexibility and uninterrupted operation. These high-efficiency tools feature a brushless motor and provide three selectable tightening strategies: Torque Control, Torque Control with Angle Reporting, and Angle Control with Torque Reporting.

The built-in transducer means precise measurement and traceability. The digital display panel facilitates programming, allows changes in preset values and strategies, and accesses stored information. User interface software is available at no cost to the user and has no licensing requirements.



### FEATURES AND BENEFITS

- Built-in transducer for measurement and traceability
- Torque overload limit function removes responsibility from the operator
- Ultimate flexibility with three selectable tightening strategies:
  - Torque Control
  - Torque Control with Angle Monitor
  - Torque Control plus Angle
- Temperature-monitoring sensor helps prevent overheating
- High-efficiency brushless motor provides longer motor life and increased efficiency
- Monitor and review reliable data with results stored on tool log and easily extractable through USB
- User-friendly digital adjustment and display of wrench status provides quick operator feedback
- Anti-Windup feature facilitates release from application
- Batteries and charging systems readily available from many sources

# AIMCO Cordless XT Series



ABETP Series Tool with Custom AcraDyne Reaction Bar

Many custom reaction devices are available. Contact an AIMCO Customer Service Associate for more details, 1-503-254-6600, or toll free 1-800-852-1368.



Digital Display and Control Interface

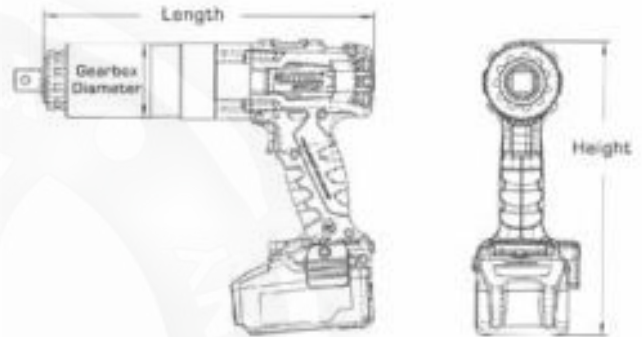

## AcraDyne Cordless XT Series Tools

Model*	Torque Range**		Drive Size IN	RPM	Length		Height		Gearbox Dia.		Weight		Noise Level dB(A)
	NM	FT-LB			MM	IN	MM	IN	MM	IN	KG	LB	
ABETP-350 (-KIT-120V) (-KIT-220V)	100 - 350	74 - 258	3/4"	15	206	8.1	267	10.5	68	2.7	2.9	6.4	80
ABETP-500 (-KIT-120V) (-KIT-220V)	150 - 500	110 - 370	3/4"	10	206	8.1	267	10.5	68	2.7	2.9	6.4	80
ABETP-800 (-KIT-120V) (-KIT-220V)	230 - 800	170 - 590	3/4"	6	253	10	267	10.5	68	2.7	3.3	7.3	80
ABETP-1400 (-KIT-120V) (-KIT-220V)	300 - 1,400	220 - 1,030	3/4"	6	253	10	267	10.5	68	2.7	3.3	7.3	80
ABETP-1700 (-KIT-120V) (-KIT-220V)	550 - 1,700	405 - 1,250	1"	4	328	12.9	267	10.5	78	3.1	5.3	11.7	80
ABETP-2800 (-KIT-120V) (-KIT-220V)	700 - 2,800	515 - 2,065	1"	3.5	316	12.4	267	10.5	78	3.1	5.8	12.8	80
ABETP-3100 (-KIT-120V) (-KIT-220V)	900 - 3,100	664 - 2,285	1"	2.5	316	12.4	267	10.5	78	3.1	5.8	12.8	80
ABETP-3500 (-KIT-120V) (-KIT-225V)	350 - 3,500	258 - 2,582	1"	2	312	12.3	267	10.5	82	3.2	6.1	13.4	80
ABETP-4000 (-KIT-120V) (-KIT-220V)	810 - 4,000	595 - 2,950	1"	2	312	12.3	267	10.5	82	3.2	6.1	13.4	80
ABETP-4500 (-KIT-120V) (-KIT-220V)	1200 - 4,450	885 - 3,282	1"	2	370	14.6	267	10.5	86	3.4	8.1	17.9	80

\* Base model comes with no battery. Base model includes tool and standard reaction bar. Batteries are available separately or in tool/kits combinations.

\*\*Tools should be sized to be used at no more than 80% of their maximum torque capability.

Add "-KIT" to the end of the model number to order a tool kit, which includes 1 tool, 2 batteries, and 1 battery charger. The part number must also specify "120V" or "220V" depending on power requirements.



18V Li-Ion Battery  
625368000

Battery Charger  
120V: 627046000  
220V: 627044000

## Li-Ion HD BATTERY AND CHARGER

- 5.5 Ah 18V Li-Ion battery
- LiHD battery provides ultimate performance and extremely long use with minimal temperature variation
- Air cooled charging technology: Battery pack cools during charging, significantly reducing charging times
- Processor-controlled charge and discharge management
- Battery can be stored with almost no self-discharge

# UAN Series Angle Nutrunners

## UAN SERIES ANGLE NUTRUNNERS

Designed for fastening in tight quarters or applications not served well by a pulse tool. The UAN Series transfers torque through beveled angle gears, continuously driving the fastener. When the resistance to rotation overcomes the spring resistance on the clutch, the tool will disengage at the adjusted torque value. Low reaction force characteristics on hard joints make it comfortable for the operator to use. Ideal for applications ranging from 6 - 60 Nm (4 - 44 ft-lb).

- Torque Control
- Electronically Monitored or Controlled type



## UAN Series Angle / Inline Tools

Recommended Air Pressure: 85 psi

Model	Torque Range		Free Speed RPM	Overall Length		Angle Head Height		From Center To Outside		Weight Less Socket		Square Drive IN	Noise Level dB(A)	Air Usage CFM
	NM	FT-LB		MM	IN	MM	IN	MM	IN	KG	LB			
Angle														
UAN-611R-60C	6.5 - 12.0	4.3 - 8.6	620	383	15.1	47	1.9	14.0	0.5	1.6	3.5	3/8	80	21.2
UAN-611R-50C	8.5 - 15.0	5.7 - 10.8	470	373	14.7	47	1.9	14.0	0.5	1.6	3.5	3/8	80	21.2
UAN-611R-40C	10.0 - 18.0	7.2 - 12.9	400	373	14.7	47	1.9	14.0	0.5	1.6	3.5	3/8	80	21.2
UAN-611R-30C	13.0 - 25.0	9.3 - 18.0	270	373	14.7	47	1.9	14.0	0.5	1.6	3.5	3/8	80	21.2
UAN-701R-60C	20.0 - 31.0	14.5 - 23.1	600	445	17.5	47	1.9	14.0	0.5	2.4	5.3	3/8	85	31.8
UAN-701R-40C	28.0 - 45.0	21.0 - 33.3	400	455	17.9	51	2.0	18.0	0.7	2.4	5.3	3/8	85	31.8
UAN-701R-30C	37.0 - 60.0	27.5 - 44.1	300	455	17.9	58	2.3	18.0	0.7	2.4	5.3	1/2	85	31.8

Air Hose Size: 3/8 I.D.

Air Inlet: N.P.T. 1/4



Application-specific, custom-made tools and accessories are available for your application. Contact an AIMCO Customer Service Associate for more details, 1-503-254-6600, or toll free 1-800-852-1368.

**E** logo indicates where ERGO-DRIVE sockets/extensions benefit tool operation.

# URW Series Nutrunners

## URW SERIES IN-LINE RATCHET WRENCHES

Designed to set flush over the fastener head, the URW Series is ideal for narrow fastening spaces. Motor torque is transferred from a gear driven, dual lobed cam that pushes a spring loaded push rod, rotating the socket one tooth at a time. A wide variety of socket sizes, head thicknesses, and tool lengths allow the URW Series access to many difficult applications.

- Check table for standard output drive gears available. Special orders available on request.



## URW Series Ratchet Wrenches

Recommended Air Pressure: 85 psi

Model	Max Torque		Free Speed RPM	Overall Length		Weight		Hex Size of Ratchet (see additional table for part numbers)		Air Usage CFM
	NM	FT-LB		MM	IN	LB	KG	MM	IN	
<b>Straight Head</b>										
URW-6	11	8.1	210	292	11.5	2.5	1.2	6, 7, 8, 10*, 11, 12	1/4, 5/16, 3/8, 7/16	9.9
URW-8N	16	11.8	260	300	11.8	4.2	1.9	7, 8, 9, 10, 11, 12, 13, 14*, 15	1/2	19.5
URW-8	16	11.8	240	360	14.2	5.0	2.3	7, 8, 9, 10, 11, 12, 13, 14*, 15	1/2	19.8
URW-9N	31	22.9	140	380	15.0	5.2	2.4	7, 8, 9, 10, 11, 12, 13, 14*, 15	1/2	23.7
URW-10N	57	42.2	155	394	15.5	5.8	2.7	10, 12, 13, 14, 15, 17*, 19	9/16, 5/8, 11/16, 3/4	25.0
URW-12N	59	43.7	145	397	15.6	5.9	2.7	12, 14, 16, 17, 18, 19, 21*, 22	1/2, 9/16, 5/8, 11/16, 3/4, 13/16	25.0
URW-12NA	78	57.7	105	408	16.1	6.2	2.8	17, 19, 21, 22, 24*, 27	11/16, 3/4, 15/16	25.0

Air Hose Size: 3/8 I.D. Air Inlet: N.P.T. 1/4

\* Hex size included with wrench if no other size is specified. Separate table on this page shows other available ratchet sizes. Custom ratchets are also available and are considered a special order. Additional costs and lead times apply. Contact an AIMCO Customer Service Associate for more information, 1-800-852-1368.

URW Standard Output Drive Gears**	
Model #	Ratchet Size
URW-6	
858-626-1	6 mm
858-792-1	7 mm
858-794-1	8 mm
200-656-5	10 mm
881-164-1	11 mm
858-741-1	12 mm
881-160-1	1/4"
881-161-1	5/16"
881-162-1	3/8"
881-163-1	7/16"

URW-8 / URW-8N / URW-9N	
221-656-1	7 mm
222-656-1	8 mm
201-656-1	9 mm
210-656-1	10 mm
858-655-1	11 mm
211-656-1	12 mm
207-656-1	13 mm
212-656-1	14 mm
881-016-1	15 mm
209-656-1	1/2"

URW-10N	
226-656-1	10 mm
203-656-1	12 mm
209-656-1	13 mm
213-656-1	14 mm
881-090-1	15 mm
214-656-1	17 mm
858-753-1	19 mm
858-835-1	9/16"
858-836-1	5/8"
858-837-1	11/16"
858-838-1	3/4"

URW-12N	
227-656-1	12 mm
225-656-1	14 mm
881-150-1	16 mm
223-656-1	17 mm
881-091-1	18 mm
204-656-1	19 mm
215-656-1	21 mm
858-818-1	22 mm
858-839-1	1/2"
858-830-1	9/16"
858-831-1	5/8"
858-832-1	11/16"
858-833-1	3/4"
858-834-1	13/16"

URW-12NA	
858-922-1	17 mm
858-938-1	19 mm
858-869-1	21 mm
205-656-1	22 mm
216-656-1	24 mm
217-656-1	27 mm
881-167-1	11/16"
881-087-1	3/4"
881-168-1	15/16"

\*\* Additional drive gear sizes are available. A tool ordered with a drive gear outside of the standards listed above is considered a special order. Additional costs and lead times apply. Contact an AIMCO Customer Service Associate for more information, 1-800-852-1368.

# Tube Nut & Geared Wrenches

## UOW SERIES OPEN-END NUTRUNNERS

Designed for tubenut fastening, the UOW Series can transfer torque through a variety of options.

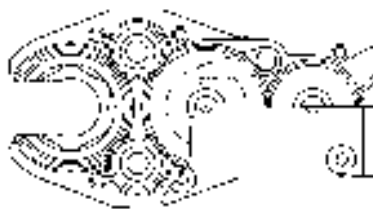

- Stall Type – Depending on the application requirements, the standard UOW Series will stall when torque resistance matches power output
- Mechanical Shut-off Type – For greater torque accuracy and less reaction impulse to the operator, the UOW-T Series incorporates a mechanical clutch to shut off the tool at the preset torque
- Electronically Monitored Type – For critical torque applications requiring monitoring or controlling of the fastening torque, the UOW-M Series utilizes a transducer to signal the clutch shut-off
- UOW series incorporates a one-hand, two-step throttle, which automatically reverses the socket to a preset open position
- Check table for standard output drive gears available. Special orders available on request



## UOW / UOW-T Series Tubenut Wrenches

Recommended Air Pressure: 85 psi

Model	Max Torque/Range		Free Speed RPM	Overall Length		Weight		Hex Size of Gear Socket (see additional table for part numbers)		Noise Level dB(A)	Air Usage CFM
	NM	FT-LB		MM	IN	LB	KG	MM	IN		
<b>Stall</b>											
UOW-T1-10	13	9.6	390	295	11.7	3.3	1.5	8, 9, 10*, 11, 12	1/4, 5/16, 3/8, 7/16	76	10.5
UOW-T1-14	16	11.8	290	311	12.3	3.5	1.6	10, 11, 12, 13, 14*, 15, 17	7/16, 9/16	76	10.5
UOW-T1-22	24	17.8	220	326	12.8	3.9	1.8	12, 13, 14, 17, 18, 19, 21, 22*, 24	—	76	10.5
UOW-T1-30	32	23.7	160	347	13.7	4.4	2.0	17, 18, 19, 23, 24, 26, 27, 29, 30*, 32	5/8, 11/16, 3/4, 7/8, 15/16, 1-1/8, 1-3/16	76	10.5
<b>Shut-Off Clutch</b>											
UOW-T60-10	4 - 14	3.0 - 10.4	300	370	14.6	4.6	2.1	8, 9, 10*, 11, 12	1/4, 5/16, 3/8, 7/16	76	10.5
UOW-T60-14	5 - 17	3.7 - 12.6	240	385	15.1	4.9	2.2	10, 11, 12, 13, 14*, 15, 17	7/16, 9/16	76	10.5
UOW-T60-22	7 - 24	5.2 - 17.8	170	400	15.8	5.2	2.4	12, 13, 14, 17, 18, 19, 21, 22*, 24	—	76	10.5
UOW-T60-30	10 - 32	7.4 - 23.7	130	420	16.6	5.7	2.6	17, 18, 19, 23, 24, 26, 27, 29, 30*, 32	5/8, 11/16, 3/4, 7/8, 15/16, 1-1/8, 1-3/16	76	10.5
<b>Geared Wrenches</b>											
UGW-6N	18	13.3	530	310	12.2	3.1	1.4	9, 10*, 11, 12	—	76	10.5
UGW-8N	23	17.0	410	322	12.7	3.2	1.5	12, 13, 14*, 17	—	76	10.5

Air Hose Size: 3/8 I.D.

Air Inlet: N.P.T. 1/4

\* Hex size included with wrench if no other size is specified. Separate table on this page shows other available socket sizes. Custom sockets are also available and are considered a special order. Additional costs and lead times apply. Contact an AIMCO Customer Service Associate for more information, 1-800-852-1368.

## UOW/UGW Standard Output Drive Gears\*\*

Model #	Socket Size
<b>UOW-T1-10 / UOW-T60-10</b>	
858-966-1	8 mm
858-967-1	9 mm
233-447-0	10 mm
858-968-1	11 mm
862-531-1	12 mm
862-503-1	1/4"
862-546-1	5/16"
862-500-1	3/8"
862-714-1	7/16"

<b>UOW-T1-14 / UOW-T60-14</b>	
858-960-1	10 mm
858-974-1	11 mm
858-971-1	12 mm
858-972-1	13 mm
233-447-4	14 mm
862-579-1	15 mm
862-514-1	17 mm
862-501-1	7/16"
858-973-1	9/16"

<b>UOW-T1-22 / UOW-T60-22</b>	
862-747-1	12 mm
862-728-1	13 mm
858-976-1	14 mm
858-992-1	17 mm
858-977-1	18 mm
858-994-1	19 mm
858-941-1	21 mm
234-447-0	22 mm
862-530-1	24 mm

<b>UOW-T1-30 / UOW-T60-30</b>	
862-590-1	17 mm
862-760-1	18 mm
862-535-1	19 mm
858-981-1	23 mm
858-999-1	24 mm
862-532-1	26 mm
858-982-1	27 mm
858-983-1	29 mm
234-447-6	30 mm
862-558-1	32 mm
862-516-1	5/8"
862-756-1	11/16"
862-545-1	3/4"
862-511-1	7/8"
862-542-1	15/16"
862-513-1	1-1/8"
862-533-1	1-3/16"

<b>UGW-6N</b>	
863-000-1	9 mm
246-447-0	10 mm
863-001-1	11 mm
863-004-1	12 mm

<b>UGW-8N</b>	
863-002-1	12 mm
863-003-1	13 mm
246-447-5	14 mm
863-026-1	17 mm

\*\* Additional drive gear sizes are available. A tool ordered with a drive gear outside of the standards listed above is considered a special order. Additional costs and lead times apply. Contact an AIMCO Customer Service Associate for more information, 1-800-852-1368.

# DynaTorque Manual Torque Multipliers

## DynaTorque



ATM-800



ATM-1800



ATM-3800



ATM-16000

### FEATURES AND BENEFITS

Manual Torque Multipliers offer the perfect, economical solution to high torque bolting applications.

- Superior power to weight ratio
- Delivered torque accuracy +/- 4%
- Anti-Wind Up safety feature (2,800 NM models and up) prevents input device from springing backward when released
- True torque multiplication ratios
- Standard reaction arms supplied. Custom reaction arms/nose extensions available to suit specific applications
- No preventative maintenance required
- Overload protected by shear-drive design (spare torsion shaft included). Easily replace sheared-off pins at the work site

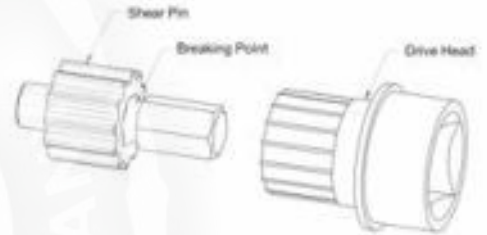

### DynaTorque Manual Torque Multipliers

Model	Input IN	Output IN	Ratio	Max Torque Output		A (MM)	B (MM)	C (MM)	D (MM)	Weight*	
				Nm	Ft-Lb					LB	KG
ATM-800	1/2	3/4	1:3.5	800	590	65	105	132	130	2.9	1.3
ATM-1800	3/4	1	1:3.6	1,800	1,327	90	150	188	132	6.6	3.0
ATM-2800	1/2	1	1:13	2,800	2,066	95	200	240	132	11.5	5.2
ATM-3800	3/4	1	1:13	3,800	2,804	95	200	240	132	11.5	5.2
ATM-5000	3/4	1.5	1:17	5,000	3,690	120	215	272	150	15.4	7.0
ATM-8000	3/4	1.5	1:49	8,000	5,904	132	268	344	200	25.4	11.5
ATM-12000	3/4	1.5	1:58	12,000	8,856	156	272	348	200	30.9	14.0
ATM-16000	3/4	2.5	1:75	16,000	11,808	215	292	370	225	57.3	26.0

\* Weight shown does not include weight of reaction device.

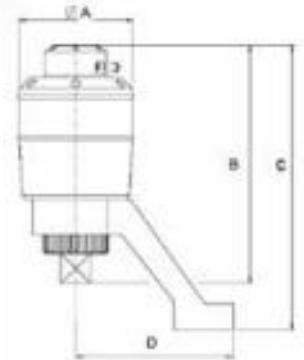

### CARRYING CASE

All DynaTorque Multipliers are supplied in a rugged, weather-resistant, portable carrying case.



# US-LT Pneumatic Screwdrivers

## TORQUE CONTROL AUTOMATIC SHUT-OFF TYPE

- Precise repeatability improves quality
- Minimal wear on internal parts for longer life
- Quick shut off for minimum torque reaction
- Speed choice for flexibility
- Easy external torque adjustment
- Midrange air motor provides high speed during entire cycle
- Ideal for industrial torque control applications



US-LT30B Series



US-LT50B Series



US-LT10B



US-LT20B Series



US-LT40B Series

## US-LT Light Touch Series Inline Push-To-Start Screwdrivers

Recommended Air Pressure: 85 psi

Model	Torque Range		Free Speed RPM	Overall Length		Weight		From Center To Outside		Noise Level dB(A)	Air Usage CFM
	NM	IN-LB		MM	IN	LB	KG	MM	IN		
US-LT10B	0.2 - 0.6	1.8 - 5.3	1,000	191	7.5	0.6	0.3	12.0	0.5	75	5.2
US-LT20B-10	0.4 - 1.1	3.1 - 9.7	1,000	180	7.1	0.7	0.3	13.0	0.5	70	5.6
US-LT20B-18	0.3 - 0.7	2.2 - 6.2	1,800	180	7.1	0.7	0.3	13.0	0.5	70	5.6
US-LT30B-11	1.1 - 2.1	9.7 - 18.5	1,100	187	7.4	0.9	0.4	15.5	0.6	70	7.0
US-LT30B-17	0.7 - 1.5	6.2 - 13.2	1,700	187	7.4	0.9	0.4	15.5	0.6	70	7.0
US-LT30B-23	0.4 - 1.0	3.5 - 8.8	2,300	187	7.4	0.9	0.4	15.5	0.6	71	7.0
US-LT40B-08	1.6 - 4.0	14.1 - 35.2	800	209	8.2	1.4	0.7	16.5	0.6	70	10.5
US-LT40B-15	1.0 - 2.2	6.2 - 19.4	1,500	209	8.2	1.4	0.7	16.5	0.6	70	10.5
US-LT40B-21	1.0 - 1.7	6.2 - 15.0	2,100	209	8.2	1.4	0.7	16.5	0.6	74	10.5
US-LT50B-05	5.0 - 10.2	44.0 - 92.4	480	240	9.5	2.2	1.0	19.5	0.8	74	17.5
US-LT50B-08	3.0 - 5.5	26.4 - 48.4	800	240	9.5	2.2	1.0	19.5	0.8	75	17.5
US-LT50B-17	1.5 - 2.6	9.7 - 23.0	1,700	240	9.5	2.2	1.0	19.5	0.8	75	17.5

Air Hose Size: 1/4 I.D. for US-LT10B - US-LT40B Series - 3/8" I.D. for US-LT50B Series  
Each model is equipped with its standard and alternate clutch springs

Air Inlet: 1/8 for US-LT10B - US-LT20B Series - 1/4" for US-LT30B - US-LT50B Series

### External Torque Adjustment (Air Shut-Off)

Set the hand driver into the key hole on the Adjusting Gear, turn clockwise to increase torque. Turn counter clockwise to decrease torque.

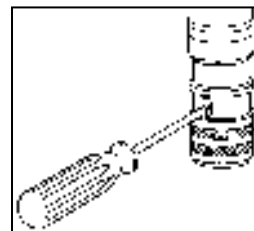



# US-LT Pneumatic Screwdrivers



US-LT30B\_C Series



US-LT40B\_C Series



US-LT40\_C Series



US-LT30BL Series



US-LT40BL Series

## US-LT Light Touch Series Angle and Lever Push-To-Start Screwdrivers

Recommended Air Pressure: 85 psi

Model	Torque Range Soft Joint		Free Speed RPM	Overall Length		Weight		From Center to Outside		Hex Bit Or Drive Size IN	Noise Level dB(A)	Air Usage CFM
	NM	IN-LB		MM	IN	LB	KG	MM	IN			
<b>Angle</b>												
US-LT30B-11C	1.1 - 2.1	3.5 - 18.5	1,100	298	10.7	1.5	0.7	36	1.4	1/4	73	7.0
US-LT30B-17C	0.7 - 1.5	3.5 - 13.2	1,700	295	10.7	1.5	0.7	36	1.4	1/4	73	7.0
US-LT40B-03C	5.0 - 10.0	44 - 88	300	359	14.2	2.4	1.1	35.5	1.4	3/4	72	10.5
US-LT40B-05C	2.3 - 5.7	20.0 - 49.5	500	322	13.0	2.1	0.9	38.5	1.5	1/4	75	10.5
US-LT40B-08C	1.6 - 4.0	8.7 - 34.7	800	320	12.8	2.0	0.9	36	1.4	1/4	75	10.5
US-LT40B-15C	1.0 - 2.2	8.7 - 19.4	1,500	320	12.8	2.0	0.9	36	1.4	1/4	75	10.5
US-LT40-03C	5.0 - 10.0	43.4 - 86.8	300	360	14.2	2.4	1.1	35.5	1.4	1/4 Sq.	72	10.5
US-LT40-05C	2.3 - 5.7	20.0 - 50.2	500	322	13.0	2.1	0.9	35.5	1.4	1/4 Sq.	75	10.5
US-LT40-08C	1.6 - 4.0	8.7 - 34.7	800	320	12.8	2.0	0.9	32	1.3	1/4 Sq.	75	10.5
<b>Lever</b>												
US-LT30BL-11	1.1 - 2.1	9.7 - 18.5	1,100	229	8.2	1.2	0.5	15	0.6	1/4	70	5.2
US-LT30BL-17	0.7 - 1.5	6.2 - 13.2	1,700	229	8.2	1.2	0.5	15	0.6	1/4	70	5.2
US-LT40BL-08	1.6 - 4.0	14.1 - 35.2	800	249	9.8	1.5	0.7	17	0.7	1/4	70	5.6
US-LT40BL-15	1.0 - 2.2	8.8 - 19.4	1,500	249	9.8	1.5	0.7	17	0.7	1/4	70	5.6

Angle Head Height: 32 - 36 mm

Air Inlet: N.P.T. 1/4"

Air Hose Size: 1/4" I.D. for all models



US-LT31PB Series



US-LT41PB Series



US-LT51PB Series



US-LT60P Series

## US-LT Light Touch Series Pistol Push-To-Start Screwdrivers

Recommended Air Pressure: 85 psi

Model	Torque Range (Soft Joint)		Free Speed RPM	Overall Length		Weight		From Center to Outside		Noise Level dB(A)	Air Usage CFM
	NM	IN-LB		MM	IN	LB	KG	MM	IN		
US-LT31PB-05	2.4 - 5.0	21.1 - 44.0	500	189	8.2	1.9	0.9	16	0.6	70	7.0
US-LT31PB-11	1.1 - 2.1	9.7 - 18.5	1,100	170	7.0	1.6	0.7	16	0.6	70	7.0
US-LT31PB-17	0.7 - 1.5	6.2 - 13.2	1,700	170	7.0	1.6	0.7	16	0.6	70	7.0
US-LT31PB-23	0.4 - 1.0	3.5 - 8.8	2,300	170	7.0	1.6	0.7	16	0.6	70	7.0
US-LT41PB-08	1.6 - 4.0	14.0 - 35.2	800	175	7.7	1.9	0.9	17	0.6	70	10.5
US-LT41PB-15	1.0 - 2.2	8.8 - 19.4	1,500	175	7.7	1.9	0.9	17	0.6	70	10.5
US-LT41PB-21	1.0 - 1.7	8.8 - 15.0	2,500	175	7.7	1.9	0.9	17	0.6	74	10.5
US-LT51PB-05	5.0 - 10.5	44.0 - 92.4	480	198	8.5	2.6	1.2	20	0.8	74	17.5
US-LT51PB-08	3.0 - 5.5	26.4 - 48.4	800	198	8.5	2.6	1.2	20	0.8	75	17.5
US-LT51PB-17	1.5 - 2.6	13.2 - 22.9	1,700	198	8.5	2.6	1.2	20	0.8	75	17.5
US-LT60P-03*	7.0 - 20.0	61.6 - 176.0	320	230	9.1	3.7	1.7	22	0.9	75	21.0
US-LT60P-07*	4.0 - 10.0	35.2 - 88.0	650	230	9.1	3.7	1.7	22	0.9	76	21.0
US-LT60P-11*	4.0 - 7.0	35.2 - 61.6	1,100	230	9.1	3.7	1.7	22	0.9	77	21.0

Air Hose Size: 1/4 I.D. for US-LT31PB & US-LT41PB Series

Air Inlet: N.P.T. 1/4"

3/8 I.D. for US-LT31PB-05, US-LT51PB Series & US-LT60P Series

\* Optional 3/8" Sq. Drive available for US-LT60P Series ADD (P) to Model Number

# US-LT Pneumatic Screwdriver Accessories



## US-LT Screwdriver Optional Clutch Springs

Model	Clutch Springs Provided		Recommended Torque Range		Clutch Spring Code Number
	Standard	Option	Hard Joint		
			Nm	in-lb	
US-LT10B	Black		0.20 - 0.60	1.7 - 5.2	976-379-0
US-LT20B-10	Black		0.34 - 1.10	3.0 - 9.5	976-432-0
		Red	0.20 - 0.70	1.7 - 6.1	976-431-0
		Yellow	0.15 - 0.34	1.3 - 3.0	976-430-0
US-LT20B-18	Red		0.24 - 0.67	2.2 - 6.1	976-431-0
		Yellow	0.15 - 0.34	1.3 - 3.0	976-430-0
US-LT31PB-05	Red	Pink	2.35 - 5.00	20.9 - 44.0	976-493-0
US-LT30 Series, 1,100 rpm	Blue		0.98 - 2.1	8.7 - 18.5	976-472-0
		Red	0.67 - 1.76	6.1 - 15.6	976-493-0
		Pink	0.39 - 0.98	3.5 - 8.7	976-471-0
US-LT30 Series, 1,700 rpm	Black	(not included)	1.22 - 2.74	10.8 - 24.3	976-504-0
		Red	0.67 - 1.47	6.1 - 13.0	976-493-0
US-LT30 Series, 2,300 rpm	Red	Pink	0.39 - 0.98	3.5 - 8.7	976-471-0
			0.39 - 0.98	3.5 - 8.7	976-471-0
US-LT40-03C	Red		4.90 - 9.80	43.4 - 86.8	976-516-0
US-LT40 Series, 800 rpm	Black		1.57 - 3.92	13.9 - 34.7	976-515-0
		Red	0.98 - 2.17	8.7 - 19.1	976-516-0
		Yellow	0.98 - 1.67	8.7 - 14.8	976-517-0
US-LT40 Series, 1,500 rpm	Red		0.98 - 2.17	8.7 - 19.1	976-516-0
		Yellow	0.98 - 1.67	8.7 - 14.8	976-517-0
US-LT40 Series, 2,100 rpm	Yellow		0.98 - 1.67	8.7 - 14.8	976-517-0
US-LT50 Series, 500 rpm	Black		4.9 - 10.3	43.4 - 91.1	976-620-0
		Red	2.9 - 5.4	26.1 - 47.7	976-614-0
		Yellow	1.4 - 2.5	13.0 - 22.6	976-588-0
US-LT50 Series, 800 rpm	Red		2.7 - 5.4	24.3 - 47.7	976-614-0
		Yellow	1.4 - 2.5	13.0 - 22.6	976-588-0
US-LT50 Series, 1,700 rpm	Yellow		1.4 - 2.6	13.0 - 23.0	976-588-0

# US & US-LD Pneumatic Screwdrivers



US-LD40P-15



US-LD50P-08



US-3.5ACB

## US-LD Direct Drive Series Screwdrivers

Recommended Air Pressure: 72 psi

Model	Max Torque		Free Speed		Overall Length		Weight		From Center to Outside		Noise Level dB(A)	Air Usage CFM	
	Soft Joint NM	Hard Joint FT-LB	RPM	RPM	MM	IN	LB	KG	MM	IN			
Pistol													
US-LD40P-08	4.8	3.6	5.7	4.2	940	130	5.1	1.5	0.7	17	0.7	70	14.0
US-LD40P-15	3.0	2.2	3.2	2.4	1,700	130	5.1	1.5	0.7	17	0.7	70	14.0
US-LD40P-21	2.0	1.5	2.8	2.1	2,500	130	5.1	1.5	0.7	17	0.7	74	14.0
US-LD50P-05	10.0	7.4	11.2	8.3	500	153	6.0	2.0	0.9	20	0.8	74	17.5
US-LD50P-08	6.5	4.8	7.8	5.8	900	153	6.0	2.0	0.9	20	0.8	75	17.5
US-LD50P-17	3.5	2.6	5.9	4.4	1,900	150	5.9	2.0	0.9	20	0.8	75	17.5

Angle	Max Torque		Capacity (Screw Size)		Free Speed RPM	Overall Length		Weight		From Center To Outside		Noise Level dB(A)	Air Usage CFM		
	Soft Joint NM	Hard Joint FT-LB	MM	IN		MM	IN	LB	KG	MM	IN				
US-3.5ACB	1.75	1.1	2.5	1.8	2,000	4	No. 8	200	7.9	1.4	0.7	10.0	0.4	85	7.0

Air Hose Size: 1/4" I.D. Air Inlet: N.P.T. 1/4"



US-3.5B



US-5

## US Cushion Clutch Series Screwdrivers

Recommended Air Pressure: 57 psi

Model	Capacity (Screw Size)		Free Speed RPM	Overall Length		Weight Less Bit		From Center to Outside		Noise Level dB(A)	Air Usage CFM
	MM	IN		MM	IN	LB	KG	MM	IN		
US-3.5B	4	No. 8	2,000	214	8.5	1.4	0.6	17	0.7	75	7.0
US-5	5	No. 10	1,400	236	7.1	2.4	1.1	21	0.8	75	7.0

Air Hose Size: 1/4" I.D. Air Inlet: N.P.T. 1/4"



US-350PW



US-450PW



US-652PW



US-450WB

## US Impact Series Screwdrivers

Model	Capacity (Screw Size)		Free Speed RPM	Overall Length		Weight Less Bit		From Center To Outside		Noise Level dB(A)	Air Usage CFM
	MM	IN		MM	IN	LB	KG	MM	IN		
Pistol											
US-350PW	4	No. 8	15,000	121	4.8	1.2	0.5	17	0.7	81	7.0
US-450PW	5	No. 10	14,000	151	5.9	1.7	0.8	17	0.7	79	7.0
US-652PW	6	1/4	9,000	155	6.1	1.9	0.9	23	0.9	79	12.4
Straight											
US-6W	6	1/4	9,500	187	7.4	1.8	0.8	22.5	0.9	85	10.5
US-450WB	5	No. 10	11,000	161	6.3	1.2	0.6	18.5	0.7	80	7.0

Air Hose Size: 1/4" I.D. Air Inlet: N.P.T. 1/4"

Recommended air pressure: 57 psi for US-350PW, US-450PW, US-6W, and US-450WB / 72 psi for US-652PW.

(R) Denotes Directional Muffled Rear Exhaust option

NOTE: Additional models available. Please contact AIMCO, 1-503-254-6600, or toll free 1-800-852-1368

Tested and **PROVEN** to **BEAT** the competition in vibration and noise levels

These tools outperform the competition in number of rundowns per battery charge



## SHUT-OFF IMPACT TOOLS

The Signature Series Impact Shut-Off Pistol Tool can operate as a standard impact wrench or as an impact wrench with a programmable shut-off point, preventing over-torquing. These innovative tools deliver a torque range of 3 – 120 Nm (2 – 89 ft-lb). No torque reaction, coupled with the ergonomic, lightweight design and reduced vibration, helps to prevent user injury.

## FEATURES AND BENEFITS

- Brushless motor provides longer motor life and increased efficiency
- Easy-to-read process information lights
- Advanced shut-off system
- LED light for work-area illumination
- Programmable buttons for easy operation
- Li-Ion battery provides long battery life
- Mini USB port for connection to optional programmer (SPC-2PGM)



SIW-P5538

## SIW Signature Series Cordless Impact Tools

Model	Torque Range		Max Torque		Free Speed	Battery (V)	Weight		Anvil Size	Noise Level dB(A)
	NM	FT-LB	NM	FT-LB			LB	KG		
SIW-P2525Q	3 - 25	2 - 18	40	30	2,400	20	2.2	1	1/4 QC	71
SIW-P3225Q	6 - 32	4 - 24	90	66	2,400	20	2.2	1	1/4 QC	71
SIW-P3238	6 - 32	4 - 24	90	66	2,400	20	2.2	1	3/8 Sq Dr	71
SIW-P5538	15 - 55	11 - 41	120	90	2,400	20	2.4	1.1	3/8 Sq Dr	71
SIW-P5550	15 - 55	11 - 41	120	90	2,400	20	2.4	1.1	1/2 Sq Dr	71
SIW-P10050	25 - 100	18 - 74	180	133	2,400	20	2.4	1.1	1/2 Sq Dr	71
SIW-P12050	30 - 120	22 - 89	210	155	2,400	20	2.9	1.3	1/2 Sq Dr	71

Shut-Off Impact Tools Include: Body Jacket, Bail, and one (1) 18V Li-Ion Battery

## BATTERY AND CHARGER

The Signature Series Shut-Off Impact Tool battery features a slim profile design and a slide mount connection to the tool, which ensures durability and makes changing out batteries quick and easy.

Battery Model #	Voltage / Capacity	Type
SIW-B20LI	20V, 2.0 Ah	Li-Ion
SIW-B20LI-HC	20V, 4.0 Ah	Li-Ion

Charger Model #	Output	Input
SIW-C18-20	18 - 20V, 4.0 A	100 - 240VAC, 50-60 Hz



SIW-B20LI

SIW-B20LI-HC

SIW-C18-20

## ACCESSORIES

Model #	Description
BJ10091	Grey Body Jacket Cover
SIW-PBL	Suspension Bail
SIW-38PR	Pin Retainer Kit, 3/8" Drive
SIW-50PR	Pin Retainer Kit, 1/2" Drive



BJ10091

SIW-PBL

Quick shut-off, precision clutch minimizes torque reaction  
and ensures precise application of torque

## PRECISION CLUTCH TOOLS

Signature Series precision clutch tools feature a quick-releasing clutch that delivers accuracy across multiple joint types. Constructed of precision machined parts, this tool guarantees accuracy and durability over the life of the tool.

## FEATURES AND BENEFITS

- LED indicator provides simple process information to the operator. The signal is visible from any angle
- Press button for easy F/R operation
- LED light for working in dark areas
- Trigger repeat protection avoids double hits on already seated screws
- Easily attached sliding battery system
- Mini USB port for connection to optional programmer (SPC-2PGM)
- Li-Ion battery pack delivers longer run time
- Ergonomic handle design provides outstanding balance and weight and is ideal for accessing hard-to-reach locations
- Angle tool enables multiple head positions



SPC-P23250



SPC-A21625

## SPC Signature Series Cordless Clutch Tools

Model	Torque Range		Free Speed RPM Range (Programmable with Programmer Accessory)	Battery Voltage	Tool Weight (w/o Battery)		Anvil Size
	NM	FT-LB			LB	KG	
<b>Pistol*</b>							
SPC-P23250	.8 - 3	.6 - 2.2	500 - 1,550	18V	2.1	.95	1/4" QC
SPC-P26250	1 - 6	.7 - 4.4	300 - 1,000	18V	2.1	.95	1/4" QC
SPC-P29250	1.5 - 9	1.1 - 6.6	300 - 800	18V	2.1	.95	1/4" QC
SPC-P212250	2 - 12	1.5 - 8.8	250 - 600	18V	2.1	.95	1/4" QC
<b>Right Angle**</b>							
SPC-A210250	3 - 12	2.2 - 8.8	400 - 1,000	18V	3.5	1.6	1/4" QC
SPC-A21025	3 - 12	2.2 - 8.8	400 - 1,000	18V	3.5	1.6	1/4" Sq
SPC-A21038	3 - 12	2.2 - 8.8	400 - 1,000	18V	3.5	1.6	3/8" Sq
SPC-A216250	5 - 18	3.7 - 13.3	300 - 600	18V	3.5	1.6	1/4" hex
SPC-A21625	5 - 18	3.7 - 13.3	300 - 600	18V	3.5	1.6	1/4" Sq
SPC-A21638	5 - 18	3.7 - 13.3	300 - 600	18V	3.5	1.6	3/8" Sq
SPC-A23038	8 - 30	5.9 - 22	250 - 480	18V	3.5	1.6	3/8" Sq
SPC-A23538	10 - 35	7.4 - 25.8	220 - 330	18V	3.5	1.6	3/8" Sq
SPC-A25038	22 - 50	16.5 - 37	200 Non-Programmable Fixed Speed***	18V	5.3	2.4	3/8" Sq
SPC-A27038	30 - 70	22 - 51.7	170 Non-Programmable Fixed Speed***	18V	6.3	2.9	3/8" Sq
SPC-A210050	35 - 100	26 - 74	119 Non-Programmable Fixed Speed***	18V	7.4	3.4	1/2" Sq

\* Pistol Grip Tools include: Torque Adjustment Tool and one (1) 18V Li-Ion Battery

\*\* Angle Nutrunners include: Torque Adjustment Tool, Head Indexing Spanner Wrench, and one (1) 18V Li-Ion Battery

\*\*\* High torque tools feature fixed RPM

# Signature Series Precision Clutch Cordless Tool Accessories

## BATTERY AND CHARGER

One universal battery and charger interface with all of the Signature Series Precision Clutch tools. Each tool utilizes the same lightweight 18V Li-Ion battery, which provides superior battery life. The charger accepts input AC power of 100 – 240VAC, making use simple anywhere in the world.

### Batteries and Charger for SPC Signature Series Cordless Clutch Tools

Battery Model	Voltage	Type	Capacity	Weight
SPC-B218LI	18V	Li-Ion	2.0 Ah	.8 Lb/.4 kg
SPC-B218LI-HC	18V	Li-Ion	4.0 Ah	1.4 Lb/.64 kg

Charger Model	Output	Input	Dimensions (W/O Battery)	Weight
SPC-C218-20	18V-19.2V 3.0 A	100-240VAC 50-60 Hz	6.25" deep x 5" wide x 3.5" tall 158.75 mm x 127 mm x 89 mm	1.2 Lb/.54 kg



## PRECISION CLUTCH TOOL ATTACHMENTS

A wide variety of special heads and attachments can be fitted to Signature Series Angle Nutrunners. Contact your AIMCO representative for assistance, 1-503-254-6600, or toll free 1-800-852-1368.



## TOOL SPEED PROGRAMMER

Each Signature Series battery tool has programmable features that enhance operator efficiency.



Programmable features include:

- Tool speed control from minimum (1,500 rpm) to maximum (2,400 rpm) speed in 50 rpm increments
- Forward/Reverse Mode - Three setting options
- Two-stage trigger delay control
- Screw count / impact count
- Supervisor level "lock-out" control

Additionally, the Signature Series battery tool has an integrated mini USB connector that couples to the Signature Series Programmer module. Simply connect the tool to the Programmer Module and flash the tool to the desired RPM. The programmed RPM will remain until a change is desired.

## QUICK CLIP



The two piece Quick Clip comes with a belt clip and a stretch cord attachment for a pistol tool. The patented ball feature allows for quick and easy release.



## TOOL BASKETS

AIMCO tool baskets can be affixed to a bench or rack and can be used for either a pistol or right angle tool.

## BODY JACKETS

Prevent damage to the workpiece.

Model	Description
BJ10082	Clear Body Jacket for Signature Series Precision Clutch Pistol Tools
BJ10083	Clear Body Jacket for Signature Series Precision Clutch Angle Nutrunners

# Electric Screwdrivers

## Electra<sup>®</sup> SERIES

- Available in push-to-start and lever start styles
- Ergonomic design – Lightweight, compact housings ensure operator comfort during operation
- Accurate torque control – Precise controlled fastening with automatic shut-off clutches
- External brush replacement – Virtually no down time for brush replacement
- External torque adjustment – Torque level can be easily adjusted by simply turning the external adjustment ring



AE-5681



- UL Listed and CE Certified – Drivers meet electrical safety standards in both the U.S. and Europe
- Direct plug-in style – Offers easy and convenient start-up (certain models), simply plug it in
- State-of-the-art motor design – Ensures comfortable grip temperature for operator and extended motor life

### Electra<sup>®</sup> Series Screwdrivers

Model	Torque Range		Free Speed RPM	Weight		Length		Hex Drive		Power Source
	IN-LB	KGf-CM		LB	KG	IN	MM	IN	MM	
Push-To-Start Direct Plug-In Series										
AE-5681 (Includes torque cover)	3.5 - 15.6	4 - 18.0	1,000	1.2	0.5	9.3	237	1/4	6.4	115V AC*
AE-8681 (Includes pistol grip handle adapter)	15 - 45	23.0 - 51.8	600	1.6	0.7	10.6	269	1/4	6.4	115V AC*
Low-Voltage Lever Start Series (Requires External Power Supply)										POWER SUPPLY:
AE-2020	.35 - 1.3	.40 - 1.5	720	0.7	0.3	8.0	203	1/4	6.4	See page 129 for required power supplies
AE-4020	.9 - 5	1.0 - 6.0	720	0.7	0.3	8.0	203	1/4	6.4	
AE-4520	1.3 - 8.7	1.5 - 10.0	720	0.7	0.3	8.0	203	1/4	6.4	
AE-7010	6.1 - 17.4	7.0 - 20.0	750	1.4	0.6	9.3	236	1/4	6.4	
Low-Voltage Push-To-Start Series (Requires External Power Supply)										
AE-7010PS	6.1 - 17.4	7.0 - 20.0	750	1.4	0.6	9.3	236	1/4	6.4	

\* 220V AC is available upon request. Contact AIMCO at 1-503-254-6600, or toll free 1-800-852-1368.

### ELECTRA<sup>®</sup> LOW ESD SERIES

- Grounded bit – Grounded chuck assembly routes any existing charge to ground
- Carbonized housing – Handle material and buttons are constructed of carbonized plastic throughout, enabling any charge received by the handle to be routed to ground
- Long-Lasting ESD resistant handle – Material will maintain its integrity for the life of the handle, unlike coatings or paints



AE-5681ESD



### Electra<sup>®</sup> Low ESD Series Screwdrivers

Model	Torque Range		Free Speed RPM	Weight		Length		Hex Drive		Power Source
	IN-LB	KGf-CM		LB	KG	IN	MM	IN	MM	
AE-4520ESD*	1.3 - 8.7	1.5 - 10.0	720	0.9	0.4	8.0	204	1/4	6.4	35V DC
AE-5681ESD	3.5 - 15.6	4 - 18.0	1,000	1.2	0.5	9.3	237	1/4	6.4	115V AC**

\* Low-voltage units require an external power supply.

\*\* 220V AC is available upon request. Contact AIMCO at 1-503-254-6600, or toll free 1-800-852-1368.

# Electric Screwdrivers

## ELECTRA® SLIP CLUTCH SERIES

- High-speed performance – For quick and consistent assembly and disassembly
- Maximum ergonomics and convenience – Offers a combination of a slip clutch with a high speed motor to provide low torque reaction; one of the best power-to-weight ratios in the industry
- Added maintenance feature – LED light indicates when to change brushes. Brush cap contains a switch that shuts off the power during brush replacement
- Direct 110V plug-in – Eliminates the need for an external power supply



- 1/4" hex quick change chuck for easy bit changes
- External torque collar for easy torque adjustment.

### Electra® Slip Clutch Series Screwdrivers

Model	Recommended Torque Range		Free Speed RPM	Weight		Length		Hex Drive		Power Source
	IN-LB	KGF-CM		LB	KG	IN	MM	IN	MM	
AE-2015	4.3 - 21.7	5.0 - 25.0	1,000	1.2	.55	9.2	234	1/4	6.4	110 V / 120V AC*

\*\* 220V AC is available upon request. Contact AIMCO at 1-503-254-6600, or toll free 1-800-852-1368.

## PRECISION SERIES

- For low torque applications
- Featuring ergonomic design
- Comes with options such as long-life brushless motors and adjustable speed power supplies

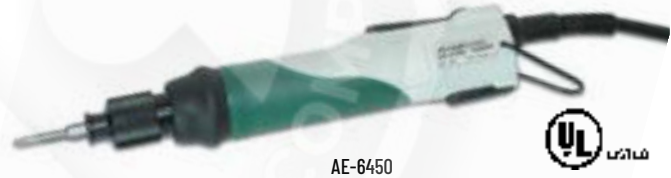

## STANDARD MODELS

- Optional speed control power supply – Enables infinite control from 20% to 100% of maximum tool speed and adjustable soft start to minimize cross threading
- Ergonomic housing – Oval shape conforms to hand
- Duralite – Casing material provides a secure grip
- Feather touch integrated lever reduces travel and stress. Requires only 2 mm of travel to activate
- External torque control – Twist and go

## EXTENDED LIFE MODELS

- Sealed Swiss motor – For higher duty cycles, longer life, and less maintenance. Sealed casing means no brush changes are necessary
- Extended warranty on tool motor – Three year standard motor warranty
- Compact power supply – Makes setup a breeze

### Electra® Precision Series Screwdrivers

Model	Torque Range		Free Speed RPM	Weight		Length		Hex Drive IN	
	IN-LB	KGF-CM		LB	KG	IN	MM		
Standard									
AE-6450	1.3 - 8.7	1.5 - 10.0	770	0.9	0.4	8.5	216	1/4	
Extended Life									
AE-6300M	1.0 - 5.5	1.1 - 6.3	550	0.9	0.4	8.5	216	1/4	



# Electric Screwdrivers



AE-224PS  
AE-278PS

APM-30

## Electra® Series Power Supplies

Model	Compatible Screwdrivers		Tool RPM	Voltage Conversion	Dimensions	Weight	
	LB	KG					
AE-224PS	AE-2020 AE-2020ESD AE-4020	AE-4520 AE-4520ESD AE-6450	720	110V AC - 220V AC 35V DC	2.6 x 1.6 x 5.0 66 x 41 x 127 mm	1.0	.45
AE-278PS	AE-7010 AE-7010PS		STANDARD	110V AC - 220V AC 30V DC	1.6 x 5.0 x 2.6 41 x 127 x 66 mm	1.0	.45
APM-30	AE-6300M		550	110V AC - 220V AC 30V DC	2.1 x 3.4 x 1.9 53 x 87 x 48 mm	0.4	0.2



## DIGITAL FASTENING COUNTER

The AM Series fastener counter verifies and error-proofs the assembly process.

- Buzzer notifies of missing screws, incomplete fastening, and thread damage
- Counts up to 60,000 units and up to 99 screws per unit
- Connects easily to automation equipment using standard input/output signals
- Large LCD screen is easy to read. A green screen indicates OK fastening, a red screen indicates NG

## Digital Fastening counters for Electra® Series Screwdrivers

Model	Compatible Screwdrivers
AM-45	For AE-2020, AE-4020, AE-4520 Standard and ESD types
AM-65	For AE-7010, AE-7010PS

## OPTIONAL ACCESSORIES



### Angle Head Attachments

Available for lever start series.  
Not available for Low ESD Series.



### Pistol Grip Handle

Converts to a pistol style driver for horizontal fastening. Available for Trigger Start only (included with AE-8681).



### Torque Cover

Prevents accidental torque adjustment by the operator (included with AE-5681).

## Electra® Series Screwdriver Accessories

Item	Model	Compatible Screwdrivers
Angle Head Attachments	AE-2045A	For AE-2020, AE-4020, AE-4520
	AE-7080A	For AE-7010
Pistol Grip Handle	AE-PG7080	For AE-7010, AE-7010PS
Torque Cover	AE-TC2040	For AE-2020, AE-4020, AE-4520
	AE-TC7080	For AE-7010, AE-7010PS
	4H2055	For AE-8681

# Impact Tools

## UW-SERIES IMPACT TOOLS

UW-Series impact tools offer fast, economical operation in high-volume heavy assembly applications.



## UW Series Twin Hammer Pistol Impact Wrenches

Recommended Air Pressure: 85 psi

Model	Capacity		Torque Range (Approx)		Speed RPM	Overall Length		Weight		From Center to Outside		Sq. Dr. or Hex Size IN	Noise Level dB(A)	Average Air Consumption
	MM	IN	NM	FT-LB		MM	IN	KG	LB	MM	IN			
UW-6SLRDK	6	1/4	6.9 - 18	5 - 13	8,500	175	6.9	1.0	2.1	31.0	1.2	1/4 Hex	91	12.4
UW-6SLRK	6	1/4	7.8 - 19	6 - 14	8,500	175	6.9	1.0	2.1	31.0	1.2	1/4 Sq.	92	12.4
UW-61ERK	8	5/16	14 - 40	10 - 30	7,300	150	5.9	1.5	3.3	29.5	1.2	3/8 Sq.	91	12.4
UW-8SHRK	8	5/16	18 - 40	13 - 30	7,300	172	6.8	1.6	3.4	31.0	1.2	1/2 Sq.	93	14.0
UW-9SRK	10	3/8	35 - 87	26 - 64	7,000	178	7.0	1.8	3.9	34.0	1.3	1/2 Sq.	93	16.0
UW-10SHRK	12	1/2	47 - 170	35 - 125	6,000	183	7.2	2.1	4.7	30.5	1.4	1/2 Sq.	95	16.0
UW-13SRK	13	1/2	88 - 250	65 - 184	6,000	215	8.5	2.6	5.7	37.5	1.5	1/2 Sq.	95	16.0
UW-131ERK	13	1/2	84 - 260	62 - 192	5,500	205	8.1	3.0	6.5	37.5	1.5	1/2 Sq.	97	19.4

Air Hose Size: 3/8" I.D. Air Inlet: N.P.T. 1/4" NOTE: Additional models available. Please contact AIMCO, 1-503-254-6600, or toll free 1-800-852-1368.



## UW Series Twin Hammer In-Line Impact Wrenches

Recommended Air Pressure: 85 psi

Model	Capacity		Torque Range (Approx)		Speed RPM	Overall Length		Weight		From Center to Outside		Sq. Dr. or Hex Size IN	Noise Level dB(A)	Average Air Consumption
	MM	IN	NM	FT-LB		MM	IN	KG	LB	MM	IN			
UW-6SSRK	6	1/4	9.8 - 26	7 - 19	7,500	225	8.9	1.0	2.1	29.5	1.2	3/8 Sq.	91	10.5
UW-6SSLRDK	6	1/4	6.9 - 18	5 - 13	8,500	239	9.4	0.9	1.9	31.0	1.3	1/4 Hex	91	10.5
UW-6SSHRDK	8	5/16	15 - 30	11 - 22	7,300	249	9.8	1.3	2.8	27.5	1.1	1/4 Hex	91	12.4
UW-6SSHRK	8	5/16	22 - 50	16 - 37	7,300	249	9.8	1.3	2.8	27.5	1.1	3/8 Sq.	91	12.4
UW-13SSK	13	1/2	89 - 250	66 - 184	6,300	281	11.1	3.2	7.0	39.0	1.5	1/2 Sq.	97	19.4
UW-401	38	1-1/2	880 - 2,500	649 - 1,844	3,200	494	19.5	15.1	33.2	62.5	2.5	1 Sq.	110	42.4
UW-401L	38	1-1/2	790 - 2,300	583 - 1,696	3,200	654	25.8	16.5	36.3	62.5	2.5	1 Sq.	110	42.4

Air Hose Size: 3/8" I.D., 1/2" I.D. for UW-401 and UW-401L models Air Inlet: N.P.T. 1/4" NOTE: Additional models available. Please contact AIMCO, 1-503-254-6600, or toll free 1-800-852-1368.

### Impact Tools Model Number Key

UW-SH = Pistol grip  
 UW-SSH = Straight handle  
 UW-CSH = Angle head  
 UW-P = Pistol grip for 140 and 381 series

+ L = Long anvil  
 + R = Rear exhaust  
 + K = Lightweight  
 + DK = Driver-type anvil, lightweight

# Impact Tools



UW-6CSHRK



UW-13CSK

## UW Series Twin Hammer Angle Impact Wrenches

Recommended Air Pressure: 85 psi

Model	Capacity		Torque Range (Approx)		Speed RPM	Overall Length		Weight		From Center to Outside		Sq. Dr. or Hex Size IN	Noise Level dB(A)	Average Air Consumption
	MM	IN	NM	FT-LB		MM	IN	KG	LB	MM	IN			
UW-6CSHRK	8	5/16	19 - 41	14 - 30	7,300	282	11.1	1.7	3.8	27.5	1.1	3/8 Sq.	94	10.5
UW-13CSK	13	1/2	75 - 200	55 - 148	6,500	374	14.7	5.2	11.4	39.0	1.5	1/2 Sq.	97	26.5

Air Hose Size: 3/8" I.D. Air Inlet: N.P.T. 1/4" NOTE: Additional models available. Please contact AIMCO, 1-503-254-6600, or toll free 1-800-852-1368.



UW-140P(WR)



UW-220P  
UW-220PL



UW-251P



UW-381  
UW-381L



UW-381P

## UW Series Swing Hammer Impact Wrenches

Recommended Air Pressure: 85 psi

Model	Capacity		Torque Range (Approx)		Speed RPM	Overall Length		Weight		From Center to Outside		Sq. Dr. or Hex Size IN	Noise Level dB(A)	Average Air Consumption
	MM	IN	NM	FT-LB		MM	IN	KG	LB	MM	IN			
UW-140P(WR)	12	1/2	70 - 210	52 - 155	6,500	200	7.9	2.7	5.9	33.0	1.3	1/2 Sq.	93	25.0
UW-220P	19	3/4	300 - 700	221 - 516	5,500	230	9.1	2.8	9.6	42.0	1.7	3/4 Sq.	95	25.0
UW-220PL	19	3/4	300 - 700	221 - 516	5,500	350	13.8	4.4	10.3	42.0	1.7	3/4 Sq.	95	25.0
UW-251P	25	1	600 - 1,000	443 - 738	5,500	276	10.9	8.0	17.6	55.0	2.0	1 Sq.	95	28.0
UW-381	38	1-1/2	760 - 2,000	561 - 1,475	4,700	395	115.6	9.5	20.9	58.5	2.3	1 Sq.	100	31.5
UW-381L	38	1-1/2	1,400 - 2,000	1,033 - 1,475	4,700	543	21.4	10.0	20.9	58.5	2.3	1 Sq.	100	31.5
UW-381P	38	1-1/2	760 - 2,000	561 - 1,475	4,700	276	10.9	10.0	20.9	58.5	2.3	1 Sq.	99	31.5

Air Hose Size: 3/8" for UW-140P(WR) 1/2" I.D. for other models NOTE: Additional models available. Please contact AIMCO, 1-503-254-6600, or toll free 1-800-852-1368.  
Air Inlet: N.P.T. 1/4" for UW-140P(WR) N.P.T. 3/8" for UW-220P and UW-251P series N.P.T. 1/2" for UW-381 series



UW-550



UW-75S

## UW Series Twin Hammer Jumbo Impact Wrenches

Recommended Air Pressure: 85 psi

Model	Capacity		Torque Range (Approx)		Speed RPM	Overall Length		Weight		From Center to Outside		Sq. Dr. or Hex Size IN	Noise Level dB(A)	Average Air Consumption
	MM	IN	NM	FT-LB		MM	IN	KG	LB	MM	IN			
UW-550	55	2-1/4	2,500 - 5,800	1,844 - 4,278	3,500	525	20.7	36.0	79.0	78.0	3.1	1-1/2 Sq.	112	79.0
UW-75S	76	3	7,800 - 17,000	5,753 - 12,539	1,400	670	26.4	56.0	123.0	96.0	3.8	1-1/2 Sq.	112	114.0

Air Hose Size: 3/4" I.D. Air Inlet: N.P.T. 1" NOTE: Additional models available. Please contact AIMCO, 1-503-254-6600, or toll free 1-800-852-1368.

## UW Series Stud Bolt Wrenches

Recommended Air Pressure: 85 psi

Model	Capacity		Torque Range (Approx)		Speed RPM	Overall Length		Weight		From Center to Outside		Sq. Dr. or Hex Size IN	Noise Level dB(A)	Average Air Consumption
	MM	IN	NM	FT-LB		MM	IN	KG	LB	MM	IN			
UW-ST6SHK	8	5/16	22 - 49	16 - 36	6,500	170	6.7	1.7	3.7	24.0	1.0	3/8 Sq.	92	14.0

Air Hose Size: 3/8" I.D. Air Inlet: N.P.T. 1/4" NOTE: Additional models available. Please contact AIMCO, 1-503-254-6600, or toll free 1-800-852-1368.



UW-ST6SHK

# Grinders



UAG-40SBL-136



UAG-50SBL-109  
UAG-50SBL-120



UAG-70SBL-76



UAG-90SBL-59

## UAG Series Angle Grinders

Recommended Air Pressure: 85 psi

Model*	Capacity (Wheel Size)	Speed RPM	Rated Horsepower HP	Overall Length		Overall Height		Weight		Noise Level dB(A)	Average Air Consumption CFM
	IN			MM	IN	MM	IN	KG	LB		
UAG-40SBL-136	4	13,600	1.0	246	9.7	76	3.0	1.3	2.9	84	34.0
UAG-50SBL-109	5	10,900	1.0	246	9.7	76	3.0	1.4	3.1	82	34.0
UAG-50SBL-120	5	12,000	1.0	246	9.7	76	3.0	1.4	3.1	82	34.0
UAG-70SBL-76	7	7,600	2.0	300	11.8	98	3.9	2.9	6.4	83	57.0
UAG-90SBL-59	9	5,900	2.5	308	12.1	98	3.9	3.3	7.3	88	67.0



## UG Series Die Grinders

Recommended Air Pressure: 85 psi

Model*	Collet Chuck Size	Speed RPM	Rated Horsepower HP	Overall Length		Weight		Noise Level dB(A)	Average Air Consumption CFM
	IN			MM	IN	KG	LB		
UG-25NA	1/4	23,500	0.3	153	6.0	0.5	1.2	82	10.7
UG-38N	1/4	25,000	0.4	164	6.5	0.6	1.3	85	10.7
UG-38NA	1/4	22,000	0.4	165	6.5	0.7	1.4	75	14.0
UG-38NL	1/4	21,000	0.4	317	12.5	0.9	2.0	85	10.7
UG-38NS	1/4	25,000	0.4	174	6.8	0.6	1.3	85	10.7
UG-50S-200	1/4	23,000	0.3	198	7.8	0.6	1.3	73	14.0
UG-45H	1/4	18,000	0.5	196	7.7	0.8	1.8	76	22.0
UG-60S-29*	1/4	2,900	0.5	227	8.9	1.1	2.3	77	18.0

\*UG-60S-29 includes spanner wrench to tighten collet

## UG Series Mini Angle Die Grinders

Recommended Air Pressure: 85 psi

Model*	Collet Chuck Size	Speed RPM	Rated Horsepower HP	Overall Length		Overall Height		Weight		Noise Level dB(A)	Average Air Consumption CFM
	IN			MM	IN	MM	KG	LB			
UG-50S-200A	1/4	20,000	0.3	195	7.7	87	3.4	0.9	2.0	75	14.0



UG-50S-200A



UG-65EB

UG-65EBL



UG-650EL

## UG Series Lightweight Grinders

Recommended Air Pressure: 85 psi

Model*	Capacity (Wheel Size)	Speed RPM	Rated Horsepower HP	Overall Length		Weight		Noise Level dB(A)	Average Air Consumption CFM
	IN			MM	IN	KG	LB		
UG-65EB	2.5	14,600	0.6	242	9.8	1.3	2.8	95	22.0
UG-65EBL	2.5	14,600	0.6	272	10.7	1.4	3.1	95	22.0
UG-650EL	2.5	14,600	0.6	420	16.5	1.6	3.4	85	22.0

## UG Series Horizontal Grinder

Recommended Air Pressure: 85 psi

Model	Capacity (Wheel Size)	Speed RPM	Rated Horsepower HP	Overall Length		Weight		Noise Level dB(A)	Average Air Consumption CFM
	IN			MM	IN	KG	LB		
UG-1250L-72	5	7,200	1.0	436	17.2	2.8	6.2	88	32.7



UG-1250L-72

\*Air Hose Size: 3/8" I.D. - 1/2" I.D. (UG-1250L-72) Air Inlet: N.P.T. 1/4" - N.P.T. 3/8" (UAG-90SBL-59 and UG-1250L-72)

NOTE: Additional models available. Please contact AIMCO, 1-503-254-6600, or toll free 1-800-852-1368.

# Sanders and Drills

## UP Series Sander

Recommended Air Pressure: 85 psi

Model	Capacity (Wheel Size)		Speed RPM	Rated Horsepower HP	Overall Length		Weight		Noise Level dB(A)	Average Air Consumption CFM
	IN	MM			MM	IN	KG	LB		
UP-25DB	5		10,000	0.3	212	8.3	1.7	3.7	73	7.0

Air Hose Size: 3/8" I.D. Air Inlet: N.P.T. 1/4" NOTE: Additional models available. Please contact AIMCO, 1-503-254-6600, or toll free 1-800-852-1368.



UP-25DB



## UD Series Drills

Recommended Air Pressure: 85 psi

Model	Capacity		Speed RPM	Overall Length		Weight With Chuck		From Center To Outside		Nominal Chuck Size IN	Type of Spindle IN-THR'D	Noise Level dB(A)	Average Air Consumption CFM
	MM	IN		MM	IN	KG	LB	MM	IN				
<b>Pistol</b>													
UD-50-200	3	1/8	23,000	135	5.3	0.7	1.5	21.0	0.8	5/16	3/8-24UNF	73	14
UD-50-45	6	1/4	5,000	145	5.7	0.9	1.9	21.0	0.8	5/16	3/8-24UNF	72	14
UD-50-22	8	5/16	2,200	140	5.5	0.9	2.0	21.0	0.8	5/16	3/8-24UNF	72	14
UD-60-29	8	5/16	2,900	167	6.6	1.1	2.4	22.5	0.9	5/16	3/8-24UNF	77	18
UD-60-20	8	5/16	2,000	180	7.1	1.2	2.6	22.5	0.9	5/16	3/8-24UNF	77	18
UD-60-15	8	5/16	1,600	180	7.1	1.2	2.6	22.5	0.9	5/16	3/8-24UNF	76	18
UD-60-07	13	1/2	700	219	8.6	1.4	3.1	22.5	0.9	1/2	1/2-20UNF	75	18
UD-60-04	13	1/2	500	220	8.6	1.4	3.1	22.5	0.9	1/2	1/2-20UNF	75	18
UD-80-12	13	1/2	1,200	216	8.5	1.8	4.0	26.0	1.0	1/2	1/2-20UNF	79	23
UD-80-07	13	1/2	700	239	9.4	2.3	5.1	26.0	1.0	1/2	1/2-20UNF	79	23
UD-80-04	16	5/8	400	247	9.7	2.9	6.4	26.0	1.0	5/8	5/8-16UNF	79	23
<b>Inline</b>													
UD-50S-45	6	1/4	5,000	210	8.3	0.9	1.9	21.0	0.8	5/16	3/8-24UNF	77	14
UD-50S-22	8	5/16	2,200	205	8.1	0.8	1.8	21.0	0.8	5/16	3/8-24UNF	77	14
UD-60S-29	8	5/16	2,900	227	8.9	1.1	2.3	22.5	0.9	5/16	3/8-24UNF	77	18
UD-60S-15	8	5/16	1,600	238	9.4	1.2	2.5	22.5	0.9	5/16	3/8-24UNF	77	18
<b>Angle</b>													
UD-50S-45A	4	#8	5,000	253	10	0.9	1.98	21.0	0.8	-	1/4-28UNF	79	14
UD-50S-45A*	4	#8	5,000	253	10	0.9	1.98	21.0	0.8	-	1/4-28UNF	79	14
UD-60S-29C	8	5/16	2,900	276	10.9	1.5	3.3	22.5	0.9	5/16	3/8-24UNF	79	18
UD-60S-15C	8	5/16	1,600	283	11.1	1.6	3.5	22.5	0.9	5/16	3/8-24UNF	79	18

\* UD-50S-45A\* comes with a cone jaw chuck installed.

Air Hose Size: 3/8" I.D.

Air Inlet: N.P.T. 1/4"

NOTE: Other models are available. Please contact AIMCO, 1-503-254-6600, or toll free 1-800-852-1368.

# Percussion Tools

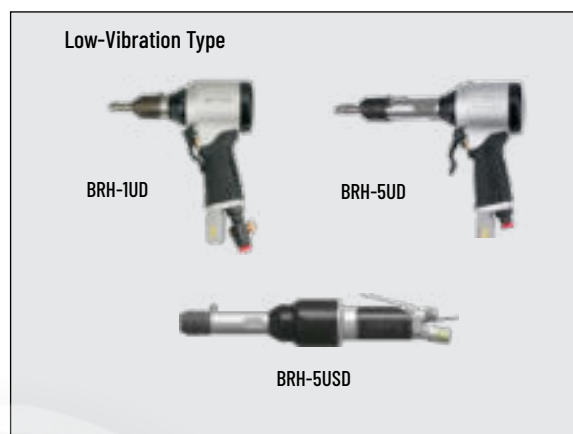
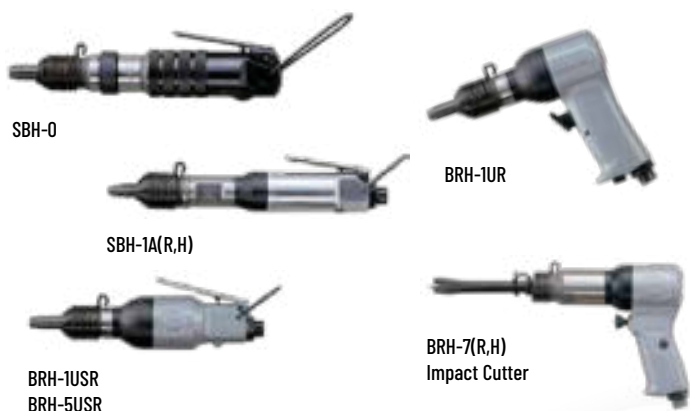

## SBH / BRH Series Riveting Hammers Impact Cutter

Recommended Air Pressure: 85 psi

Model	Capacity		Blow Per Min. BPM	Overall Length		Weight		Piston Diameter		Piston Stroke		Noise Level dB(A)	Average Air Consumption CFM
	Duralumin IN	Steel IN		MM	IN	KG	LB	MM	IN	MM	IN		
<b>Standard Type</b>													
SBH-0	#2	—	6,500	123	4.8	0.3	0.7	10.0	0.4	23	0.9	90	3.5
SBH-1A(R,H)*	#3	—	4,000	209	8.2	0.9	1.9	11.1	0.4	56	2.2	92	5.0
BRH-1UR	#5	#3	2,800	122	4.9	1.1	2.4	14.3	0.6	38	1.5	95	12.0
BRH-1USR	#5	#3	2,800	180	7.1	1.0	2.2	14.3	0.6	38	1.5	95	12.0
BRH-5USR	1/4	#10	1,800	246	9.7	1.5	3.2	12.7	0.5	100	4.0	95	13.0
<b>Low-Vibration Type</b>													
BRH-1UD(R)*	#5	#3	2,800	122	4.9	1.1	2.4	14.3	0.6	38	1.5	95	12.0
BRH-5UD(R)*	1/4	#10	1,800	189	7.4	1.4	3.1	12.7	0.5	100	4.0	95	13.0
BRH-5USD	1/4	#10	2,800	211	10.7	1.7	3.6	12.7	0.6	100	1.5	95	12.0
<b>Impact Cutter</b>													
BRH-7(R,H)*	—	—	3,400	168	6.6	1.6	3.6	19.1	0.8	50	2.0	100	17.0

Air Hose Size: 3/8" I.D. Air Inlet: N.P.T. 1/4" \* R - Round Bushing H - Hex Bushing



## CB / RH Series One Shot Hammers

Recommended Air Pressure: 85 psi

Model	Blow Power LB	Rivet Set Dia x Length IN	Shank Diameter		Stroke		Length		Weight	
			MM	IN	MM	IN	MM	IN	LB	KG
RH-25	20.4	—	10.2	0.401	29.8	1.2	213	8.4	2.0	0.9
RH-80	27.6	—	10.2	0.401	29.8	1.2	254	10.0	2.9	0.3
RH-90	103	—	10.2	0.401	29.8	1.2	328	12.9	3.5	1.6
RH-100Z	78.1	—	10.2	0.401	29.8	1.2	328	12.9	3.9	1.8
RH-200	139	—	10.2	0.401	39.8	1.2	341	13.4	4.6	2.1

Air Hose Size: 3/8" I.D. Air Inlet: N.P.T. 1/4" NOTE: Additional models available. Please contact AIMCO, 1-503-254-6600, or toll free 1-800-852-1368.

# A-50 Screw Presenters

For semi-automated assembly, look no further than AIMCO's Acra-Feed screw presenters

## Productive

- One-hand operation eliminates manual handling of screws. Screw is presented to operator for easy magnetic or vacuum pickup
- Keeps workspace clear of dropped fasteners and stray fasteners from getting into assemblies
- Large hopper holds approximately 1,000 - 1,500 fasteners, and the oscillating hopper design provides a quick feed rate – up to two (2) screws per second
- Solid design – no tie downs or straps required
- Perfect for contract or dedicated assembly
- Switch rails in minutes for different screw sizes

## Ergonomic

- Allows for fewer arm and hand movements

## Reliable

- Heavy duty industrial design
- Modular design for easy repairs

## Quality

- Uses existing or our new torque control drivers



Acra-Feed® Screw Presenter



## FASTENING IN 3 EASY STEPS



1  
Load screws into the hopper. There is no side to load unit and no gates to limit capacity.



2  
Address screw with magnetized bit.



3  
Bring screw to workpiece and fasten parts.



A-50B-1  
Standard Screw Presenter



A-50BRBTC-4  
Compact Robotic Screw  
Presenter



A-50BRBT-1  
Robotic Screw  
Presenter

## A-50 Standard Screw Presenters

For manual assembly stations where the operator must otherwise pick up and hold fasteners by hand.

Model	Additional Rail Part No.	Screw Size		Max Screw Length	
		IN	MM	IN	MM
A-50A-0	AR-0	#0	1.4	.39	10
A-50A-1.7	AR-1.7	-	1.7	.39	10
A-50B-1	BR-1	#1	2.0	.75	18
A-50B-2	BR-2	#2	2.3	.75	18
A-50B-3	BR-3	#3	2.6	.75	18
A-50B-4	BR-4	#4	3.0	.75	18
A-50C-6	CR-6	#6	3.5	.75	18
A-50C-8	CR-8	#6-8	4.0	.75	18
A-50C-10	CR-10	#10	5.0	.75	18

Dimensions: 5.1 (W) x 8.5 (L) x 5.3 (H) Weight: 7.0 lb.

## Optional Accessories

Model	Part No.
Mag-0-Net Bit Magnetizer	AM1/4Z, AM5Z, AM3/16Z, AM5/16Z

## A-50ARBTC Compact Robotic Screw Presenters

For automated systems or manual systems using vacuum-assist to pick up nonferrous fasteners when work space is limited.

Model	Additional Rail Part No.	Nominal Screw Size		Max Screw Length	
		IN	MM	IN	MM
A-50ARBTC-0	AR-RBTC-0	#0	1.4	.390	10
A-50ARBTC-1.7	AR-RBTC-1.7	-	1.7	.390	10
A-50BRBTC-1	BR-RBTC-1	#1	2.0	.700	18
A-50BRBTC-2	BR-RBTC-2	#2	2.3	.700	18
A-50BRBTC-3	BR-RBTC-3	#3	2.6	.700	18
A-50BRBTC-4	BR-RBTC-4	#4	3.0	.700	18
A-50CRBTC-6	CR-RBTC-6	#6	3.5	.700	18
A-50CRBTC-8	CR-RBTC-8	#6-8	4.0	.700	18
A-50CRBTC-10	CR-RBTC-10	#10	5.0	.700	18

Dimensions: 7.2 (L) x 4.9 (W) x 5.7 (H) Weight: 6.7 lb.

## A-50ARBT Robotic Screw Presenters

For automated fastening systems or manual systems using vacuum assist to pick up non-ferrous fasteners.

Model	Additional Rail Part No.	Screw Size		Max Screw Length	
		IN	MM	IN	MM
A-50ARBT-0	AR-RBT-0	#0	1.4	.39	10
A-50ARBT-1.7	AR-RBT-1.7	-	1.7	.39	10
A-50BRBT-1	BR-RBT-1	#1	2.0	.70	18
A-50BRBT-2	BR-RBT-2	#2	2.3	.70	18
A-50BRBT-3	BR-RBT-3	#3	2.6	.70	18
A-50BRBT-4	BR-RBT-4	#4	3.0	.70	18
A-50CRBT-6	CR-RBT-6	#6	3.5	.70	18
A-50CRBT-8	CR-RBT-8	#6-8	4.0	.70	18
A-50CRBT-10	CR-RBT-10	#10	5.0	.70	18

Dimensions: 5.1" (W) x 10.8" (L) x 5.3" (H) Weight: 9.2 lb.

# Acra-Feed Automatic Screw Feed Systems

Reduces Cycle Time By Approximately Two Seconds Per Fastener

## FEATURES AND BENEFITS

- Delivers fastener directly to the driver
- For #2 - #10 fasteners, up to 1 inch long
- Available for captive washer type screws (A315V)
- Feed speed of up to 1 screw per second
- System includes feeder, hose assembly, air screwdriver, and FRL

### Productive

- Eliminates reaching for fasteners
- Most jams are easily cleared on the line
- Frees operator's hand for productive use
- Large hopper holds between 1,000 - 5,000 fasteners

### Ergonomic

- Eliminates manual handling of fasteners and shavings
- Reduces workspace clutter
- Keeps workspace clean of dropped fasteners
- Torque reaction of standard driver is minimal and can be eliminated with optional Ergo-Arm

### Reliable

- Longest warranty in the industry – 3 years
- Rocking Bar design only operates as needed
- "Photo eyes" maximize motor life
- Design eliminates burrs and shavings by minimal handling of the fastener
- Durable head assembly lasts for years
- There are more Acra-Feed systems in use than any other system



## Acra-Feed Screw Feed Systems

Model	Applicable Screws	Screw Length		Hopper Capacity	Max Fastening Speed	Weight (Lb)	Dimensions L x W x H (In)
		IN	MM				
A2100 Series	M2-M5 (#2 - #10)	1/4-1	6-25	1,500cc (1,000-5,000 pcs)*	60 screws/min*	68	7 x 17 x 16
A315V Series	M2-M5 (#2 - #10)	1/4-1	6-25	450cc (500-2,500 pcs)*	60 screws/min*	74	10 x 21 x 16

\* Dependent on screw size

Delivery Hose: 10 ft    Air Pressure: 85 psi    Power: AC 110V, 20W, AC 220V by request. Contact AIMCO at 1-503-254-6600, or toll free 1-800-852-1368.

**HOW TO ORDER:** Acra-Feed systems are application-specific and configured to the unique workpiece and requirements of the user. Quotations are provided from a review of sample workpieces, 25 fasteners, and required torque specifications.



# Ergo Arm Tool Support Systems

## ERGO ARMS

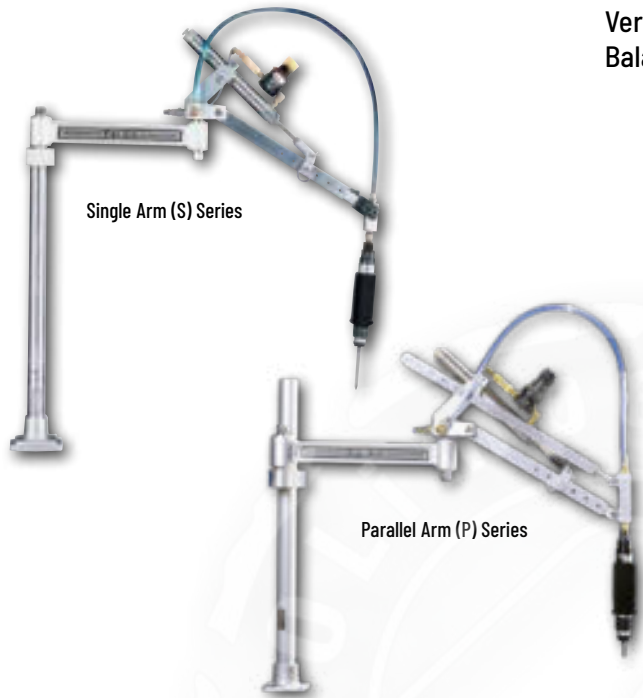

### Versatile Ergo Arms Absorb Torque Reaction while Perfectly Balancing Tool Weight

AIMCO's Ergo Arms reduce operator fatigue for electric and pneumatic tools. The versatile, easy-to-assemble kits include both single and parallel rails for customizing tool rigidity to the customer's preference.

The durable, lightweight construction provides minimal resistance and low inertia during high-cycle use. The adjustable height, length, and elbowed joint increases accessibility with minimal travel to the fastening application.

#### Tools recommended for use with this arm:

- AcraDyne 1000 and 2000 Series
- Uryu LT Series Pneumatic Screwdrivers
- Electra Electric Screwdrivers
- Inline Tools

## SPECIAL FEATURES OF ERGO ARMS

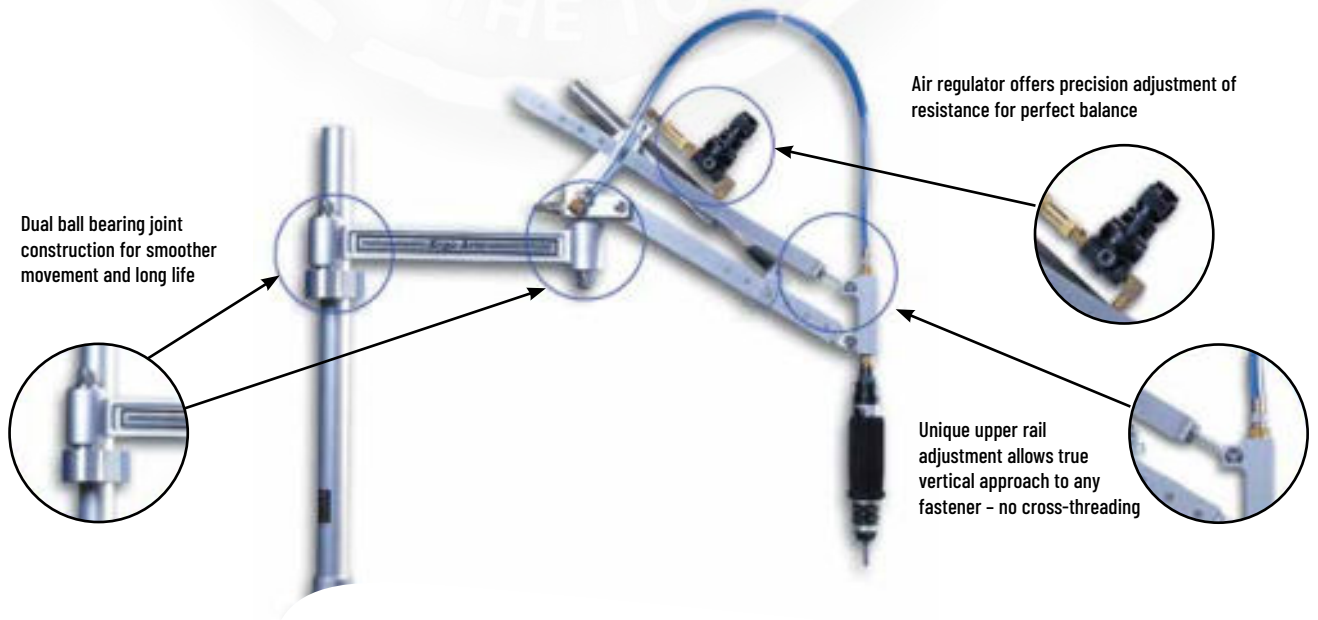

# Ergo Arm Tool Support Systems

## ERGO ARM FEATURES AND BENEFITS



### PARALLEL ARM SERIES

#### AD-D1098-P, AD-D1098-PAC, AD-D1098-PACE

- Allows for freedom of movement
- Vertical adjustment eliminates cross-threading
- Fixtured tool increases repeatability
- Adjustable reach
- Available in air or oil cylinder models
- Electric tool mount standard on PACE model

### SINGLE ARM SERIES

#### AD-D1098-S, AD-D1098-SAC

- Full tool rotation
- Allows for freedom of movement
- Adjustable reach
- Compatible with automatic screw feeder
- Available in air or oil cylinder models

## AD Series Ergo Arms

Model	Arm Style	Tool Mount	Reach		Capacity		Maximum Torque*	
			IN	MM	LB	KG	IN-LB	NM
<b>AIR CYLINDER SERIES</b>								
AD-D1098-SAC	Single	Air manifold	4 - 33	102 - 838	0 - 15	0 - 7	110	12
AD-D1098-PAC	Parallel	Air manifold	4 - 33	102 - 838	0 - 15	0 - 7	110	12
AD-D1098-PACE	Parallel	Electric	4 - 33	102 - 838	0 - 15	0 - 7	110	12
<b>OIL CYLINDER SERIES</b>								
AD-D1098-S	Single	Air manifold**	4 - 33	102 - 838	0 - 15	0 - 7	110	12
AD-D1098-P	Parallel	Air manifold	4 - 33	102 - 838	0 - 15	0 - 7	110	12

\* Max torque allowed may be dependent on tool clutch type and joint rate

\*\* For single arm electric tool mount, order EAP-202ED-KIT

# Carbon Torque Arms

## ACA SERIES TELESCOPIC CARBON ARMS



Telescopic Torque Reaction Arms Provide Complete Ergonomics in the Hand-Tightening Phase

ACA Series Carbon Arms are lightweight, yet strong devices designed to absorb torque reactive forces. Highly flexible and modular, they adapt to a wide range of tools, and eliminate hazards to operators during fastening processes.

Tools recommended for use with this arm:

- Continuous Drive Electric and Pneumatic Tools
- Pulse Tools
- Screwdrivers

## FEATURES AND BENEFITS

- Absorb torque reaction from continuous drive tools
- Counter balance tool weight when configured with AIMCO's wide array of tool balancers or with integrated balancer kits
- Orient tool correctly to the workpiece to improve efficiency and reduce operator effort in alignment to the fastener



### ACA Series Carbon Torque Arms

Model	Min. Length MM	Max. Length MM	Max Torque NM
ACA10-1000	495	1,105	10
ACA10-1500	665	1,605	10
ACA15-1000	486	1,066	15
ACA15-1500	646	1,556	15
ACA15-2000	806	2,046	15
ACA40-1000	486	1,066	40
ACA40-1500	646	1,556	40
ACA40-2000	806	2,046	40
ACA40-2500	986	2,576	40
ACA80-1500	658	1,586	80
ACA80-2000	828	2,078	80
ACA80-2500	998	2,588	80
ACA150-1500	668	1,578	150
ACA150-2000	838	1,918	150
ACA150-2500	1003	2,248	150
ACA220-1500	668	1,578	220
ACA220-2000	838	2,088	220
ACA220-2500	1,003	2,588	220

### ACA-V Series Carbon Torque Arms

Model	Min. Length MM	Max. Length MM	Max Torque NM
ACA-V15-1000	777	1,345	15
ACA-V15-1500	937	1,835	15
ACA-V15-2000	1,097	2,325	15
ACA-V40-1000	777	1,345	40
ACA-V40-1500	937	1,835	40
ACA-V40-2000	1,097	2,325	40
ACA-V40-2500	1,277	2,855	40
ACA-V80-1500	949	1,865	80
ACA-V80-2000	1,119	2,357	80
ACA-V80-2500	1,289	2,867	80
ACA-V150-1500	960	1,957.5	150
ACA-V150-2000	1,129	2,357	150
ACA-V150-2500	1,294	2,862	150
ACA-V220-1500	960	1,957.5	220
ACA-V220-2000	1,129	2,357	220
ACA-V220-2500	1,294	2,867	220

# Carbon Torque Arms

## ACA-P2 CARBON SMART ARM



ACA-P240-2500

### ACA-P2 Series Carbon Torque Smart Arm w/X,Y Axis Encoders

(Requires ACA-POSIX System or AcraDyne's Gen IV Smart Arm System)

Model	Min. Length MM	Max. Length MM	Max Torque NM
ACA-P215-1000	647	1,227	15
ACA-P215-1500	803	1,713	15
ACA-P215-2000	977	2,227	15
ACA-P240-1000	647	1,227	40
ACA-P240-1500	803	1,713	40
ACA-P240-2000	977	2,227	40
ACA-P240-2500	1,157	2,737	40
ACA-P280-1500	830	1,757	80
ACA-P280-2000	1,000	2,249	80
ACA-P280-2500	1,169	2,760	80
ACA-P2150-1500	839	1,749	150
ACA-P2150-2000	1,009	2,087	150
ACA-P2150-2500	1,174	2,419	150
ACA-P2220-1500	839	1,749	220
ACA-P2220-2000	1,009	2,259	220
ACA-P2220-2500	1,174	2,760	220



### Balancer Kits for ACA-P2 Series Carbon Torque Smart Arms

Model	Min. Capacity KG	Max. Capacity KG
ACA-P2BK-4	2	4
ACA-P2BK-6	4	6
ACA-P2BK-8	6	8
ACA-P2BK-10	8	10
ACA-P2BK-14	10	14

## Encoder Options for ACA-P2 Smart Arm

### AcraDyne Gen IV Smart Arm System With Process Visualization

AcraDyne's Gen IV controller with smart arm capability and process visualization provides an advanced error-proofing solution to ensure the quality of your fastening operation. The capability is integrated into the Gen IV controller – no need for an external PC or software. See page 16 for more details.



#### FEATURES AND BENEFITS

- Easy to follow visual guidance directly on the Gen IV controller graphical screen
- Easy to program and set up
- Low cost solution vs. competitive offerings
- Modular – can be added at any time to an existing AcraDyne system using the Gen IV controller

### ACA-POSIX Positioning System

The compact, self-contained ACA-Posix process visualization system guides operators through their assigned tasks. It connects to ACA-P2 series arms with integrated balancer kits.



#### FEATURES AND BENEFITS

- Intuitive and simple programming on 7" color LCD touch-screen display
- Store up to 500 unique assembly sequences
- Communicates directly with Power Tool controllers over digital I/O
- Store and display product images or CAD drawings. Images/drawings are displayed with targeting sequences to direct operators easily through their task
- Output for synchronizing with line controls

# Carbon Torque Arms

## TOOL HOLDERS FOR TELESCOPING CARBON ARMS

### Tool Holders For AcraDyne Tools

Model	Description
ACAH-40PS1000	Tool holder for carbon fiber arm, AcraDyne 1000 series pistol/straight tools, 40 Nm
ACAH-80PS3-5000	Tool holder for carbon fiber arm, AcraDyne 3000/5000 series pistol/straight tools, 80 Nm
ACAH-150PS3-5000	Tool holder for carbon fiber arm, AcraDyne 3000/5000 series pistol/straight tools, 150 Nm

### General Tool Holders

	Model	Description	Min. Tool Grip MM	Max. Tool Grip MM
For Telescoping Arms				
Base Tool Holders				
	ACAH-15	Base tool holder 4 screws	27	45
	ACAH-40-80	Base tool holder 4 screws	30	60
	ACAH-150-220	Base tool holder 4 screws	40	70
Multi-Position Tool Holders				
	ACAH-15-MPE2745	Multi-position tool holder interface	27	45
	ACAH-150220-MPE4070	Multi position tool holder	40	70
	ACAH-4080-MPE2745	Multi-position tool holder	27	45
Swivel Tool Holders				
	ACAH-SI54080	Swivel tool holder 20 to 35 mm	20	35
	ACAH-SI15150	Swivel tool holder 40 to 55 mm	40	55

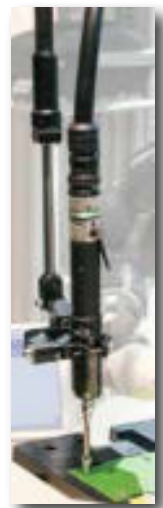

# Carbon Torque Tubes

## ACTT & ACPTT SERIES CARBON TORQUE TUBES



ACPTT Series  
Anti-Rotation Torque Tube  
with articulation support



ACTT Series  
Anti-Rotation Torque Tube

Carbon Torque Tubes Are Universal Arms With an Exclusive Design For Maximum Tightening Flexibility

ACCT and ACPTT series carbon torque tubes provide smooth and accurate tool travel from bearing splined shaft construction. These sturdy arms are available in torque ranges of 15 – 80 Nm. They can be used with a variety of tool holders.

Tools recommended for use with this arm:

- Continuous Drive Electric and Pneumatic Tools
- Pulse Tools



ACTT-V40-850 300

### FEATURES AND BENEFITS

- Universal arm with an exclusive design for maximum tightening flexibility
- Provides articulated anti-rotation support when torque reaction is parallel to arm axis

### ACTT Series Carbon Torque Tubes

Model	Min. Length Mm	Max. Length MM	Max Torque NM
ACTT-V15-600 150	150	600	15
ACTT-V15-800 300	300	800	15
ACTT-V40-600 150	150	600	40
ACTT-V40-850 300	300	850	40
ACTT-V40-1500 600	600	1,500	40
ACTT-V80-900 300	300	900	80
ACTT-V80-1500 600	600	1,500	80
ACTT-V80-2100 900	900	2,100	80

# Carbon Torque Tubes

## ACPTT SERIES CARBON TORQUE TUBES FOR ACSA ARTICULATING SUPPORT ARMS

### ACPTT TORQUE TUBES



#### FEATURES AND BENEFITS

- ACPTT arm designed for use with the ACSA articulating support arm
- ACPTT carbon torque tube provides articulated anti-rotation support when torque reaction is parallel to arm axis
- The ACPTT/ACSA articulating support arm system allows torque reaction arm installation when the workplace can't accommodate suspended overhead structures

#### ACPTT Torque Tubes

Model	Min. Length MM	Max. Length MM	Max Torque NM
ACPTT-V15-510 150	150	600	15
ACPTT-V15-710 300	300	800	15
ACPTT-V40-510 150	150	600	40
ACPTT-V40-760 300	300	850	40
ACPTT-V40-1410 600	600	1,500	40
ACPTT-V80-810 300	300	900	80
ACPTT-V80-1410 600	600	1,500	80



### ACSA ARTICULATING SUPPORT ARM



#### ACSA Articulating Support Arms

Model	Max Reach MM	Max Height MM	Max Torque NM
ACSA-600-1500	600	1,500	80
ACSA-800-1500	800	1,500	80
ACSA-1000-1500	1,000	1,500	80

\* Support arm, torque tube, balancer, tool holder, and tool shown for concept.

Items sold separately

### ACAHTT Tool Holders For ACTT & ACPTT Anti-Rotation Carbon Arms

	Model	Description	Min. Tool Grip MM	Max. Tool Grip MM
 <p>Straight</p>  <p>Angle</p>	ACAHTT-15A-3060	Angle Tool Holder, 15 Nm Arm	30	60
	ACAHTT-15S-2745	Straight Tool Holder, 15 Nm Arm	27	45
	ACAHTT-4080A-3165	Angle Tool Holder, 40/80 Nm Arms	31	65
	ACAHTT-40S-2745	Straight Tool Holder, 40/80 Nm Arms	27	45

# GCI Torque Reaction Arms

## GCI ARTICULATING TORQUE ARMS



### Rugged Flexibility for Even the Most Complex Torque Applications

Constructed of durable aluminum, steel, or carbon fiber, GCI Torque Arms are available with multiple tool mounting options for application specifics. These highly ergonomic and user friendly arms are available in torque ranges of 150 Nm to 7,500 Nm and with reaches ranging up to 20 ft.

GCI arms can be designed as Smart Arms with two encoder options: PC-based AdaptiCS software (see page 146) and AcraDyne's Gen IV smart arm system with process visualization (see page 16). This complete Smart Arm system error-proofs even the most complex torque applications.

#### Tools recommended for use with this arm:

- AcraDyne 3000 - 9000 Series HT tools
- Angle (AEN 5000 series only)
- Straight (AES)
- Axial (AEJ)
- Pistol (AEP)
- Fixtured (AEF)

## FEATURES AND BENEFITS

- Available in aluminum, steel, or carbon fiber
- Configurable installation: floor mount, wall mount, overhead mount, bench mount, or portable base
- Braking options: manual/automatic, discrete braking with verification, parking brakes, and electric/pneumatic actuation
- Tool holding options: fixed position, gimbal mount
- Integrated tool start/brake actuation capability: tool trigger start, remote tool start
- Smart Arm Capabilities:
  - Available with as many as six encoders to monitor all desirable tool positions relative to application
  - Two encoder options:
    - ▶ AcraDyne Gen IV Smart Arm System with Process Visualization (see page 16)
    - ▶ AdaptiCS PC-based software that runs on an integrated industrial PC or on a customer supplied PC (see page 146)

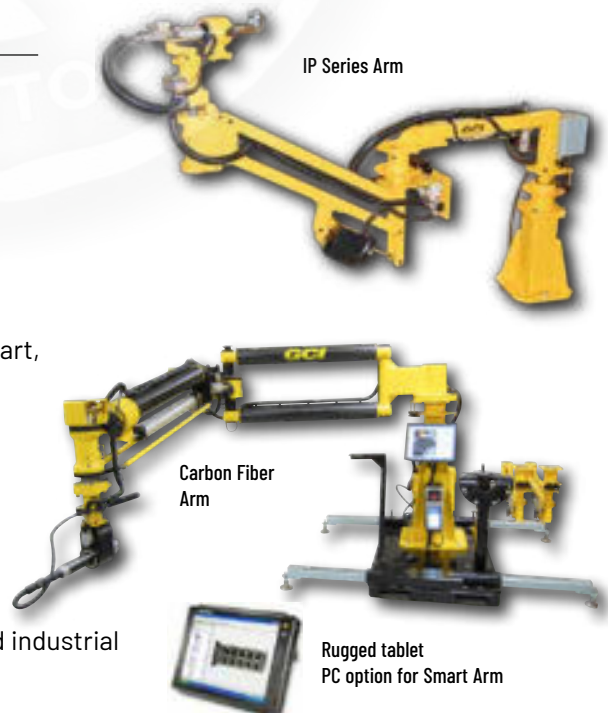



# GCI Torque Reaction Arms

## GCI Torque Reaction Arms

Model	Max. Torque	Max. Tool Weight	Max. Reach	Max. Vertical Travel	Construction
<b>IPT Series - Torques to 375 Nm</b>					
IPT150	150 Nm	12 lb	5 ft	30 in	Aluminum
IPT375	375 Nm	50 lb	6 ft	36 in	Steel
<b>IP Series - Torques to 4,000 Nm</b>					
IP4	550 Nm	30 lb	8 ft	48 in	Steel
IP5	1,000 Nm	50 lb	12 ft	60 in	Steel
IP7	3,000 Nm	100 lb	12 ft	60 in	Steel
IP8T	4,000 Nm	100 lb	12 ft	72 in	Steel
<b>F Series - Carbon Fiber Arms</b>					
F70	70 Nm	10 lb	3 ft	18 in	Carbon Fiber Composite
F600	600 Nm	50 lb	20 ft	72 in	Carbon Fiber Composite
F1500	1,500 Nm	50 lb	20 ft	72 in	Carbon Fiber Composite
F3000	3,000 Nm	75 lb	20 ft	72 in	Carbon Fiber Composite
F7500	7,500 Nm	75 lb	12 ft	72 in	Carbon Fiber Composite

## GCI ARM OPTIONS



### Additional Smart Arm Features

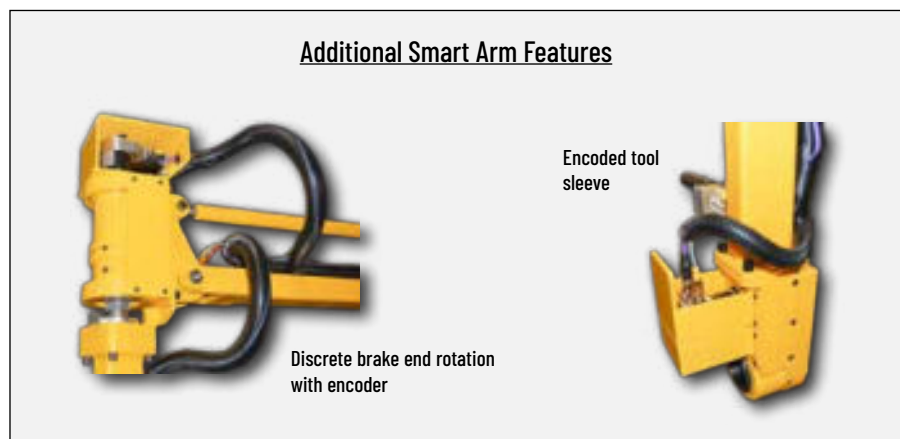

# GCI Torque Reaction Arms

## Encoder Options for GCI Smart Arms

### AcraDyne Gen IV Smart Arm System with Process Visualization

AcraDyne's Gen IV controller with smart arm capability and process visualization provides an advanced error-proofing solution to ensure the quality of your fastening operation. The capability is integrated into the Gen IV controller – no need for an external PC or software. See page 16 for more details.

#### FEATURES AND BENEFITS

- Easy to follow visual guidance directly on the Gen IV controller graphical screen
- Easy to program and set up
- Low cost solution vs. competitive offerings
- Modular – can be added at any time to an existing AcraDyne system using the Gen IV controller



### AdaptiCS Software

Intuitive, user-friendly AdaptiCS PC-based software that runs on an integrated industrial PC or on a customer supplied PC. Smart arms guide the operator in programmable torque patterns and count fasteners required for correct assembly.

#### FEATURES AND BENEFITS

- Batch count capabilities
- Bidirectional arm articulation tracking
- Full torque/angle results display
- Integrates into any line control (PLC, MES, etc.)
- Multiple part locate strategies (1-point, 2-point, 3-point)
- Multiple rework strategies to fit requirements
- Fully programmable dynamic display with integrated PC option
- Integrates devices such as torque controllers via open protocol, encoded GCI torque reaction arms, scanners, vision cameras, and digital IO (pass/fail)
- AdaptiCS Enterprise (optional) provides full line control, interlocks, and data collection
- Runs on Windows 7, 8, and 10



# 3arm Zero Gravity Arms

## 3arm ZERO GRAVITY ARMS



Strong and Dependable, 3arm Ergonomic Arms Provide Full Range of Motion to Complete any Task Efficiently and Safely

Designed to keep tools and devices weightless even in difficult positions and working areas, 3arms are available with more than 29 head configurations. Add in various available accessories, and the arms can be fixed in almost any position. More than 1,000 standard combinations are available, as well as customized solutions.



Tools recommended for use with this arm:

- Tools that have sufficient mass for counter balancing and where overhead suspension is not an option

## FEATURES AND BENEFITS

- Eases use of larger, higher weight tools, eliminating the hazards of operators having to physically carry the loads.
- Durable closed-case design absorbs considerable force
- Eliminates tool weight, providing not only an ergonomic benefit, but also increasing productivity
- Reduces operator fatigue and the chance of injury due to strain
- Holds any tool up to 77 lbs, keeping the tool weightless, while eliminating possible damage caused by dropping the tool
- Can be base-mounted, ceiling-mounted, or wall-mounted. Easily add precision reach by applying a rail, make it mobile with a trolley, or adding vertical reach with a mounting column
- Available with tool trigger braking. Effortlessly position the tool, stop it in place, release trigger, and float it to the next job

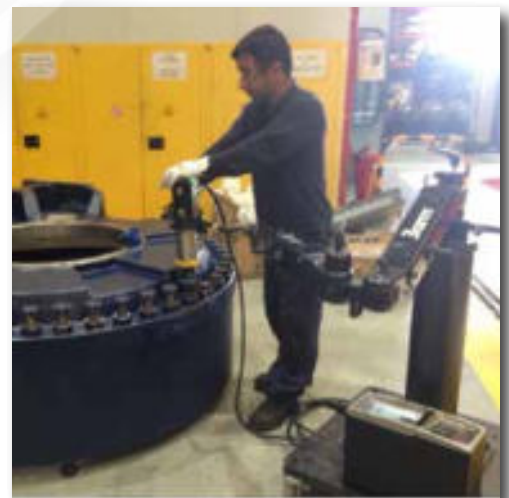

# 3arm Zero Gravity Arms

## 3arm Series 1



<b>Reach</b>	<b>Max Weight</b>
Vertical: 44 in Horizontal: 42 in	22 lb

Model	Orientation	Reach (IN)		Max Weight LB
		Vert.	Horiz.	
1SNIDS	Floor Mounted	42	44	22
1AMIDS	Ceiling Mounted	42	44	22

Compatible Head Members (see page 151): B, BA, C, E, EA, F, G, K, N, T

Brake Options	
L00	Not Required

To build your 3arm, choose the following

Arm Model	Head Member	Brake Option

Light and nimble, capable of reaching even the most difficult applications.

## 3arm Series 2



<b>Reach</b>	<b>Max Weight</b>	<b>Max Torque</b>
Vertical: 22 in Horizontal: 34 in	13 lb	120 Nm 88 ft-lb

Model	Orientation	Reach (IN)		Max Weight LB
		Vert.	Horiz.	
BB	Floor Mounted	22.2	33.9	13
BE	Ceiling Mounted	22.2	33.9	13
BA	Ceiling Mounted	22.2	33.9	13

Compatible Head Members (see page 151): B, BA, C, E, EA, F, G, K, N

Brake Options	
L00	Not Required

To build your 3arm, choose the following

Arm Model	Head Member	Brake Option

Combination radial arm and tilting arm, each capable of 360° rotation. Two arms of different lengths give you the ability to reach separate working areas.



# 3arm Zero Gravity Arms

## 3arm Series 3



**Reach**  
Vertical: 42 in  
Horizontal: 68 in

**Max Weight**  
77 lb

**Max Torque**  
650 Nm  
479 ft-lb

Versatile arm with a long reach and the ability to carry a heavy load. Features “turning and tilting” brake locking systems (pneumatic or manual), allowing the operator to immobilize the arm in a fixed position on all axes simultaneously or separately.

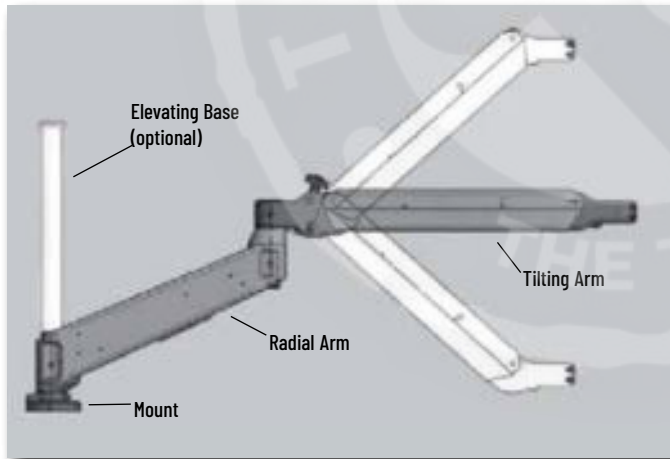

Model	Orientation	Reach (IN)		Max Weight LB
		Vert.	Horiz.	
<b>Floor Mounted</b>				
PSBS	Short Rad. + Short Tilt.	27.8	41.7	77
PSBM	Short Rad. + Long Tilt.	44.5	53.5	40
PLBS	Long Rad. + Short Tilt.	27.8	55.9	77
PLBM	Long Rad. + Long Tilt.	44.5	67.6	40
<b>Ceiling Mounted</b>				
PEBS	Short Rad. + Short Tilt.	27.8	41.7	77
PEBM	Short Rad. + Long Tilt.	44.5	53.5	40
ASBS	Long Rad. + Short Tilt.	27.8	55.9	77
ASBM	Long Rad. + Long Tilt.	44.5	67.6	40
<b>Elevating Base</b>				
ALBS	Elevating+ Short Tilt.	27.8	43.7	77
ALBM	Elevating+ Long Tilt.	44.5	55.8	40

Compatible Head Members (see page 15): All

Brake Options	
L00	Not Required
L1	Manual
L22	Pneumatic
L50	Manual Locking Base
L92	Tool Trigger Activated

To build your 3arm, choose the following

Arm Model	Head Member	Brake Option

# 3arm Zero Gravity Arms

## 3arm Series 4



**Reach**  
Vertical: 54 in  
Horizontal: 58 in

**Max Weight**  
53 lb

**Max Torque**  
300 Nm  
221 ft-lb

Model	Orientation	Reach (IN)		Max Weight LB
		Vert.	Horiz.	
DS	Floor Mounted, Short Arm	42.3	48	53
DM	Floor Mounted, Long Arm	55.5	57.5	43
ADS	Ceiling Mounted, Short Arm	42.3	48	53
ADM	Ceiling Mounted, Long Arm	55.5	57.5	43

Compatible Head Members (see page 151): All

Dual-tilting arms expand range of movement. The innovative connections between the parts of the arm allow completely free movement of rolling up, down, and sideways. Capable of reaching the most difficult positions or work with weightless precision.



### Brake Options

L00	Not Required
L11	Manual
L22	Pneumatic
L50	Manual Locking Base
L92	Tool Trigger Activated

To build your 3arm, choose the following

Arm Model	Head Member	Brake Option

## 3arm Series 6



**Reach**  
Vertical: 26 in  
Horizontal: 82 in

**Max Weight**  
42 lb

Model	Description	Reach (IN)		Max Weight LB
		Vert.	Horiz.	
BPRASC	Model 800	26	68	42
BPRASM	Model 1200	26	82	26

Compatible Head Members (see page 151):  
BPRASC - All  
BPRASM - N,T

Extendable arm with ball linear guideways attached to a pendulum base arm, both capable of 360° rotation. This compact arm offers versatility for any type of tool. The telescopic top arm allows the user to work on hard-to-reach areas comfortably, quickly and safely. Works in a wide variety of applications.



### Brake Options

L00	Not Required
-----	--------------

To build your 3arm, choose the following

Arm Model	Head Member	Brake Option

# 3arm Zero Gravity Arms

## 3arm Head Members

Once you've determined the tools that will be used in you application, select a head member based on the type of application and necessary orientations.

<b>B</b>  Vertical Flat	<b>BA</b>  Vertical with Ring	<b>C</b>  Vertical Adjustable	<b>E</b>  Flat Articulated	<b>EA</b>  Flat Articulated with Ring	<b>F</b>  Articulated Adjustable	<b>G</b>  Quick Change
<b>H</b>  Heavy-Duty Applications	<b>J</b>  Magnetic Articulated Drill	<b>K</b>  Universal Strap	<b>LA</b>  Vertical Pneumatic Ball & Socket	<b>M</b>  Constant Pressure Support	<b>N</b>  Multiposition Articulated	<b>P</b>  Double Articulated Flat
<b>Q</b>  Heavy-Duty Multiposition Articulated	<b>RA</b>  Swing Revolver	<b>RB</b>  Revolver Pistol	<b>RC</b>  Vertical & Horizontal	<b>R</b>  Revolver	<b>SN</b>  Giraffe Multiposition	<b>SQ</b>  Heavy-Duty Giraffe Multiposition
<b>SR</b>  Giraffe Revolver	<b>T</b>  Multiposition Articulated Pistol	<b>U</b>  Heavy-Duty Multiposition Articulated Pistol	<b>Z</b>  Fork			

## 3arm Brake Options



**L11**  
Manual Brakes  
Manually turned handle



**L22**  
Pneumatic Brakes



**L50**  
Manual Locking Base  
Handle at base only



**L92**  
Tool Trigger Activated Brake  
Pneumatic, activated through the tool

# Support System Tool-Mounting Options

## TOOL MOUNTING OPTIONS



AIMCO provides many head and mounting options to fit almost any application. Find more information in our Application Manual for Arms and Fixtures located on our website.

Contact an AIMCO Customer Service Associate for more details, 1-503-254-6600, or toll free 1-800-852-1368.



Mobile



Overhead Trolley Mount



Wall-Mount



Stationary Mount

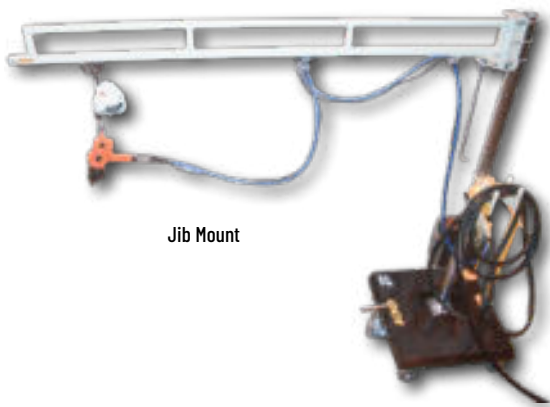

Jib Mount



Overhead Fixed Mount



# Workstation Components and Assemblies

## COMPONENTS

### TRACK

Steel with beige polyester finish. Use for vertical and horizontal workstation support.

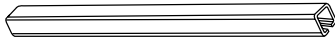

PART NUMBER	30# TRACK
AT3-3	3 ft track
AT3-4	4 ft track
AT3-6	6 ft track
AT3-9*	9 ft track

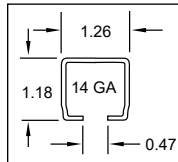

PART NUMBER	50# TRACK
AT5-3	3 ft track
AT5-4	4 ft track
AT5-6	6 ft track
AT5-9*	9 ft track
AT5-12*	12 ft track

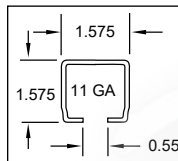

### TRACK NUT (ATN-3/5)

Zinc plated steel. Use to attach accessories to track, as end stops, or to isolate rolling accessories.

- ATN-3 for 30 lb. track
- ATN-5 for 50 lb. track



### END STOP (AES-3/5)

Zinc oxide finish. Use to prevent balancer trolley from "overtraveling" horizontal track.

- AES-3 for 30 lb. track
- AES-5 for 50 lb. track

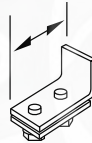

### MOUNTING PLATE (AMP-5)

Black polyester finish. Use as a base to mount vertical uprights.

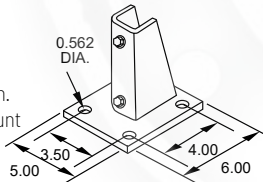

### END CAP (AEP-3/5)

Black molded vinyl. Use to cap track ends for a professional finish.

- AEP-3 for 30 lb. track
- AEP-5 for 50 lb. track



### ANGLE BRACKET (AB-3/5)

Black polyester finish. Use to mount horizontal track to vertical track.

- AB-3 for 30 lb. track
- AB-5 for 50 lb. track

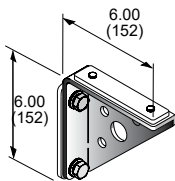

### JOINT HANGER BRACKET (AJH-3/5)

Black polyester finish. Use to couple and hang end-to-end track.

- AJH-3 for 30 lb. track
- AJH-5 for 50 lb. track

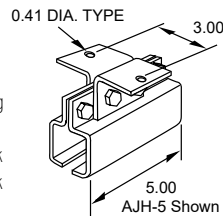

### BALANCER TROLLEY (ABT-3/5)

Black polyester finish. Use as moving support for tool balancers, hose, and cable. Quality ball bearing wheels for long life and smooth tracking.

- ABT-3 for 30 lb track (1.00 dia)
- ABT-5 for 50 lb track (1.25 dia)

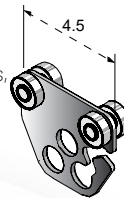

### HANGER BRACKET (AHB-3/5)

Black polyester finish. Use to suspend track at right angle.

- AHB-3 for 30 lb. track
- AHB-5 for 50 lb. track

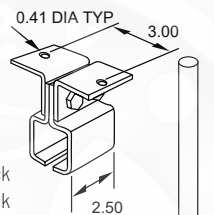

### VERTICAL COLUMN (AVC-5\*)

Beige polyester finish, 3" diameter x 9 ft upright steel column with welded base. Use as floor mount for extra stability with jibs or workstation components.



### HOSE/CABLE TROLLEY

Black polyester finish. Use for moving cable or hose festoon. Supports hose cable OD .60-.94.

- AIC5-2 for 50 lb. track

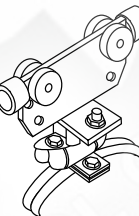

### U-BOLTS (AUB-5)

Zinc plated steel. Use to secure boom bracket, or any flat metal plate, to AVC-5 (sold individually).



### SUPPORT CLAMPS (ASC-3/5)

Black polyester finish. Use as additional support for track.

- ASC-3 for 30 lb. track
- ASC-5 for 50 lb. track

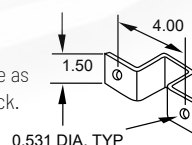

### TOOL CLIP (SH-5)

Steel clip with safety latch. Use for tool attachment and as replacement clip for lightweight tool balancers. Measures 2.37" long.



### 90° CONNECTOR FOR 3/8" HOSE (WSCH)

3/8" I.D. Brass. Use to provide stable transfer point from air line to tool. 90 degree connector attaches to ABT-5.

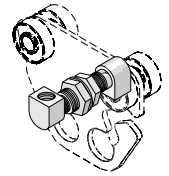

## WALL- AND FLOOR- MOUNTED JIBS

### 3 FT. SWINGING JIB (AW3S)

### 3 FT. FIXED JIB (AW3F)

### 3 FT. SWINGING JIB FOR CHANNEL MOUNT (AJS3\*\*)

Jibs are mounted to wall or beams to create free standing workstations. End stop, end cap, and balancer trolley included. Maximum weight: 30 lb.

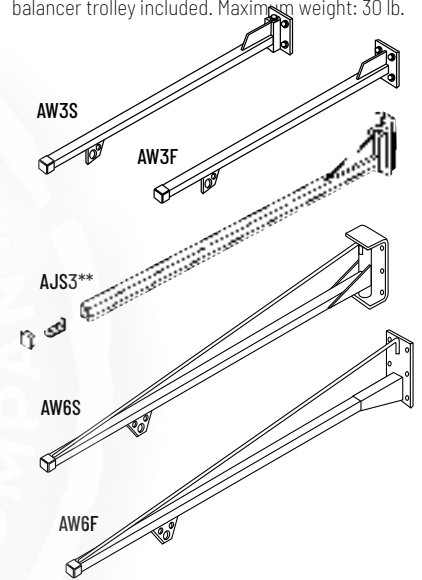

### 6 FT. SWINGING JIB (AW6S)

### 6 FT. FIXED JIB (AW6F)

Jibs can be wall mounted or attached to vertical column (AVC-5) to create a freestanding workstation. End stop, end caps, and balancer trolley are included. Maximum weight: 50 lb.

All complete assemblies are beige polyester finish and include balancer trolley, end caps, and end stops. Floor mounted assemblies are not able to ship via UPS.

**When choosing a workstation system, remember...**

Total weight capacities should include tool balancer, hose/cable, and tool/fixture. Units need to be supported vertically and horizontally every 6 ft.

\*\* Additional freight may apply

\*\* AJS3 Does not include balancer trolley

# Workstation Components and Assemblies

## FLOOR MOUNTED 3 FT. FIXED JIB\* (AW3FMF)

Maximum weight: 30 lb  
Column height: 6 ft

## FLOOR MOUNTED 6 FT. SWINGING JIB\* (AW6FMS\*)

## FLOOR MOUNTED 6 FT. FIXED JIB\* (AW6FMF\*)

Maximum weight: 50 lb  
Column height: 9 ft

\*Units include end stop,  
balancer trolley and intermediate carrier.

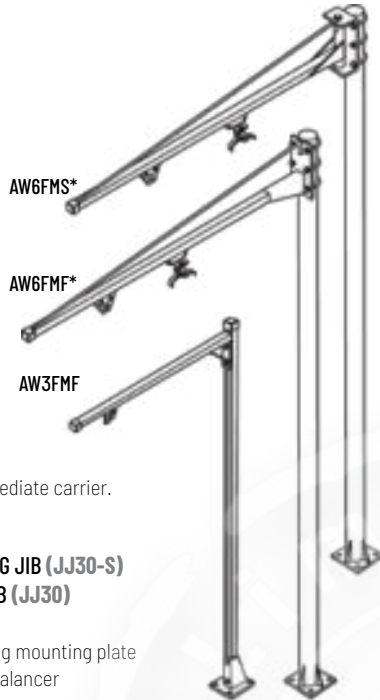

## BENCH MOUNTED SWINGING JIB (JJ30-S) BENCH MOUNTED FIXED JIB (JJ30)

Maximum weight: 30 lb  
Column height: 48" including mounting plate  
3 ft. swinging jib includes balancer  
trolley, end stop, and cap

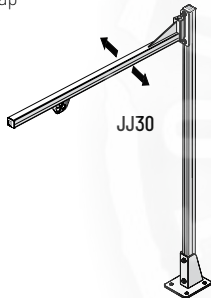

## AIMCO WORKSTATION KIT

### BENCH MOUNTED WORKSTATION WITH TORQUE ARM (JJ30-TA\*\*)

- 5 lb. maximum weight (RPA-3 included)
- 5' column height including mounting plate
- 38" jib length (swinging)
- 15 ft-lb torque rating
- 3/8" NPT inlet
- 1/4" NPT outlet
- Beige polyester finish
- 1/4" braided air hose
- 21" maximum vertical arm travel

\*\*Additional freight may apply  
\*\*For use with pneumatic tools only

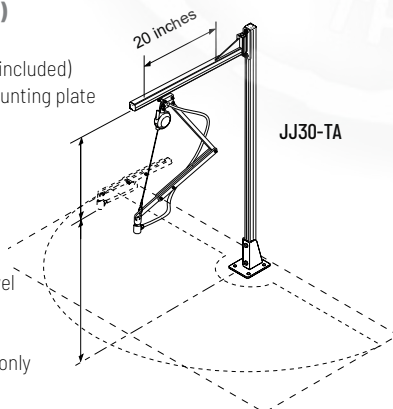

## CREATE A CUSTOM SUPPORT SYSTEM USING AIMCO'S QUALITY PRODUCTS

- Organize work area to create a safe, productive working environment
- Reduce risk of injury to assembler by providing support for heavy tools
- Protect valuable tools, fixtures, and monitoring devices from damage by suspending them out of the way

### AIMCO BASIC WORKSTATION KIT (ATW-50)



- 50 lb maximum weight capacity
- 48" uprights
- 36" extensions
- Table mounts included
- 6' tool rail with rolling trolley included
- All necessary hardware included

### TROLLEY MOUNTED TORQUE ARM WITH 3-LB RETRACTOR AND HOSE (FA-50-2\*)

Ergonomic arm absorbs torque reaction.  
Moves front to back along overhead jib.

### (TA-50-2)

Moves side to side on overhead track.

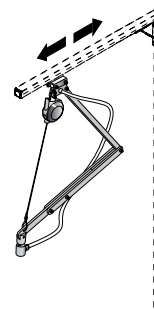

### TOOL BASKET (21226)

Mounts easily to any work area to  
hold pistol and angle style tools.

AIMCO can customize a workstation for you.

Contact an AIMCO Customer Service Associate 1-503-254-6600, or toll free 1-800-852-1368.

# Gravity-Defying Balancers

## TW SERIES BALANCERS



### TW-0 and TW-00

- Gravity defying / "true balance"
- No tension buildup to cause worker fatigue
- Easy external direct drive tensioning
- 360° upper swivel
- Safety cable provision
- Tool clip included



### TW-3 through TW-70

- Tapered drum allows "true balance" throughout cable travel
- Easy external direct drive tensioning
- Cast aluminum casing for durability
- Permanent lubrication
- 360° top swivel
- Enclosed spiral spring for added safety
- Safety chain provision (TW-3 through TW-15 models)
- Automatic safety lock plus manual drum lock (TW-22 through TW-70)

### TW Series Balancers

Model	Capacity		Anti-Gravity Capacity (LB)	Cable
	LB	KG		
TW-00	1.1 - 3.3	0.5 - 1.5	2.5 - 3.0	18" stranded steel cable 1/8 dia.
TW-0	1.1 - 3.3	0.5 - 1.5	2.5 - 3.0	3.3-ft stranded steel cable 1/8" dia..
TW-3	2.2 - 6.6	1.0 - 3.0	4.5 - 6.0	4.3-ft stranded steel cable 5/32" dia.
TW-5	5.5 - 11.0	2.5 - 5.0	8.0 - 10.5	4.3-ft stranded steel cable 5/32" dia.
TW-9	9.9 - 19.8	4.5 - 9.0	15.0 - 19.0	4.3-ft stranded steel cable 5/32" dia.
TW-15	19.8 - 33.0	9.0 - 15.0	26.0 - 32.5	4.3-ft stranded steel cable 5/32" dia.
TW-22	33.0 - 48.4	15 - 22	41.0 - 48.0	5-ft stranded steel cable 3/16" dia.
TW-30	48.4 - 66.0	22 - 30	58.0 - 65.5	5-ft stranded steel cable 3/16" dia.
TW-40	66.0 - 88.0	30 - 40	77.5 - 87.5	5-ft stranded steel cable 3/16" dia.
TW-50	88.0 - 110.0	40 - 50	100.0 - 109.5	5-ft stranded steel cable 3/16" dia.
TW-60	110.0 - 132.0	50 - 60	122.0 - 131.0	5-ft stranded steel cable 3/16" dia.
TW-70	132.0 - 154.0	60 - 70	144.0 - 153.0	5-ft stranded steel cable 3/16" dia.

## ASB SERIES BALANCERS

- Built-in Safety Features: The cable, drum, and enclosed spring are fully visible without opening the unit for easy and convenient safety checks. The sturdy spiral spring is enclosed for greater control and safety
- Ergonomic Spring Release: The automatic safety lock provides extra control
- Extended Cable Length: Stainless steel cables allow for extended reach on applications
- Enhanced Gear Mechanism: Allows for more exact adjustment of tension
- No Recoil and Low Resistance: Tapered drum style provides gravity defying tool positioning and low travel



ASB-0C Gravity Defying and Hand Adjustable Balancer



ASB-3C  
ASB-5C

### ASB Series Balancers

Model	Capacity		Stroke		Weight	
	lb	kg	in	cm	lb	kg
ASB-0C	1.1 - 3.3 lb	0.5 - 1.5 kg	51.1 in	130 cm	1.5 lb	0.7 kg
ASB-3C	3.3 - 6.6 lb	1.5 - 3 kg	86.4 in	220 cm	3.0 lb	1.4 kg
ASB-5C	5.5 - 11 lb	2.5 - 5 kg	86.4 in	220 cm	3.4 lb	1.5 kg

# Line Reel Balancers / Retractors

## LINE REEL BALANCERS

### LR Series

- Designed for light duty applications with small pneumatic tools
- Integrating air hose and support cable keep work areas clean
- Adjustable ball stop for optional positioning
- 1/4" I.D. polyvinyl hose with 1/4" NPT inlet
- 360° upper swivel
- Maximum 142 PSI



### LR Series Line Reel Balancers

Model	Hose Length		Capacity	
LR-09B-90	35.5 in	90 cm	3 lb	1.5 kg
LR-09B-200	78.3 in	199 cm	3 lb	1.5 kg

## RETRACTORS

### RPA Series

- No tools needed to set tension
- 5 ft nylon coated steel cable
- Reinforced hanging bracket includes safety cable provision
- Adjustable cable stop
- Three (3) models support weight 0.5 - 5 lb
- Tool clip included

### RMA-L Series

- Steel housing with polyester finish
- Reinforced hanging bracket includes safety cable provision
- 8 ft of 3/32" diameter coated steel cable
- Permanently lubricated
- Tool clip included
- External tension adjustment
- Ratchet cable lock



### RPA / RMA-L Series Retractors

Model	Capacity	
RPA-1	0.5 - 1.5 lb	0.2 - 0.7 kg
RPA-2	1.5 - 3.0 lb	0.7 - 1.4 kg
RPA-3	3.0 - 5.0 lb	1.4 - 2.3 kg
RMA-7L	5 - 10 lb*	2.3 - 4.8 kg*
RMA-15L	10 - 15 lb*	4.5 - 6.8 kg*
RMA-20L	15 - 23 lb*	6.8 - 10.4 kg*

\* With ratchet lock

# Air Preparation Units

## AFRL STACKING FILTER/REGULATORS

Stacking filter/regulator combinations provide air filtration and precise regulation in a single unit for easy mounting and installation.

### FEATURES AND BENEFITS

- All models include L-mount bracket, gauge, and metal bowl shields
- Polycarbonate filter and lubricator bowls (metal bowls standard on AFRL-8)
- 25-micron filter included on all models
- Regulating range: 7 - 125 PSI
- Custom order upgrade items include metal bowl, 5 micron filter, semi-automatic filter drain, and reduced PSI range regulator. Contact an AIMCO Customer Service Associate for more information, 1-503-254-6600, or toll free 1-800-852-1368
- **Maximum allowable Input Pressure not to exceed 120 PSI**



AFRL-2-C  
AFRL-3-C

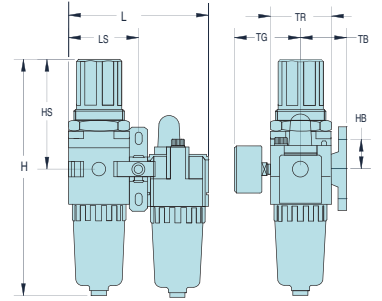

AFRL-3  
AFRL-4  
AFRL-8

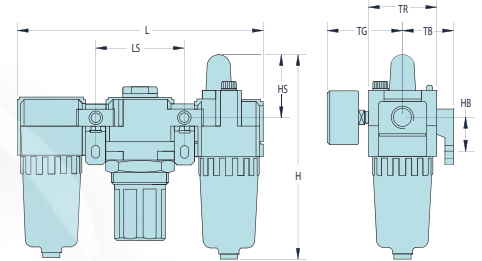

28178  
HT Air Tool/AFRL  
Carrying Kit



AFRL-4HTA  
Standalone Unit

### AFRL Stacking Filter/Regulators

Model	Port	Gauge Port	Flow Rate CFM	Flow Rate L/MIN	Bowl Shield	H IN/MM	HB IN/MM	HS IN/MM	L IN/MM	LS IN/MM	TB IN/MM	TG IN/MM	TR IN/MM
AFRL-2	1/4"	1/8"	70	2,000	yes	6.16 (156.5)	1.39 (35.3)	1.50 (38.1)	7.13 (181.1)	2.52 (64.0)	1.61 (41.0)	2.39 (60.7)	2.09 (53.1)
AFRL-2-C	1/4"	1/8"	60	1,700	yes	8.31 (211.1)	1.38 (35.1)	3.64 (92.5)	4.61 (117.1)	2.30 (58.4)	1.61 (40.9)	2.39 (60.7)	2.09 (53.1)
AFRL-3	3/8"	1/4"	140	4,000	yes	7.54 (191.5)	1.57 (40.0)	1.61 (40.9)	9.37 (238.0)	3.31 (84.1)	1.97 (50.0)	2.58 (65.5)	2.76 (70.1)
AFRL-3-C	3/8"	1/4"	105	3,000	yes	10.31 (261.9)	1.57 (39.9)	4.41 (112.0)	6.06 (153.9)	3.03 (77.0)	1.97 (50.0)	2.58 (65.5)	2.76 (70.1)
AFRL-4	1/2"	1/4"	140	4,000	yes	7.54 (191.5)	1.57 (40.0)	1.61 (40.9)	9.37 (238.0)	3.31 (84.1)	1.97 (50.0)	2.58 (65.5)	2.76 (70.1)
AFRL-8	1"	1/4"	180	5,000	yes	10.69 (271.5)	1.97 (50.0)	1.89 (48.0)	11.81 (300.0)	4.13 (104.9)	2.75 (69.9)	2.97 (75.4)	3.54 (89.9)

### Air Preparation Units: Basic Functions

The diagram illustrates the flow of air from a pressure vessel through three stages: a filter, a regulator, and a lubricator. The filter removes contaminants, the regulator regulates pressure, and the lubricator adds oil. The final output is clean, regulated, and lubricated compressed air for tools.

The supply of clean, dry air is essential to the operation of pneumatic powered tools. Use only clean filtered air for longer tool life. Provide proper airflow (CFM) and regulate air pressure (PSI) for optimum performance.

**To determine unit size for application, you need to know:**

- Total air flow (CFM) required for application
- Size of incoming air line and size of air line required by tool
- Air supply pressure (PSI)
- Allowable pressure drop
- Does the application require lubrication?
- Does the overall system have the required capacity?

# Air Line

## Polyurethane Hose



- Durable Polyurethane is chemical resistant and lightweight, and provides excellent recoil memory and maximum flexibility
- Available in transparent hose color (opaque also available)
- Assemblies for coiled hose include reusable swivel fitting. Straight hose available with or without fittings
- Working temperature:  $-104^{\circ}\text{F}$  to  $175^{\circ}\text{F}$

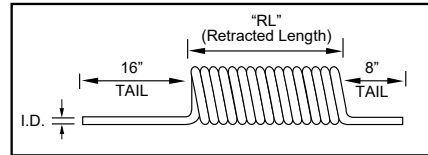

## Single Air Hose Assemblies (Coiled)

Model	Description (O.D. x I.D. x Length)	Retracted Length	Working Pressure	Npt Fittings
ASH-250C-10MSZ	3/8" x 1/4" x 10'	7"	100 psi	1/4"
ASH-250C-15MSZ	3/8" x 1/4" x 15'	9-1/2"	100 psi	1/4"
ASH-250C-25MSZ	3/8" x 1/4" x 25'	15-1/2"	100 psi	1/4"
ASH-375C-15MSZ	9/16" x 3/8" x 15'	10"	100 psi	3/8"
ASH-375C-25MSZ	9/16" x 3/8" x 25'	14"	100 psi	3/8"
ASH-500C-15MSZ	3/4" x 1/2" x 15'	13"	100 psi	1/2"
ASH-500C-25MSZ	3/4" x 1/2" x 25'	23"	100 psi	1/2"

Custom length coil assemblies and special colors available in minimum order quantities. Contact an AIMCO Customer Service Associate, 1-503-254-6600, or toll free 1-800-852-1368.



### Straight Air Hose (Sold Per Foot)

Model	Description
ASH-375Z	3/8" I.D.
ASH-500Z	1/2" I.D.

Contact an AIMCO Customer Service Associate about full reel pricing, 1-503-254-6600, or toll free 1-800-852-1368.

## Rubber Hose



- Designed for use in a wide range of industrial, construction, and agricultural applications
- Constructed of high grade, reinforced EPDM synthetic rubber
- Working temperature:  $-40^{\circ}\text{F}$  to  $190^{\circ}\text{F}$

### Single Air Hose (Rubber)

I.D.	O.D.	Length	Working Pressure	Weight
3/16"	0.44"	10 ft	200 psi	0.8 lb
1/4"	0.5"	10 ft	200 psi	0.9 lb
5/16"	0.58"	10 ft	200 psi	1.2 lb
3/8"	0.67"	10 ft	200 psi	1.5 lb
1/2"	0.81"	10 ft	200 psi	2.0 lb
5/8"	0.97"	10 ft	200 psi	2.7 lb
3/4"	1.12"	10 ft	200 psi	3.4 lb

Custom lengths available. Contact an AIMCO Customer Service Associate for more details, 1-503-254-6600, or toll free 1-800-852-1368.

## Helpful Hints For Air Hose Use

- Use recommended I.D. air hose and fittings
- Replace air hose regularly to help maintain clean air
- A clear hose allows you to see water or dirt accumulation in hose
- Use correct length of hose to reduce air loss and pressure drop
- Use locking quick-disconnect couplers for additional safety

# Air Line Accessories

## BRASS QUICK COUPLERS

Manual ball couplers designed for use with ergonomic twist plugs. Brass with nitrile seals, rated to 300 PSI, from -40° to +250° F.



Model	Description
B23	1/4" NPT F x 1/4" QC Brass Coupler
B23E	1/4" NPT F x 3/8" QC Brass Coupler
B25	3/8" NPT F x 3/8" QC Brass Coupler

## IN-LINE MINI REGULATORS

Easily adjust airflow with the turn of a dial.



Model	Capacity
932-100-0	1/8" NPT
932-110-0A	1/4" NPT

## MINI AIR GAUGE SWIVEL JOINT KITS

- Bi-directional 360° rotation
- Keeps air hose straight and untwisted
- Decreases operator fatigue



Model	Inlet	Weight	Max Psi	Tool CFM
7021AG	1/4" NPT	3 oz	Up to 125	25
7041AG	3/8" NPT	3 oz	Up to 125	50



7021AG

## SWIVEL AIR FITTINGS

For use with most portable air tools, including grinders, drills, screwdrivers, buffers, sanders, staple guns, and more. Rotates 360° for awkward angles.

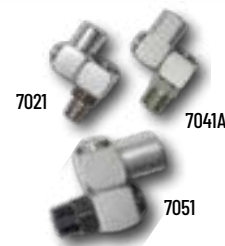

Model	Inlet	Weight	Max PSI	Tool CFM
7021	1/4" NPT	3 oz	Up to 125	25
7041A	3/8" NPT	11 oz	Up to 125	50
7051	1/2" NPT	7 oz	Up to 125	60

## AIR LINE FITTINGS

Model	Capacity
250-RZ	1/4" NPT Rigid Fitting
250-SZ	1/4" NPT Swivel Fitting
375-RZ	3/8" NPT Rigid Fitting
375-SZ	3/8" NPT Swivel Fitting
500-SZ	1/2" NPT Swivel Fitting



## BRASS ADAPTERS AND BUSHINGS

Pipe fittings for use as medium and low pressure connectors. Meets functional requirements of SAE J530, SAE J531, ASME and ASA. Rated 1,000 PSI from -65° to +250° F.



Model	Description
222P-6-4	3/8" NPT F x 1/4" NPT M Adapter
222P-8-6	1/2" NPT F x 3/8" NPT M Adapter
222P-12-8	3/4" NPT F x 1/2" NPT M Adapter
209P-6-4	1/4" NPT F x 3/8" NPT M Bushing
209P-8-6	3/8" NPT F x 1/2" NPT M Bushing

## ERGONOMIC TWIST PLUGS

These unique, ergonomically designed hose fittings provide 360° rotation and 35° angled rotation in any direction.

- Two rotation points prevent kinking of air hose
- Design ensures full air pressure flow
- Rotating joint comes with polyurethane dust cover
- Heavy duty construction



TS-30NP-2NPT



TS-20NP-2NPT



TS-20US-2NPT



TS-30US-3NPT

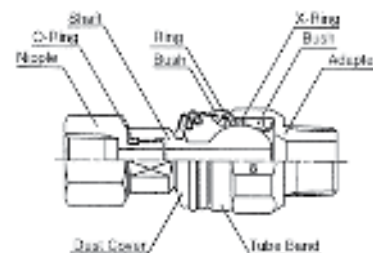

Model	Description
TS-30NP-2NPT	3/8" NPT Female x 1/4" NPT Male
TS-20NP-2NPT	1/4" NPT Female x 1/4" NPT Male
TS-20US-2NPT	1/4" US Plug x 1/4" NPT Male
TS-30US-3NPT	3/8" US Plug x 3/8" NPT Male

# Standard Fastener Tools

## STANDARD FASTENER TOOLS

### Connect your tool to the application with Bits, Sockets, and Nutsetters from AIMCO

AIMCO has assembled a complete package of commonly used screwdriver bits and nutsetters. Our goal is to supply you with the highest quality bits and nutsetters for your fastener needs. Whether you're in electronics, aerospace, automotive, or general industry, AIMCO has the bits and nutsetters to fit your needs.

### MAG-O-NETS®: A Revolutionary Way to Convert Standard Bits to Magnetic Bits

#### FEATURES AND BENEFITS

- Easy, cost effective alternative to traditional magnetic bit holder and insert bit combination
- Improves torque transfer by eliminating "wobble effect"
- Easily adjust magnetic attraction by moving Mag-O-Net collar closer to or further from fastener
- Fits virtually any standard screwdriver bit
- Reusable and interchangeable – once a bit is worn out, simply remove your Mag-O-Net and slide it onto the next bit
- Lifetime guarantee on magnetic attraction



\*U.S. Patent 5861789

Part No	Inner Diameter (Id)	Outer Diameter (OD)	L MM
AM1/4Z	7 mm	19 mm	10
AM5Z	6 mm	17,5 mm	10
AM3/16Z	3/16 in	17,5 mm	10
AM5/16Z	5/16 in	20 mm	10



## MARKER SOCKETS

Marker Sockets paint the bolt head at the same time the torque is checked. Sockets are designed to your specification.

- Unit consists of a marker socket, an ink cartridge, a spring, and the cartridge cap
- Cartridge can be inserted/taken off easily for ink management
- Easily replaceable paint point
- Can be used with either oil-based or water-based inks
- When ordering, provide dimensions shown. To order, contact an AIMCO Customer Service Associate 1-503-254-6600, or toll free 1-800-852-1368



Bolt



Nut



Recessed bolt

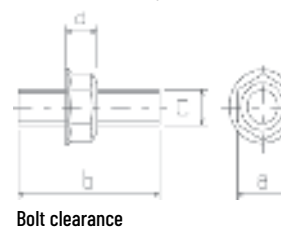
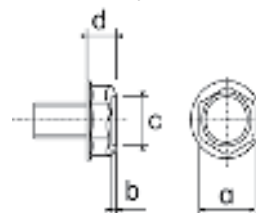

Bolt clearance

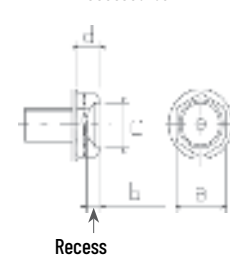

Recess



# Standard Fastener Tools

## IMPACT SOCKETS

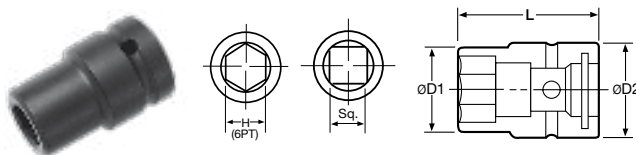

	Part No	Hex	D1 MM	D1 IN	D2 MM	D2 IN	L MM	L IN
SAE	<b>3/8" Square Drive</b>							
	A31/4	1/4"	10	0.39	19	0.75	34	1.34
	A35/16	5/16"	12	0.47	19	0.75	34	1.34
	A33/8	3/8"	15	0.59	19	0.75	34	1.34
Metric	A306	6 mm	10	0.39	19	0.75	34	1.34
	A307	7 mm	13	0.49	20	0.79	32	1.26
	A308	8 mm	14	0.55	20	0.79	32	1.26
<b>3/8" Square Drive, Deep</b>								
	A307-2	7 mm	13	0.49	20	0.79	50	1.97
	A307-2.75	7 mm	13	0.49	20	0.79	70	2.76
	A308-2	8 mm	14	0.55	20	0.79	50	1.97
<b>3/8" Square Drive, Magnetic</b>								
SAE	A31/4MP	1/4"	10	0.39	19	0.75	34	1.34
	A35/16MP	5/16"	12	0.47	19	0.75	34	1.34
	A33/8MP	3/8"	15	0.59	19	0.75	34	1.34
Metric	A308MP	8 mm	14	0.55	20	0.79	32	1.26
	A310MP	10 mm	17	0.65	20	0.79	32	1.26
	A311MP	11 mm	17	0.65	19	0.75	34	1.34
<b>1/2" Square Drive</b>								
SAE	A43/8	3/8"	16	0.63	25	0.98	38	1.50
	A47/16	7/16"	18	0.69	25	0.98	38	1.50
	A41/2	1/2"	19	0.75	25	0.98	50	1.97
Metric	A408	8 mm	16	0.61	25	0.98	40	1.58
	A409	9 mm	16	0.63	25	0.98	40	1.58
	A410	10 mm	18	0.69	25	0.98	40	1.58
<b>1/2" Square Drive, Deep</b>								
SAE	A43/8-3.25	3/8"	17	0.67	25	0.98	82	3.23
	A47/16-3.25	7/16"	19	0.73	25	0.98	82	3.23
	A41/2-3.25	1/2"	22	0.85	25	0.98	82	3.23

	Part No	Hex	D1 MM	D1 IN	D2 MM	D2 IN	L MM	L IN
Metric	A410-2	10 mm	18	0.69	25	0.98	50	1.97
	A410-3	10 mm	18	0.69	25	0.98	75	2.95
	A410-3.25	10 mm	17	0.67	25	0.98	82	3.23
	A411-3.25	11 mm	19	0.73	25	0.98	82	3.23
<b>1/2" Square Drive, Magnetic</b>								
	A408MP	8 mm	16	0.61	25	0.98	40	1.58
	A410MP	10 mm	18	0.69	25	0.98	40	1.58
	A412MP	12 mm	21	0.81	25	0.98	40	1.58
<b>3/4" Square Drive</b>								
SAE	A611/16	11/16"	30	1.18	44	1.73	50	1.97
	A63/4	3/4"	32	1.26	44	1.73	50	1.97
	A613/16	13/16"	35	1.38	44	1.73	50	1.97
Metric	A614	14 mm	24	0.95	38	1.50	55	2.17
	A616	16 mm	27	1.06	44	1.73	50	1.97
	A617	17 mm	30	1.18	38	1.50	55	2.17
<b>3/4" Square Drive, Deep</b>								
SAE	A611/16-4	11/16"	31	1.22	44	1.73	100	3.94
	A63/4-4	3/4"	33	1.30	44	1.73	100	3.94
	A613/16-4	13/16"	36	1.42	44	1.73	100	3.94
Metric	A617-4	17 mm	31	1.22	44	1.73	100	3.94
	A618-4	18 mm	32	1.26	44	1.73	100	3.94
	A619-4	19 mm	33	1.30	38	1.50	100	3.94
<b>1" Square Drive</b>								
SAE	A87/8	7/8"	37	1.46	54	2.13	59	2.32
	A815/16	15/16"	38	1.50	54	2.13	59	2.32
	A81	1"	41	1.61	54	2.13	59	2.32
Metric	A817	17 mm	31	1.22	50	1.97	63	2.48
	A819	19 mm	33	1.30	50	1.97	63	2.48
	A821	21 mm	37	1.46	50	1.97	63	2.48

Additional types and sizes of fastener tools, as well as custom parts, are available upon request. Contact an AIMCO Customer Service Associate at 1-503-254-6600, or toll free 1-800-852-1368.

## ANTI-MARRING SOCKETS

AIMCO's anti-marring sockets have a protective resin cover that spins freely, preventing damage to application surfaces, and protecting fingers.



CV Series



CVF Series



CVF Series with Bit Attachment



# Standard Fastener Tools

## UNIVERSAL SOCKETS

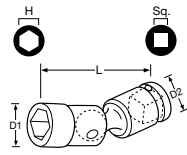

Part No	Hex	D1 MM	D1 IN	D2 MM	D2 IN	L MM	L IN
<b>3/8" Square Drive</b>							
A310U	10 mm	16	0.63	20	0.79	55	2.17
A311U	11 mm	16	0.63	20	0.79	60	2.36
<b>1/2" Square Drive</b>							
A412U	12 mm	20.5	0.81	25	0.98	70	2.76
A413U	13 mm	19	0.75	24	0.95	70	2.76

## QUICK CHANGE CHUCKS

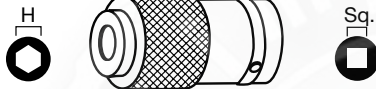

Part No	Sq Drive	Hex	D1 MM	D1 IN	L MM	L IN
ADC-2S	1/4"	1/4"	19	0.75	38	1.50
ADC-3S	3/8"	1/4"	20	0.79	42	1.65
ADC-4S	1/2"	1/4"	19	0.75	46	1.81
ADC-3SH7/16Z	3/8"	7/16"	25	0.98	46	1.81
ADC-4SH7/16Z	1/2"	7/16"	33	1.30	55	2.17

## ALLEN SOCKETS

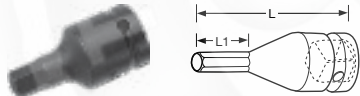

Part No	Hex	L1 MM	L1 IN	L MM	L IN
<b>3/8" Square Drive</b>					
A31/4C	1/4"	10	0.39	42	1.65
A304C	4 mm	10	0.39	42	1.65
<b>1/2" Square Drive</b>					
A41/4C	1/4"	25	0.98	50	1.97
A405C	5 mm	25	0.98	50	1.97

## EXTENSIONS

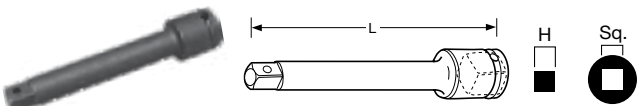

Part No	Sq Drive	Hex	L MM	L IN	D MM	D IN
A375E	3/8"	3/8"	75	2.95	20	0.79
A405E	1/2"	1/2"	51	2.01	30	1.18
A610E	3/4"	3/4"	100	3.94	44	1.73
A810E	1"	1"	102	4.02	54	2.13
A1220E	1-1/4"	1-1/4"	200	7.87	60	2.36
A1418E	1-1/2"	1-1/2"	178	7.01	84	3.31
A2426E	2-1/2"	2-1/2"	264	10.39	137	5.39

## NUTSETTERS

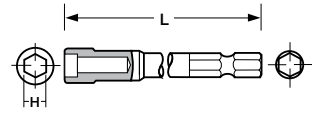

PART NO	HEX	L MM	L IN
A3B1/4-2	1/4"	50	1.97
A3B1/4-2.5	1/4"	63	2.50
A3B5/16-2	5/16"	50	1.97
A3B5/16-2.5	5/16"	63	2.50
A3B3/8-2	3/8"	50	1.97
A3B3/8-2.5	3/8"	63	2.50
A3B05-2.75	5 mm	70	2.76
A3B55-1.2	5.5 mm	30	1.18
A3B55-2.75	5.5 mm	70	2.76
A3B55-4	5.5 mm	100	3.94
A3B06-2.75	6 mm	70	2.76
A3B07-1.2	7 mm	30	1.18
A3B07-2	7 mm	50	1.97
A3B07-2.75	7 mm	70	2.76
A3B07-4	7 mm	100	3.94
A3B08-1.2	8 mm	30	1.18
A3B08-2	8 mm	50	1.97
A3B08-2.75	8 mm	70	2.76
A3B08-4	8 mm	100	3.94
A3B08-6	8 mm	150	5.91
A3B08-8	8 mm	200	7.87
A3B09-2.75	9 mm	70	2.76
A3B09-4	9 mm	100	3.94
A3B10-1.2	10 mm	30	1.18
A3B10-2	10 mm	50	1.97
A3B10-2.75	10 mm	70	2.76
A3B11-2.75	11 mm	70	2.76
A3B12-1.2	12 mm	30	1.18
A3B13-2.75	13 mm	70	2.76
A3B14-2.75	14 mm	70	2.76
A3B16-2.75	16 mm	70	2.76
A3B17-2.75	17 mm	70	2.76

## SOCKET ADAPTERS



Part No	Female Sq. Drive	Male Sq. Drive	D MM	D IN	L MM	L IN
A302A	3/8"	1/4"	22	0.87	35	1.38
A403A	1/2"	3/8"	25	0.98	37	1.46
A504A	5/8"	1/2"	35	1.38	47	1.46
A604A	3/4"	1/2"	38	1.50	53	2.09
A806A	1"	3/4"	50	1.97	70	2.76
A128A	1-1/4"	1"	60	2.36	76	2.99
A#508A	Spline #5	1"	60	2.36	90	3.54

Additional types and sizes of fastener tools, as well as custom parts, are available upon request. Contact an AIMCO Customer Service Associate at 1-503-254-6600, or toll free 1-800-852-1368.

# Standard Fastener Tools

## PHILLIPS POWER BITS

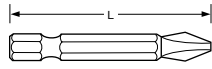

Part No	Point Size	L MM	L IN
A3S0-2	0	50	1.97
A3S1-2	1	50	1.97
A3S1-2.75	1	70	2.76
A3S1-3	1	75	2.95
A3S1-3.5	1	90	3.54
A3S1-4	1	100	3.94
A3S1-6	1	150	5.91
A3S2-1.2	2	30	1.18
A3S2-1.6	2	40	1.57
A3S3-2	3	50	1.97
A3S3-2.75	3	70	2.76

### Double-Ended

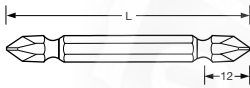

A3W1-3	1	75	2.94
A3W2-2	2	50	1.97
A3W2-3	2	75	2.94
A3W2-4	2	100	3.94
A3W2-6	2	150	5.91
A3W2-8	2	200	7.87
A3W2-10	2	250	9.84
A3W2-12	2	300	11.81
A3W3-2	3	50	1.97
A3W3-3	3	75	2.94
A3W3-4	3	100	3.94
A3W3-6	3	150	5.91
A3W3-8	3	200	7.87

## TORX POWER BITS

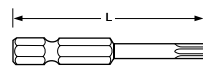

Part No	Torx Size	L MM	L IN
A3T6-2	T6	50	1.97
A3T7-2	T7	50	1.97
A3T7-2.75	T7	70	2.76
A3T7-3.5	T7	90	3.54
A3T7-6	T7	150	5.91
A3T8-2	T8	50	1.97
A3T9-2.75	T9	70	2.76

## BIT HOLDERS

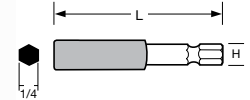

Part No	L MM	L IN
<b>1/4" Hex, Magnetic</b>		
A3BHM-3	75	2.94
A3BHM-4	100	3.94
A3BHM-6	150	5.91
A3BHM-8	200	7.87
A3BHM-10	250	9.84

## Bit and Nutsetter Part Number Nomenclature

### Precedes Part Number

<b>BITS</b>	A7 = 7/16 Power Drive
A3S = Phillips® Power Drive	AS = Electric Type Phillips®
A3W = Double Ended Phillips®	AM = Electric Type Slotted
A38S = Phillips® Insert	ATW = Electric Type Tri-Wing®
A39S = Phillips® Insert Reduced Nose	AT = Electric Hios Type Torx®
A3M = Slotted Power Drive	A26S = Electric Driver Phillips®
A38M = Slotted Insert	A26M = Electric Driver Slotted
A3MT = Slotted Power Drive Reduced Nose	A26C = Electric Driver Allen Socket Head
A3C = Allen Socket Head Power Drive	A3BHM = Insert Bit Holder (Magnetic Type)
A38C = Allen Socket Head Insert	A3BHD = Insert Bit Holder (Non Magnetic)
A3R = Square Recess Power Drive	
A3RT = Square Recess Turned Down (Power)	
A38R = Square Recess Insert	<b>NUTSETTERS</b>
A3T = Torx® Power Drive	A3B = Nutsetter
A38T = Torx® Insert	A3BMP = Magnetic (MP) Pressed Type
A3TS = Torq-Set® Power Drive	A3BMS = Magnetic (MS) Spring Loaded
A38TS = Torq-Set® Insert	A3BMT = Magnetic (MT) Tube Type
A3TA = Triangle Power Drive	A3BU = Universal Nutsetter
A3TW = Tri-Wing® Power Drive	
A38TW = Tri-Wing® Insert	<b>MAG-0-NETS</b>
	AM = AIMCO Mag-0-Net®

### Contained within Part Number

<b>BITS</b>	
PZ = Pozidriv®	
PZACR = Pozidriv® ACR®	
SDV = Supadriv®	
TR = Torx® Tamper Resistant	
ACRI = ACR® Installation	
ACR = ACR® Remove	
ACRB = ACR® 4x4 Both Install and Remove	
E4 = Electric 4 mm diameter	
E5 = Electric 5 mm diameter	
RS = Reduced Shank	

Additional types and sizes of fastener tools, as well as custom parts, are available upon request. Contact an AIMCO Customer Service Associate at 1-503-254-6600, or toll free 1-800-852-1368.

# Ergo-Drive Series

## ERGO-DRIVE® SOCKETS PROTECT...



### ...YOUR INVESTMENT!

Pulse tools are an investment and the anvil is the most expensive single part of any pulse tool. ERGO-DRIVE sockets decrease vibration and wear on this critical component.

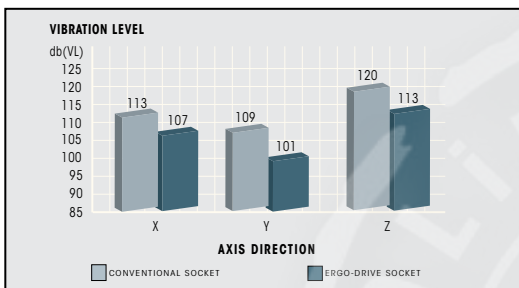
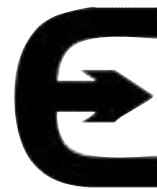

### ...YOUR ASSEMBLERS!

ERGO-DRIVE sockets cause significantly less vibration during fastening than conventional sockets. This allows your assemblers to do their jobs without the worry of vibration related injuries.

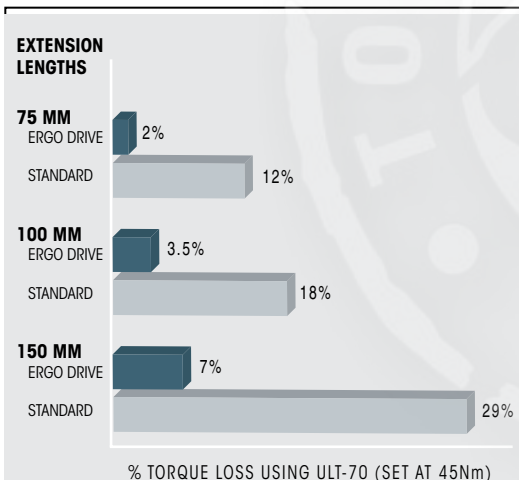

### ...YOUR PRODUCTS!

By reducing run-out and vibration, ERGO-DRIVE sockets allow the most repeatable, accurate rundowns to take place, ensuring excellent product quality.



## ERGO-DRIVE VS. STANDARD

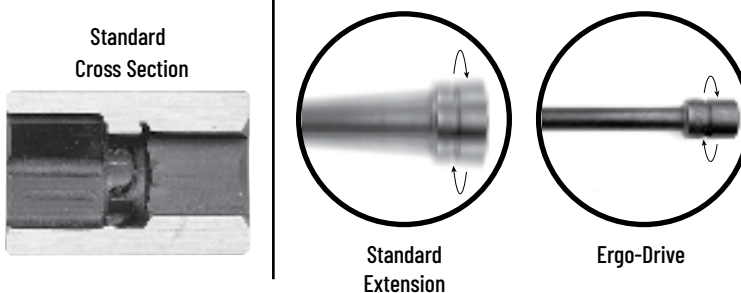
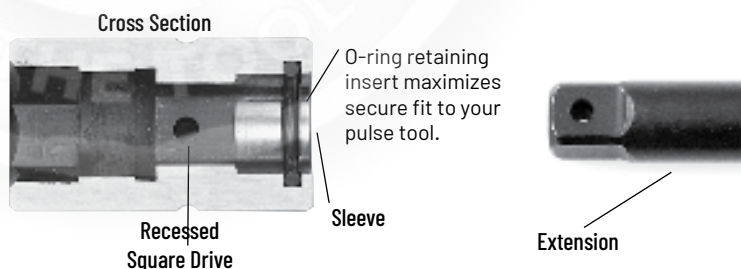

# Ergo-Drive Fastener Tools

## ERGO-DRIVE SOCKETS

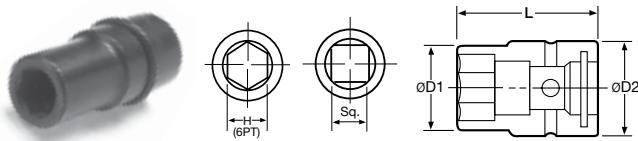

Part No	Hex	D1 MM	D1 IN	D2 MM	D2 IN	L MM	L IN
---------	-----	----------	----------	----------	----------	---------	---------

3/8" Square Drive							
A31/4EDS	1/4"	10	0.39	19	0.75	44	1.73
A31/2EDS	1/2"	20	0.77	22	0.87	44	1.73
A306EDS	6 mm	10	0.39	19	0.75	44	1.73
A308EDS	8 mm	14	0.55	20	0.79	42	1.65
A310EDS	10 mm	17	0.65	20	0.79	42	1.65
A312EDS	12 mm	20	0.79	20	0.79	42	1.65
A314EDS	14 mm	22	0.87	20	0.79	42	1.65
A316EDS	16 mm	25	0.98	20	0.79	45	1.77
A318EDS	18 mm	27	1.06	20	0.79	45	1.77

1/2" Square Drive							
A41/2EDS	1/2"	19	0.75	25	0.98	50	1.97
A413EDS	13 mm	22	0.85	25	0.98	52	2.05
A414EDS	14 mm	23	0.89	25	0.98	52	2.05
A415EDS	15 mm	24	0.93	25	0.98	52	2.05
A416EDS	16 mm	25	0.98	25	0.98	52	2.05
A417EDS	17 mm	28	1.10	28	1.10	54	2.13
A418EDS	18 mm	29	1.14	28	1.10	54	2.13
A419EDS	19 mm	30	1.18	28	1.10	54	2.13

3/4" Square Drive							
A61/8EDS	1-1/8"	44	1.73	44	1.73	64	2.52
A61/4EDS	1-1/4"	49	1.91	44	1.73	66	2.60
A61/2EDS	1-1/2"	57	2.24	44	1.73	68	2.68
A618EDS	18 mm	31	1.22	44	1.73	60	2.36
A624EDS	24 mm	40	1.52	40	1.73	65	2.36

1" Square Drive							
A81/16EDS	15/16"	38	1.50	54	2.13	69	2.72
A8100EDS	100 mm	136	5.35	76	2.99	120	4.72

## ERGO-DRIVE EXTENSIONS

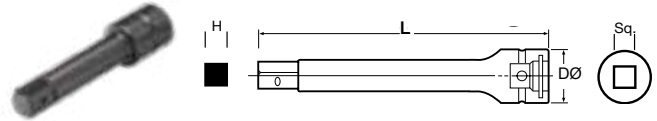

Part No	Sq Drive	H	L MM	L IN	D MM	D IN
---------	-------------	---	---------	---------	---------	---------

3/8" Square Drive						
A352EDE	3/8"	3/8"	52	2.05	20	0.79
A3100EDE	3/8"	3/8"	100	3.94	20	0.79
A375EDE	3/8"	3/8"	75	2.95	20	0.79
A3150EDE	3/8"	3/8"	150	5.91	20	0.79
A3190EDE	3/8"	3/8"	190	7.48	20	0.79
A3254EDE	3/8"	3/8"	254	10.00	20	0.79
A3300EDE	3/8"	3/8"	300	11.81	20	0.79
A3320EDE	3/8"	3/8"	320	12.60	20	0.79

1/2" Square Drive						
A464EDE	1/2"	1/2"	64	2.52	28	1.10
A476EDE	1/2"	1/2"	76	2.99	28	1.10
A4125EDE	1/2"	1/2"	125	4.92	28	1.10
A4204EDE	1/2"	1/2"	204	8.03	28	1.10
A4254EDE	1/2"	1/2"	254	10.00	28	1.10
A4355EDE	1/2"	1/2"	355	13.98	28	1.10

3/4" Square Drive						
A676EDE	3/4"	3/4"	76	2.99	40	1.58
A6100EDE	3/4"	3/4"	100	3.94	40	1.58
A6150EDE	3/4"	3/4"	150	5.91	40	1.58
A6200EDE	3/4"	3/4"	200	7.87	40	1.58

1" Square Drive						
A8150EDE	1"	1"	150	5.91	54	2.13
A8200EDE	1"	1"	200	7.87	54	2.13

## ERGO-DRIVE QUICK CHANGE CHUCKS

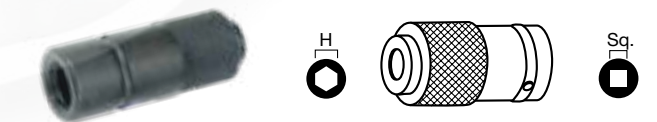

Part No	Square Drive	Hex
---------	--------------	-----

3/8" Square Drive		
ADC-3SEDSQ	3/8"	1/4"
ADC-3SEDSQH7/16	3/8"	7/16"

1/2" Square Drive		
ADC-4SEDSQ	1/2"	1/4"
ADC-4SEDSQH7/16	1/2"	7/16"

Additional types and sizes of fastener tools, as well as custom parts, are available upon request. Contact an AIMCO Customer Service Associate at 1-503-254-6600, or toll free 1-800-852-1368.

# Custom Bits, Sockets, and Extensions

## CUSTOM BITS, SOCKETS, AND EXTENSIONS FOR THE POWER TOOL USER

AIMCO can provide specials for virtually any application. From design to delivery, AIMCO's quick response ensures high quality, tight tolerance specials.

Specials are available in every style including:

- Deep Socket
- Extended Socket
- Universal
- Allen Head
- Torx Head
- Socket Adapter
- Nut Runner Socket
- Nut Runner Joint
- Nutsetter
- Magnetic Nutsetter
- Universal Nutsetter
- Screwdriver Bits



Sample request forms are shown. Your detailed requirements will allow AIMCO to quickly respond with custom solutions for your fastening applications.



### MAGNETIC STYLES:

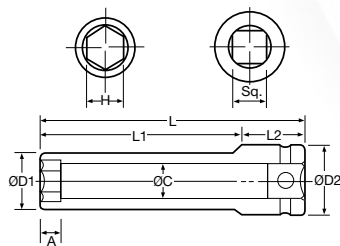
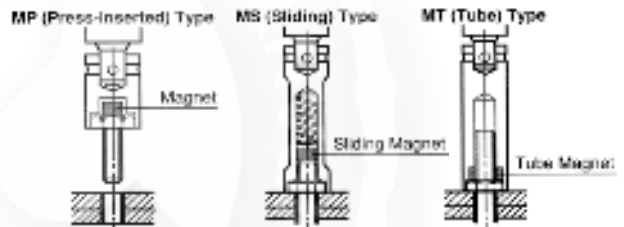

### SOCKET

Magnet			H	L	L1	L2	A	ØC	ØD1	ØD2	Sq.
MP	MT	MS	SIZE								
			TYPE								

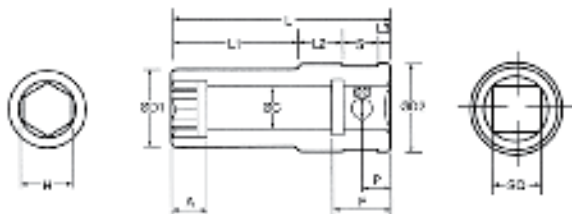

### Nutrunner Socket Type A

Min. Qty 10

Magnet			H	L	L1	L2	L3	S	ØD1	A	ØC	ØG	P	F	ØD2	Sq.	Qty.
MP	MT	MS	SIZE														
			TYPE														

✓ box for Ergo Drive

# Special Parts

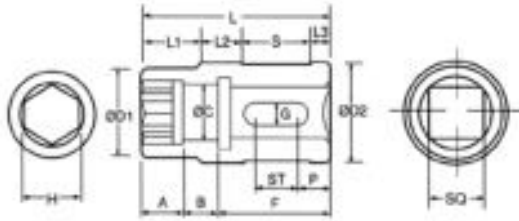

Nutrunner Socket Type B

Min. Qty 10

	H	L	L1	L2	L3	S	ØD1	A	B	ØC	G	P	F	ST	ØD2	Sq.	Qty.
SIZE																	
TYPE																	

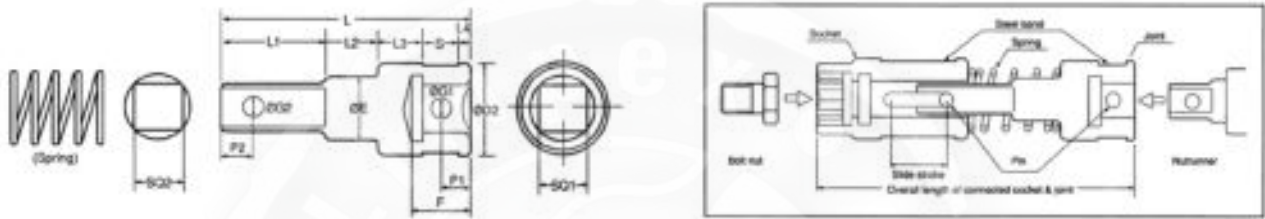

Nutrunner Joint Type B

Min. Qty 10

	SQ2	L	L1	L2	L3	L4	S	P1	ØG2	ØE	F	ØG1	P2	ØD2	SQ1	Qty.
SIZE																
TYPE																

✓ box for Ergo Drive

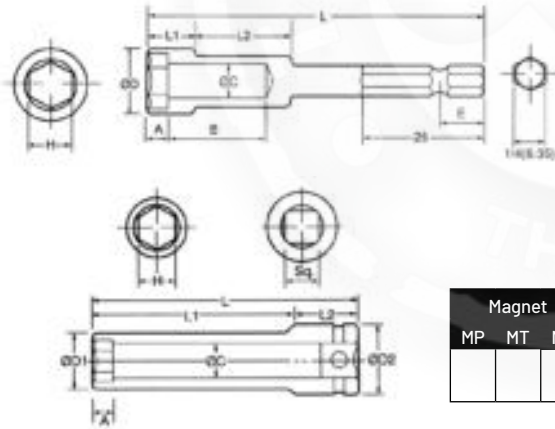

Nutrunner Socket Type B

Min. Qty 10

	H	ØD	L	E	L1	L2	A	B	ØC	Qty.
SIZE										
TYPE										

Socket

Min. Qty 10

Magnet	H	L	L1	L2	A	ØC	ØD1	ØD2	Sq.	Qty.
MP MT MS										
SIZE										
TYPE										

✓ box for Ergo Drive

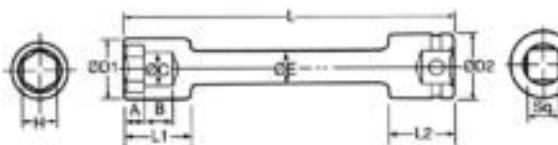

Extension Socket

Min. Qty 10

Magnet	H	L	L1	L2	A	B	ØC	ØD2	ØE	Sq.	Qty.
MP MT MS											
SIZE											
TYPE											

✓ box for Ergo Drive

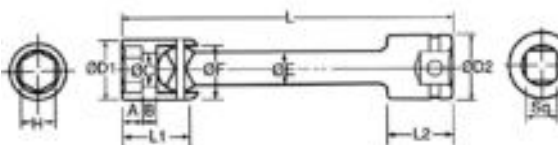

Universal Socket

Min. Qty 10

Magnet	H	L	L1	L2	A	B	ØC	ØD1	ØD2	ØE	ØF	Sq.	Qty.
MP MT MS													
SIZE													
TYPE													

✓ box for Ergo Drive

# Special Parts

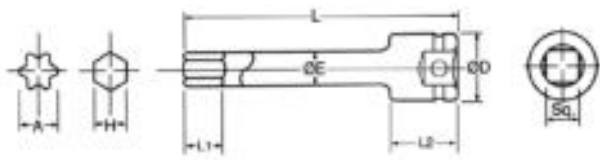

## Allen Head / Torx Head

Min. Qty 10

Torx	H	L	L1	L2	ØD	ØE	ØF	Sq.	Qty.
								<input type="checkbox"/>	

box for Ergo Drive

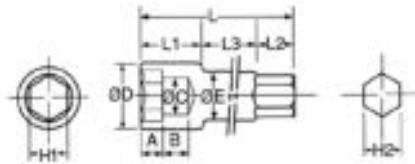

## Socket Adapter

Min. Qty 10

H1	L	L1	L2	L3	ØD	A	B	ØC	ØE	H2	Qty.
SIZE											
TYPE											

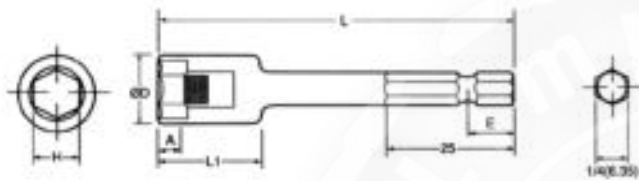

## (MP) Magnetic Nut Setter

Min. Qty 10

H	L	E	L1	ØD	A	Qty.
SIZE						
TYPE						

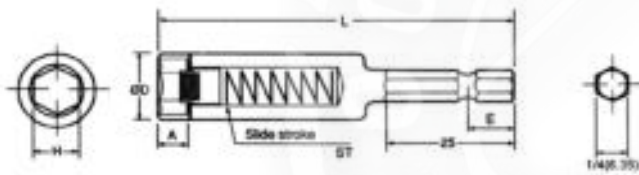

## (MS) Magnetic Nut Setter

Min. Qty 10

H	L	E	ØD	A	ST	Qty.
SIZE						
TYPE						

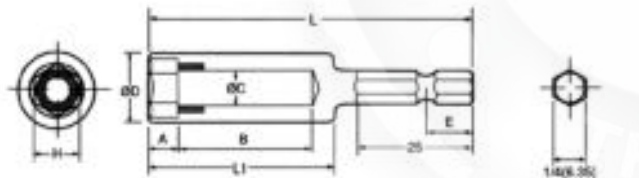

## (MT) Magnetic Nut Setter

Min. Qty 10

H	L	E	L1	ØD	A	B	ØC	Qty.
SIZE								
TYPE								

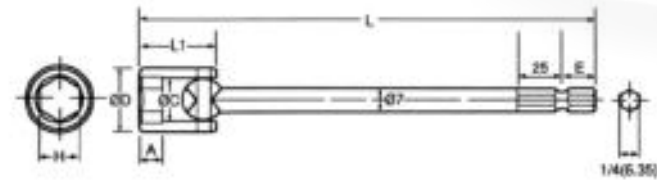

## Universal Nut Setter

Min. Qty 10

H	L	E	L1	A	ØC	ØD	Qty.

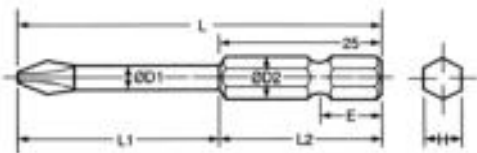

## Screwdriver Bit

Min. Qty 500

Point Size	L	L1	L2	ØD1	ØD2	E	H	Qty.

CIRCLE ONE:



Philips®



Slotted



Torx®



Torx®  
Tamper Resistant



Fastdriv®



Supadriv®



Square Recess



Allen Head



Torq Set®



Tri-Ming®



# Index

MODEL #	PAGE	MODEL #	PAGE	MODEL #	PAGE	MODEL #	PAGE	MODEL #	PAGE
<b>A</b>									
A128A	162	A3BHM-4	163	A-50B-2	135	AB-B1825LI	55	ACA-V40-2500	139
A1220E	162	A3BHM-6	163	A-50B-3	135	AB-B1850LI	55	ACA-V80-1500	139
A1418E	162	A3BHM-8	163	A-50B-4	135	AB-C18-4W	55	ACA-V80-2000	139
A2100	136	A3BHM-10	163	A-50BRBT-1	135	AB-C18110	55	ACA-V80-2500	139
A2426E	162	A3S0-2	163	A-50BRBT-2	135	AB-C18220	55	ACA-V150-1500	139
A31/2EDS	165	A3S1-2	163	A-50BRBT-3	135	ABETP Cordless XT Series	115	ACA-V150-2000	139
A31/4	161	A3S1-2.75	163	A-50BRBT-4	135	ABN-CTA Cordless Angle Tools	52	ACA-V150-2500	139
A31/4C	162	A3S1-3	163	A-50BRBT-1	135	ABN-MTA Cordless Angle Tools	52	ACA-V220-1500	139
A31/4EDS	165	A3S1-3.5	163	A-50BRBT-2	135	ABP-CTA Cordless Pistol Tools	53	ACA-V220-2000	139
A31/4MP	161	A3S1-4	163	A-50BRBT-3	135	ABP-CTA Ultra Torque Cordless Pistol Tools	54	ACA-V220-2500	139
A33/8	161	A3S1-6	163	A-50CRBTRC-4	135	ABT-3	153	ACPTT-V15-510 150	143
A33/8MP	161	A3S2-1.2	163	A-50C-6	135	ABT-5	153	ACPTT-V15-710 300	143
A35/16	161	A3S2-1.6	163	A-50C-8	135	ABT-CTA Cordless Tubenut Tools	53	ACPTT-V40-510 150	143
A35/16MP	161	A3S3-2	163	A-50C-10	135	ACA10-1000	139	ACPTT-V40-760 300	143
A302A	162	A3S3-2.75	163	A-50CRBT-6	135	ACA10-1500	139	ACPTT-V40-1410 600	143
A304C	162	A3T6-2	163	A-50CRBT-8	135	ACA15-1000	139	ACPTT-V80-810 300	143
A306	161	A3T7-2	163	A-50CRBT-10	135	ACA15-2000	139	ACPTT-V80-1410 600	143
A306EDS	165	A3T7-2.75	163	A-50CRBTRC-6	135	ACA15-2500	139	ACSA-600-1500	143
A307	161	A3T7-3.5	163	A-50CRBTRC-8	135	ACA15-3000	139	ACSA-800-1500	143
A307-2	161	A3T7-6	163	A-50CRBTRC-10	135	ACA15-4000	139	ACSA-1000-1500	143
A307-2.75	161	A3T8-2	163	A504A	162	ACTT-V15-600 150	142	ACTT-V15-800 300	142
A308	161	A3T9-2.75	163	A#508A	162	ACTT-V40-600 150	142	ACTT-V40-850 300	142
A308-2	161	A3W1-3	163	A61-1/2EDS	165	ACTT-V40-1500 600	142	ACTT-V40-1500 600	142
A308EDS	165	A3W2-2	163	A61-1/4EDS	165	ACTT-V80-900 300	142	ACTT-V80-1500 600	142
A308MP	161	A3W2-3	163	A61-1/8EDS	165	ACTT-V80-2100 900	142	ADC-2S	162
A310EDS	165	A3W2-4	163	A63/4	161	ADC-3S	162	ADC-3SEDSQ	165
A310MP	161	A3W2-6	163	A63/4-4	161	ADC-3SH7/16Z	162	ADC-4S	162
A310U	162	A3W2-8	163	A604A	162	ADC-4SEDSQ	165	ADC-4SH7/16Z	162
A311MP	161	A3W2-10	163	A610E	162	ADC-4SH7/16Z	162	AD-D1098-P	138
A311U	162	A3W2-12	163	A611/16	161	AD-D1098-PAC	138	AD-D1098-PACE	138
A312EDS	165	A3W3-2	163	A611/16-4	161	AD-D1098-S	138	AD-D1098-SAC	138
A314EDS	165	A3W3-3	163	A613/16	161	ADM Series 3arm	150	ADS Series 3arm	150
A315V	136	A3W3-4	163	A613/16-4	161	AE-224PS	129	AE-278PS	129
A316EDS	165	A3W3-6	163	A614	161	AE-2015	128	AE-2020	127
A318EDS	165	A3W3-8	163	A616	161	AE-2045A	129	AE-4020	127
A325EDE	165	A41/2	161	A617	161	AE-4520	127	AE-4520ESD	127
A375E	162	A41/2-3.25	161	A617-4	161	AE-5681	127	AE-5681ESD	127
A375EDE	165	A41/2EDS	165	A618-4	161	AE-6300M	128	AE-6450	128
A375EDE	165	A41/4C	162	A618EDS	165	AE-7010	127	AE-7010PS	127
A3100EDE	165	A43/8	161	A619-4	161	AE-7080A	129	AE-8681	127
A3150EDE	165	A43/8-3.25	161	A619A	161	AED4A 6000 Series HT Tools	33	AED4A 7000 Series HT Tools	33
A3190EDE	165	A47/16	161	A624EDS	165	AED4A 8000 Series HT Tools	33	AED4B 6000 Series HT Tools	34
A3254EDE	165	A47/16-3.25	161	A676EDE	165	AED4B 7000 Series HT Dual-Lever Tools	39	AED4B 8000 Series HT Tools	34
A3300EDE	165	A403A	162	A6100EDE	165	AED4W 8000 Series HT Tools	34	AEF3 5000 Series Fixtured Tools	30
A3320EDE	165	A405C	162	A6150EDE	165	AEF4 1000 Series Fixtured Tools	19	AEF4 6000 Series HT Dual-Lever Tools	39
A3B1/4-2	162	A405E	162	A6200EDE	165	AEF4 6000 Series HT Tools	33	AEF4 7000 Series HT Dual-Lever Tools	39
A3B1/4-2.5	162	A408	161	A81	161	AEF4 7000 Series HT Tools	33	AEF4 8000 Series HT Dual-Lever Tools	39
A3B3/8-2	162	A408MP	161	A87/8	161	AEF4 8000 Series HT Dual-Lever Tools	39	AEF4 9000 Series HTXD Tools	41
A3B3/8-2.5	162	A409	161	A806A	162	AEF4B 6000 Series HT Dual-Lever Tools	39	AEF4B 7000 Series HT Dual-Lever Tools	39
A3B05-2.75	162	A410	161	A810E	162	AEF4B 8000 Series HT Tools	34	AEF4B 9000 Series HT Tools	34
A3B5/16-2	162	A410-2	161	A815/16	161	AEF4C 6000 Series HT Dual-Lever Tools	39	AEF4C 7000 Series HT Dual-Lever Tools	39
A3B5/16-2.5	162	A410-3	161	A815/16EDS	165	AEF4C 8000 Series HT Dual-Lever Tools	39	AEF4C 9000 Series HT Dual-Lever Tools	39
A3B06-2.75	162	A410-3.25	161	A817	161	AEF4D 6000 Series HT Dual-Lever Tools	39	AEF4D 7000 Series HT Dual-Lever Tools	39
A3B07-1.2	162	A410MP	161	A819	161	AEF4D 8000 Series HT Tools	34	AEF4D 9000 Series HT Tools	34
A3B07-2	162	A411-3.25	161	A821	161	AEF4E 6000 Series HT Dual-Lever Tools	39	AEF4E 7000 Series HT Dual-Lever Tools	39
A3B07-2.75	162	A412MP	161	A8210EDS	165	AEF4E 8000 Series HT Dual-Lever Tools	39	AEF4E 9000 Series HT Dual-Lever Tools	39
A3B07-4	162	A412U	162	A8150EDE	165	AEF4E 1000 Series HT Dual-Lever Tools	39	AEF4E 1500 Series HT Dual-Lever Tools	39
A3B08-1.2	162	A413EDS	165	A8200EDE	165	AEF4E 2000 Series HT Dual-Lever Tools	39	AEF4E 2500 Series HT Dual-Lever Tools	39
A3B08-2	162	A413EDS	165	AAP1B66400A	100	AEF4E 3000 Series HT Dual-Lever Tools	39	AEF4E 3500 Series HT Dual-Lever Tools	39
A3B08-2.75	162	A413U	162	AAP1B66600A	100	AEF4E 4000 Series HT Dual-Lever Tools	39	AEF4E 4500 Series HT Dual-Lever Tools	39
A3B08-4	162	A414EDS	165	AAP1B66850A	100	AEF4E 5000 Series HT Dual-Lever Tools	39	AEF4E 5500 Series HT Dual-Lever Tools	39
A3B08-6	162	A415EDS	165	AAP1B771350A	100	AEF4E 6000 Series HT Dual-Lever Tools	39	AEF4E 6500 Series HT Dual-Lever Tools	39
A3B08-8	162	A416EDS	165	AAP1B772000A	100	AEF4E 7000 Series HT Dual-Lever Tools	39	AEF4E 7500 Series HT Dual-Lever Tools	39
A3B09-2.75	162	A417EDS	165	AAP1B772950A	100	AEF4E 8000 Series HT Dual-Lever Tools	39	AEF4E 8500 Series HT Dual-Lever Tools	39
A3B09-4	162	A418EDS	165	AAP1B772950A	100	AEF4E 9000 Series HT Dual-Lever Tools	39	AEF4E 9500 Series HT Dual-Lever Tools	39
A3B10-1.2	162	A419EDS	165	AAP1B885100A	100	AEF4E 1000 Series HT Dual-Lever Tools	39	AEF4E 1500 Series HT Dual-Lever Tools	39
A3B10-2	162	A464EDE	165	AAP2B76250A(R)	101	AEF4E 2000 Series HT Dual-Lever Tools	39	AEF4E 2500 Series HT Dual-Lever Tools	39
A3B10-2.75	162	A476EDE	165	AAP2B76450A(R)	101	AEF4E 3000 Series HT Dual-Lever Tools	39	AEF4E 3500 Series HT Dual-Lever Tools	39
A3B11-2.75	162	A4125EDE	165	AAP2B76650A(R)	101	AEF4E 4000 Series HT Dual-Lever Tools	39	AEF4E 4500 Series HT Dual-Lever Tools	39
A3B12-1.2	162	A4204EDE	165	AAP2B76950A(R)	101	AEF4E 5000 Series HT Dual-Lever Tools	39	AEF4E 5500 Series HT Dual-Lever Tools	39
A3B13-2.75	162	A4254EDE	165	AAP2B771400A(R)	101	AEF4E 6000 Series HT Dual-Lever Tools	39	AEF4E 6500 Series HT Dual-Lever Tools	39
A3B14-2.75	162	A4355EDE	165	AAP2B772000A(R)	101	AEF4E 7000 Series HT Dual-Lever Tools	39	AEF4E 7500 Series HT Dual-Lever Tools	39
A3B16-2.75	162	A-50A-0	135	AAP2B773000A(R)	101	AEF4E 8000 Series HT Dual-Lever Tools	39	AEF4E 8500 Series HT Dual-Lever Tools	39
A3B17-2.75	162	A-50A-1.7	135	AAP2B785100A(R)	101	AEF4E 9000 Series HT Dual-Lever Tools	39	AEF4E 9500 Series HT Dual-Lever Tools	39
A3B55-1.2	162	A-50ARB-0	135	AB-PBAIL	55	AEF4E 1000 Series HT Dual-Lever Tools	39	AEF4E 1500 Series HT Dual-Lever Tools	39
A3B55-2.75	162	A-50ARB-1.7	135	AB-PCOLRING	55	AEF4E 2000 Series HT Dual-Lever Tools	39	AEF4E 2500 Series HT Dual-Lever Tools	39
A3B55-4	162	A-50ARBTC-0	135	AB-3	153	AEF4E 3000 Series HT Dual-Lever Tools	39	AEF4E 3500 Series HT Dual-Lever Tools	39
A3BHM-3	163	A-50ARBTC-1.7	135	AB-3/5	153	AEF4E 4000 Series HT Dual-Lever Tools	39	AEF4E 4500 Series HT Dual-Lever Tools	39
		A-50B-1	135	AB-5	153	AEF4E 5000 Series HT Dual-Lever Tools	39	AEF4E 5500 Series HT Dual-Lever Tools	39

# Index

MODEL #	PAGE	MODEL #	PAGE	MODEL #	PAGE	MODEL #	PAGE	MODEL #	PAGE
AEF4B 8000 Series HT Dual-Lever Tools	39	AES4A 6000 Series HT Tools	33	APM-30	129	ARTIS-385-75T(A)	95	AUET-0100(-DC)	81
AEF4C 1000 Series Fitted Tools	19	AES4A 7000 Series HT Dual-Lever Tools	39	APTH-12ADP	91	ARTIS-505-180T(A)	95	AUET-250(-DC)	81
AEFJA 8000 Series HT Dual-Lever Tools	39	AES4A 7000 Series HT Tools	33	APTH-12BLANK	91	ARTIS-755-250T(A)	95	AUET-500(-DC)	81
AEH3 3000 Series Hold & Drive Tools	27	AES4A 8000 Series HT Tools	33	APTH-120E7	91	ARTIS-755-500T(A)	95	AUET-1000(-DC)	81
AEH3 5000 Series Hold & Drive Tools	31	AES4B 6000 Series HT Dual-Lever Tools	39	APTH-120E8	91	ARTIS-1005-1400T(A)	95	AUET-1200(-DC)	81
AEH4F 2000 Series Hold & Drive Tools	22	AES4B 7000 Series HT Dual-Lever Tools	39	APTH-120E9	91	ARTIS-25H-10T(A)	95	AUET-1800(-DC)	81
AEJ4A 6000 Series HT Tools	33	AES-5	153	APTH-120E10	91	ARTIS-255-20T(A)	95	AUET/MTM-10-100	81
AEJ4A 7000 Series HT Tools	33	AET4A 1000 Series Tubenut Tools	19	APTH-120E11	91	ARTIS-385-25T(A)	95	AUET/MTM-050-25	81
AEJ4A 8000 Series HT Tools	33	AET4A 2000 Series Tubenut Tools	22	APTH-120E12	91	ARTIS-1005-750T(A)	95	AUET/MTM-50-250	81
AEJ4B 6000 Series HT Tools	34	AE-TC2040	129	APTH-120E13	91	ASB-0C	155	AUET/MTM-50-500(-DC)	81
AEJ4B 7000 Series HT Tools	34	AE-TC7080	129	APTH-120E14	91	ASB-3C	155	AUET/MTM-050-600	81
AEJ4B 8000 Series HT Dual-Lever Tools	39	AEX4A 1000 Series Fitted Tools	19	APTH-120E15	91	ASB-5C	155	AUET/MTM-50-1000(-DC)	81
AEJ4B 8000 Series HT Tools	34	AFRL-4	100, 157	APTH-120E16	91	ASB Series 3arm	149	AUET/MTM-0100-050	81
AEJ4U 9X Series HTXD Tools	41	AFRL-4HTA	100, 157	APTH-120E17	91	ASBS Series 3arm	149	AUET/MTM-100-500	81
AEJ4U 9Y Series HTXD Tools	41	AFRL-2	157	APTH-120E18	91	ASC-3	153	AUET/MTM-100-1000	81
AEJ4U 9000 Series HTXD Tools	41	AFRL-2-C	157	APTH-120E19	91	ASC-5	153	AUET/MTM-100-1200	81
AEJ4W 9X Series HTXD Tools	41	AFRL-3	157	APTH-120E20	91	ASH-250C-10MSZ	158	AUET/MTM-100-1600(-DC)	81
AEJ4W 9Y Series HTXD Tools	41	AFRL-3-C	157	APTH-120E50	91	ASH-250C-15MSZ	158	AUET/MTM-100-2000	81
AEJ4W 8000 Series HT Tools	34	AFRL-8	157	APTH-12RE50	91	ASH-250C-25MSZ	158	AUET/MTM-250-1600	81
AEJ4W 9000 Series HTXD Tools	41	AHB-3	153	APTH-12RT25	91	ASH-375C-15MSZ	158	AUET/MTM-250-1800	81
AEL4A 1000 Series Inline		AHB-5	153	APTH-12RT38	91	ASH-375C-25MSZ	158	AUET/MTM-250-2500	81
Push-To-Start Tools	18	AHCTS-0.5K	87	APTH-12RT50	91	ASH-375Z	158	AUET/MTM-500-1200	81
AEN3 3000 Series Angle Tools	26	AHCTS-1.5RDF	86	APTH-12SD25	91	ASH-500C-15MSZ	102, 158	AUET/MTM-500-2500(-DC)	81
AEN3 5000 Series Angle Tools	29	AHCTS-001K	87	APTH-12SD38	91	ASH-500C-25MSZ	102, 158	AVC-5	153
AEN3 5000 Series HT Angle Tools	35	AHCTS-1RDF	86	APTH-12SD50	91	ASH-500Z	102, 158	AW3F	153
AEN4B 7000 Series HT Angle Tools	37	AHCTS-2.5K	87	APTH-14ADP	91	ASTIS-25D-11	96	AW3FMF	154
AEN4C 1000 Series Angle Tools	18	AHCTS-3/4RDF	86	APTH-14ABLANK	91	ASTIS-25D-28	96	AW3S	153
AEN4C 2000 Series Angle		AHCTS-005K	87	APTH-140E1	91	ASTIS-38D-135	96	AWGF	153
Mid-Exit Cable Tools	23	AHCTS-010K	87	APTH-140E13	91	ASTIS-50D-270	96	AWGFMF	154
AEN4C 2000 Series Angle Tools	21	AHCTS-025K	87	APTH-140E14	91	ASTIS-75D-1000	96	AWGFMMS	154
AEN4F 2000 Series Angle		AHCTS-0500	87	APTH-140E15	91	ASTIS-100D-1700	96	AW6S	153
Mid-Exit Cable Tools	23	AHCTS-2500	87	APTH-140E16	91	AT3-3	153	AXD-2000	42
AEN4F 2000 Series Angle Tools	21	AHCTS-5000	87	APTH-140E17	91	AT3-4	153	AXD-2000B	42
AEP-3	153	AHCTS-7500	87	APTH-140E18	91	AT3-6	153		
AEP3 5000 Series Pistol Tools	28	AHCTS-5025	87	APTH-140E19	91	AT3-9	153	<b>B</b>	
AEP4A 1000 Series Pistol Tools	17	AICS-2	153	APTH-140E21	91	AT5-3	153	B23	159
AEP4A 1000 Series Riv-Nut Tools	32	AIMTS Test Stands	89	APTH-140E22	91	AT5-4	153	B23E	159
AEP4A 2000 Series Pistol Tools	20	AISF-200100	96	APTH-140E24	91	AT5-6	153	B25	159
AEP4A 2000 Series Riv-Nut Tools	32	AISF-200250	96	APTH-140E25	91	AT5-9	153	BA Series 3arm	148
AEP4A 2000 Series HT Dual-Lever Tools	39	AISF-201000	96	APTH-140E27	91	AT5-12	153	BB Series 3arm	148
AEP4A 6000 Series HT Tools	33	AISI-200025	96	APTH-140E30	91	ATC-10	80	BE Series 3arm	148
AEP4A 6000 Series HT Tools	33	AISI-200100	96	APTH-140E32	91	ATC-25	80	BJ10051	49
AEP4A 7000 Series HT Dual-Lever Tools	39	AISI-200500	96	APTH-140E34	91	ATC-100	80	BJ10052	49
AEP4A 7000 Series HT Tools	33	AISWT-4L	79	APTH-140E36	91	ATC-150F	80	BJ10053	49
AEP4A 8000 Series HT Dual-Lever Tools	39	AISWT-6L	79	APTH-140E38	91	ATC-250	80	BJ10054	49
AEP4A 8000 Series HT Tools	33	AJH-3	153	APTH-140E41	91	ATC-250F	80	BJ10055	49
AEP4A(R)(T)22020B(V)	20	AJH-5	153	APTH-140E118	91	ATC-500	80	BJ10076	45
AEP4B 6000 Series HT Tools	34	AJKR-28	98	APTH-140E138	91	ATC-500F	80	BJ10077	45
AEP4B 7000 Series HT Dual-Lever Tools	39	AJKR-135	98	APTH-14RE32	91	ATC-750	80	BJ10078	45
AEP4B 7000 Series HT Tools	34	AJKR-271	98	APTH-14RT34	91	ATC-750F	80	BJ10082	126
AEP4B 8000 Series HT		AJKR-1017	98	APTH-14RT50	91	ATC-1000	80	BJ10083	126
Dual-Lever Tools	39	AJKR-1695	98	APTH-14SD50	91	ATC-1800	80	BJ10091	124
AEP4B 8000 Series HT Tools	34	AJKS-25D	98	APTW-25	91	ATDA	83	BPRASC Series 3arm	150
AEP4B 9000 Series HT Tools	34	AJKS-38D	98	APTW-50	91	ATDA-DC	83	BPRASM Series 3arm	150
AEP4R 1000 Series Pistol Tools	17	AJKS-50D	98	APTW-100	91	ATDBLIS	99	BP-T40-(B) (KIT)	110
AEP4R 1000 Series Rivet Tools	32	AJKS-75D	98	APTW-150	91	ATDBRIS	99	BP-T40-RF8 (B) (KIT)	111
AEP4R 2000 Series Pistol Tools	20	AJKS-100D	98	APTW-200	91	ATM-800	119	BP-T40D-(B) (KIT)	110
AEP4R 2000 Series Rivet Tools	32	AJS3	153	APTW-340	91	ATM-1800	119	BP-T40D-RF8 (B) (KIT)	111
AEP4T 1000 Series Pistol		ALBM Series 3arm	149	ARDFA-100(HD)(HDE)(HDS)	97	ATM-2800	119	BP-T50-(B) (KIT)	110
Push-To-Start Tools	17	ALBS Series 3arm	149	ARDFA-150(HD)(HDE)(HDS)	97	ATM-3800	119	BP-T50-RF8 (B) (KIT)	111
AEP4T 1000 Series Pistol Tools	17	AM1/4Z	160	ARDFA-250(HD)(HDE)(HDS)	97	ATM-5000	119	BP-T50D-(B) (KIT)	110
AEP4T 2000 Series Pistol Tools	20	AM3/16Z	160	ARDFA-500(HD)(HDE)(HDS)	97	ATM-8000	119	BP-T50D-RF8 (B) (KIT)	111
AEP4T 2000 Series Rivet Tools	32	AM5/16Z	160	ARDFA-600(HD)(HDE)(HDS)	97	ATM-12000	119	BP-T60-(B) (KIT)	110
AEP4W 9X Series HTXD Tools	41	AMSZ	160	ARDFA-750(HD)(HDE)(HDS)	97	ATM-16000	119	BP-T60-RF8 (B) (KIT)	111
AEP4W 9Y Series HTXD Tools	41	AM-45	129	ARDIA-10(HD)(HDE)(HDS)	97	ATN-3	153	BP-T60D-(B) (KIT)	110
AEP4W 8000 Series HT Tools	34	AM-65	129	ARDIA-25(HD)(HDE)(HDS)	97	ATN-5	153	BP-T60D-RF8 (B) (KIT)	111
AEP4W 9000 Series HTXD Tools	41	AMP-5	153	ARDIA-50(HD)(HDE)(HDS)	97	ATW-50	154	BRH-1UD(R)	134
AEP-5	153	AMPST-2-I	49	ARDIA-100(HD)(HDE)(HDS)	97	ATW-0100F	92	BRH-1UR	134
AEP 2000 Series Discontinuous		AMPST-2-U	49	ARDIA-150(HD)(HDE)(HDS)	97	ATW-0200F	92	BRH-1USR	134
Drive Tools	25	AMPST-4-I	49	ARDIA-250(HD)(HDE)(HDS)	97	ATW-0500F	92	BRH-5UD(R)	134
AE-PG7080	129	AMPST-4-U	49	ARDIA-350(HD)(HDE)(HDS)	97	ATW-1000F	92	BRH-5USD	134
AES-3	153	AMPST-6-I	49	ARDIA-500(HD)(HDE)(HDS)	97	ATWL-2500	90	BRH-5USR	134
AES3 3000 Series Inline Tools	27	AMPST-6-U	49	ARDIA-750(HD)(HDE)(HDS)	97	ATWL-750	90	BRH-7(R,H)	134
AES3 5000 Series Inline Tools	29	AMPST-6S-I	49	ARDIA-1000(HD)(HDE)(HDS)	97	ATWL-1000	90		
AES4A 1000 Series Inline Tools	18	AMPST-6S-U	49	ARTIS-25H-2T(A)	95	AU-5	153	<b>C</b>	
AES4A 2000 Series Inline		AMPST-8-I	49	ARTIS-25H-5T(A)	95	Audit Manager Software	85	CA150108DHD	86
Mid-Exit Cable Tools	23	AMPST-8-IL	49	ARTIS-25H-20T(A)	95	AUET-10(-DC)	81	CA1510	86
AES4A 2000 Series Inline Tools	21	AMPST-8-U	49	ARTIS-255-10T(A)	95	AUET-50(-DC)	81	CA1550	86
AES4A 6000 Series HT Dual-Lever Tools	39								

# Index

MODEL #	PAGE	MODEL #	PAGE	MODEL #	PAGE	MODEL #	PAGE	MODEL #	PAGE		
CA1575	.86	<b>P</b>	TW-50	155	UAT-150	105	UL-70S	106			
CA2510L	.86		TW-60	155	UAT-180	105	UL-80	106			
CA2515L	.86		TW-70	155	UAT-200	105	UL-90	106			
CA2575L	.86		<b>U</b>	U-310SD	108	UAT-200L	105	UL-100	106		
CC-6000-F	.45			U-350D	108	UBX-AF(Z) Series	.63	UL-130	106		
CC-6000-FIP	.45			U-350SD	108	UBX-T Series	113	UL-150	106		
CC-7000-F	.45			UA-40DMC	.59	UCC-100Z	68, 69	UL-200	106		
CC-7000-FIP	.45			UA-40MC	.59	UD-50-22	133	UL-40C	107		
CC-8000-F	.45			UA-40SMC	.59	UD-50-45	133	UL-50C	107		
CC-8000-FIP	.45			UA-40SDMC	.59	UD-50-200	133	UL-60C	107		
CVF Series Anti-Marring Sockets	.161			UA-40SMC	.59	UD-50S-22	133	UL-70C	107		
CV Series Anti-Marring Sockets	.161			UA-40SMC	.59	UD-50S-45	133	UL-70CH	107		
<b>D</b>	DM Series 3arm			150	UA-50DMC	.59	UD-50S-45A	133	UNR-F015-25NTC	.74	
	DS Series 3arm			150	UA-50MC	.59	UD-50S-45A*	133	UNR-F015-45NT	.73	
	<b>E</b>			EC/MCCBL-10	.70	UA-50SDMC	.59	UD-60-04	133	UNR-F015-55NTC	.74
				EC/MCCBL-25	.70	UA-50SMC	.59	UD-60-07	133	UNR-F015-65NT	.73
				EC/MCCBL-30	.70	UA-50SMC	.59	UD-60-15	133	UNR-F015-200NT	.73
				EC/MCCBL-35	.70	UA-60MC	.59	UD-60-15	133	UNR-F015-280NT	.73
				EC/MCCBL-40	.70	UA-60SDMC	.59	UD-60-20	133	UNR-F015-350NT	.73
				EC/MCCBL-45	.70	UA-60SMC	.59	UD-60-29	133	UNR-F050-95NTC	.74
		EC/MCCBL-50		.70	UA-70MC	.59	UD-60S-15	133	UNR-F050-130NTC	.74	
		EC/MCCBL-60		.70	UA-70SMC	.59	UD-60S-15C	133	UNR-F050-270NT	.73	
		EC/MCCBL-75		.70	UA-80MC	.59	UD-60S-29	133	UNR-F050-630NT	.73	
		EY0L82B	63, 111, 113	UA-90MC	.59	UD-60S-29C	133	UNR-F050-730NT	.73		
	EYFB32	63, 111	UA-100MC	.59	UD-80-04	133	UNR-F050-880NT	.73			
	EYFB41	63, 111, 113	UA-130MC	.59	UD-80-07	133	UNR-F050-1400NT	.73			
	EYFB43B	63, 113	UA-150MC	.59	UD-80-12	133	UNR-F100-200NTC	.74			
	EYFB50	63, 113	UA-400AMC	.60	UDP-A100MC	.61	UNR-F100-250NTC	.74			
	<b>F</b>	F70	145	UA-500AMC	.60	UDP-A120MC	.61	UNR-F100-380NTC	.74		
		F600	145	UA-600AMC	.60	UDP-A600LMC	.61	UNR-F100-550NTC	.74		
		F1500	145	UA-700AMC	.60	UDP-A700MC	.61	UNR-F100-1300NT	.73		
		F3000	145	UA-800AMC	.60	UEC-4801A	65, 69	UNR-F100-1900NT	.73		
F7500		145	UA-900AMC	.60	UEC-4801A-ANGLE	.69	UNR-F100-2500NT	.73			
FA-50-2		154	UA-1000AMC	.60	UEC-5500	66, 69	UNR-F100-3700NT	.73			
<b>G</b>		Gen IV ACE Controller	.7	UA-1300AMC	.60	UEC-F024H	.71	UNR-F100-5400NT	.73		
		Gen IV Smart Arm System with Process Visualization	.15	UAG-40SBL-136	132	UEC-F060H	.71	UNR-F100-7000NT	.73		
		<b>I</b>	iAC4E Series Gen IV Controller	.11	UAG-50SBL-109	132	UEC-F120H	.71	UNR-F100-10000NT	.73	
			iBC4E Series Gen IV Controller	.12	UAG-50SBL-120	132	UEC-F300MII	.72	UOW-11-10	118	
	iBC4E-Z Series Gen IV Controller		.12	UAG-70SBL-76	132	UEC-MKB	.72	UOW-11-14	118		
	ICBL-4P		.99	UAG-90SBL-59	132	UECP-4810(A)	67, 69	UOW-11-22	118		
	ICBL-10P		.99	UAN-611R-30C	116	UFT-6	.98	UOW-11-30	118		
	ICBL-5000L		.99	UAN-611R-40C	116	UFT-10	.98	UOW-T60-10	118		
	ICBL-8000DIG		.99	UAN-611R-50C	116	UFT-16	.98	UOW-T60-14	118		
	ICBL-USB		.99	UAN-611R-60C	116	UFT-24	.98	UOW-T60-22	118		
iEC4E Series Gen IV Controller	.11		UAN-701R-30C	116	UFT-510	.98	UOW-T60-30	118			
iEC4WF	.43		UAN-701R-40C	116	UFT-516	.98	UP-25DB	133			
IP4	145	UAN-701R-60C	116	UG-25NA	132	URW-6	117				
IP5	145	UAT-30D	105	UG-38L	132	URW-8	117				
IP7	145	UAT-40S	105	UG-38NA	132	URW-8N	117				
IP8T	145	UAT-40	105	UG-38NL	132	URW-9N	117				
iPC4E Series Gen IV Controller	.12	UAT-40D	105	UG-38NS	132	URW-10N	117				
IPT150	145	UAT-40S	105	UG-45H	132	URW-12N	117				
IPT375	145	UAT-40SD	105	UG-50S-200	132	URW-12NA	117				
ITVC	.94	UAT-50	105	UG-50S-200A	132	US-3.5ACB	123				
<b>J</b>	JJ30	154	UAT-50D	105	UG-60S-29	132	US-3.5B	123			
	JJ30-S	154	UAT-50DL	105	UG-65EB	132	US-5	123			
	JJ30-TA	154	UAT-50L	105	UG-65EBL	132	US-6W	123			
	<b>L</b>	LR-09B-90	156	UAT-50S	105	UG-650EL	132	US-350PW	123		
		LR-09B-200	156	UAT-50SD	105	UG-1250L-72	132	US-450PW	123		
		<b>M</b>	MAG-O-NETS	160	UAT-50SDL	105	UGW-6N	118	US-450WB	123	
			MARK-XXXX	160	UAT-50SL	105	UGW-8N	118	US-652PW	123	
			TA-50-2	154	UAT-60	105	UL-30	106	US-LD40P-08	123	
			Tool Manager Software	.84	UAT-60D	105	UL-30D	106	US-LD40P-15	123	
			TS-20NP-2NPT	159	UAT-60L	105	UL-30S	106	US-LD40P-21	123	
TS-20US-2NPT			159	UAT-60S	105	UL-30SD	106	US-LD50P-05	123		
TS-30NP-2NPT			159	UAT-60SD	105	UL-40	106	US-LD50P-08	123		
TS-30US-2NPT			159	UAT-60SDL	105	UL-40D	106	US-LD50P-17	123		
TS-30NP-2NPT	159		UAT-60SL	105	UL-40S	106	US-LT10B	120			
TS-30US-3NPT	159		UAT-70	105	UL-40SD	106	US-LT20B-10	120			
TW-00	155	UAT-70L	105	UL-50	106	US-LT20B-18	120				
TW-0	155	UAT-70S	105	UL-50D	106	US-LT30B-11	120				
TW-3	155	UAT-70SL	105	UL-50S	106	US-LT30B-11C	121				
TW-5	155	UAT-80	105	UL-50SD	106	US-LT30B-17	120				
TW-9	155	UAT-90	105	UL-60	106	US-LT30B-17C	121				
TW-15	155	UAT-90L	105	UL-60D	106	US-LT30B-23	120				
TW-22	155	UAT-100	105	UL-60S	106	US-LT30BL-11	121				
TW-30	155	UAT-100L	105	UL-60SD	106	US-LT30BL-17	121				
TW-40	155	UAT-130	105	UL-70	106	US-LT31PB-05	121				

# Index

MODEL #	PAGE	MODEL #	PAGE	MODEL #	PAGE	MODEL #	PAGE	MODEL #	PAGE
US-LT31PB-11	121	<b>Numbers</b>		26477	.45	858-832-1	.117	910-567-0	.61
US-LT31PB-17	121	0007.08	.70	26478	.45	858-833-1	.117	910-568-0	.61
US-LT31PB-23	121	1AM1DS Series 3arm	.148	26479	.45	858-834-1	.117	910-569-0	.61
US-LT40-03C	121	1SN1DS Series 3arm	.148	26568	.50	858-835-1	.117	910-623-0	.70
US-LT40-05C	121	200-656-5	.117	26570	.50	858-836-1	.117	910-625-0	.61
US-LT40-08C	121	201-656-1	.117	26630	.45	858-837-1	.117	910-807-0	.61, 70
US-LT40B-03C	121	203-656-1	.117	26800	.45	858-838-1	.117	910-808-0	.61, 70
US-LT40B-05C	121	204-656-1	.117	26810	.45	858-839-1	.117	910-831-0	.109
US-LT40B-08	120	207-656-1	.117	26815	.45	858-869-1	.117	910-832-0	.109
US-LT40B-08C	120	209-656-1	.117	26820	.45	858-922-1	.117	911-023-0	.70
US-LT40B-15	120	209P-6-4	.159	26830	.45	858-938-1	.117	932-100-0	.159
US-LT40B-15C	121	209P-8-6	.159	26840	.45	858-941-1	.118	932-110-0A	.159
US-LT40B-21	120	210-656-1	.117	26885	.45	858-960-1	.118	976-379-0	.122
US-LT40BL-08	121	211-656-1	.117	26890	.45	858-966-1	.118	976-430-0	.122
US-LT40BL-15	121	212-656-1	.117	27045	.45	858-967-1	.118	976-431-0	.122
US-LT41PB-08	121	213-656-1	.117	27110	.48	858-968-1	.118	976-432-0	.122
US-LT41PB-15	121	214-656-1	.117	27115	.48	858-971-1	.118	976-471-0	.122
US-LT41PB-21	121	215-656-1	.117	27122	.48	858-972-1	.118	976-472-0	.122
US-LT50B-05	120	216-656-1	.117	27200	.45	858-973-1	.118	976-493-0	.122
US-LT50B-08	120	217-656-1	.117	27255	.45	858-974-1	.118	976-504-0	.122
US-LT50B-17	120	221-656-1	.117	27348	.48	858-976-1	.118	976-515-0	.122
US-LT51PB-05	121	222-656-1	.117	27594	.50	858-977-1	.118	976-516-0	.122
US-LT51PB-08	121	222P-6-4	.159	27768	.102	858-981-1	.118	976-517-0	.122
US-LT51PB-17	121	222P-8-6	.159	27769	.102	858-982-1	.118	976-588-0	.122
US-LT60P-03	121	222P-12-8	.159	27771	.102	858-983-1	.118	976-614-0	.122
US-LT60P-07	121	223-656-1	.117	27791	.50	858-992-1	.118	976-620-0	.122
US-LT60P-11	121	225-656-1	.117	27816	.50	858-994-1	.118	10C-840-1	.111
UTM-1500	109	226-656-1	.117	28050	.44	858-999-1	.118	10E-840-1	.111
UW-6CSHRK	131	227-656-1	.117	28161	.102	862-500-1	.118		
UW-6SLRDK	130	233-447-0	.118	28162	.102	862-501-1	.118		
UW-6SLRK	130	233-447-4	.118	28163	.102	862-503-1	.118		
UW-6SSHRDK	130	234-447-0	.118	28164	.102	862-511-1	.118		
UW-6SSHRK	130	234-447-6	.118	28178	.100, 157	862-513-1	.118		
UW-6SSLRDK	130	246-447-0	.118	28292	.48	862-514-1	.118		
UW-6SSRK	130	246-447-5	.118	28475	.50	862-516-1	.118		
UW-8SHRK	130	250-RZ	.159	28480	.44	862-530-1	.118		
UW-9SRK	130	250-SZ	.159	28489	.48	862-531-1	.118		
UW-10SHRK	130	20322	.50	28514	.45	862-532-1	.118		
UW-13CSK	131	20400	.49	28549	.45	862-533-1	.118		
UW-13SRK	130	20853	.50	28622	.50	862-535-1	.118		
UW-13SSK	130	21159	.50	28796	.102, 158	862-542-1	.118		
UW-61ERK	130	21208	.50	28843	.30	862-545-1	.118		
UW-75S	131	21226	.50, 126, 154	28859	.49	862-546-1	.118		
UW-131ERK	130	23575	.50	375-RZ	.159	862-548-1	.118		
UW-140P(WR)	131	23662	.50	375-SZ	.159	862-579-1	.118		
UW-220P	131	23730	.48	30300	.45	862-590-1	.118		
UW-220PL	131	24320	.48	30303	.45	862-714-1	.118		
UW-251P	131	24330	.48	30306	.45	862-728-1	.118		
UW-381	131	24924	.50	30340	.50	862-747-1	.118		
UW-381L	131	25265	.50	30351	.50	862-756-1	.118		
UW-381P	131	25274	.45	30355	.48	862-760-1	.118		
UW-401	130	25275	.45	30850	.49	863-000-1	.118		
UW-401L	130	25276	.45	31273	.45	863-001-1	.118		
UW-550	131	25277	.45	4H2055	.129	863-002-1	.118		
UW-ST6SHK	131	25278	.45	500-SZ	.102, 159	863-003-1	.118		
UX-500C	108	25287	.45	7021	.159	863-004-1	.118		
UX-612C	108	25289	.45	7021AG	.159	863-026-1	.118		
UX-700C	108	25291	.45	7041A	.159	878-845-1	.109		
UX-800C	108	25350	.48	7041AG	.159	881-016-1	.117		
UX-900S	108	25491	.48	7051	.159	881-087-1	.117		
UX-1000C	108	25501	.50	205-656-1	.117	881-090-1	.117		
UX-1000S	108	25518	.48	852-644-1 (KIT)	.70	881-091-1	.117		
UX-1300S	108	25717	.50	852-645-1 (KIT)	.70	881-150-1	.117		
UXR-1820MC	.61	25718	.50	852-669-1 (KIT)	.70	881-160-1	.117		
UXR-2000	108	25843	.50	858-626-1	.117	881-161-1	.117		
UXR-2000MC	.61	26327	.45	858-655-1	.117	881-162-1	.117		
UXR-2400SMC	.61	26328	.45	858-741-1	.117	881-163-1	.117		
UXR-T2400S	108	26332	.45	858-753-1	.117	881-164-1	.117		
UXR-T3000S	108	26336	.45	858-792-1	.117	881-167-1	.117		
UX-ST800	108	26337	.45	858-794-1	.117	881-168-1	.117		
		26364	.48	858-818-1	.117	909-749-0	.61		
		26394	.50	858-830-1	.117	910-547-0	.70		
<b>W</b>		26443	.50	858-831-1	.117	910-548-0	.70		
WSCH	153								





Hrabinská 498/19, 737 01 Český Těšín, Česká republika  
Mobil: +420 731 018 782

AIMCO CORPORATE HEADQUARTERS  
10000 SE Pine Street  
Portland, Oregon 97216  
Phone: (503) 254-6600  
Toll Free: 1-800-852-1368

AIMCO CORPORATION DE MEXICO SA DE CV  
Ave. Cristobal Colon 14529  
Chihuahua, Chihuahua. 31125  
Phone: (01-614) 380-1010  
Fax: (01-614) 380-1019



[www.AIMCO-GLOBAL.com](http://www.AIMCO-GLOBAL.com)

PRINTED IN THE U.S.A.

LIT-AT100, REV 07-21-23, ©2023 AIMCO